



**FISKER**  
INSTRUMENTS

Manufacturers & Exporters of Surgical, Dental, Manicure,  
Veterinary , Eye , TC , Single & Hollowware Instruments



Catalogue  
**SURGICAL**  
Instruments



**FISKER**  
INSTRUMENTS

## Surgical Instruments

Diagnostics



**Buck**

**FI-1-101-18**

Percussion Hammer

18.5 cm



**Buck**

**FI-1-102-18**

Percussion Hammer

20cm

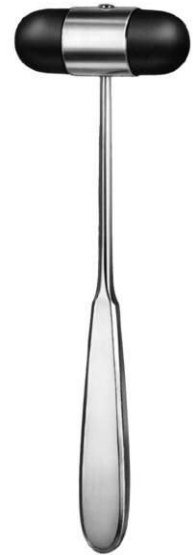

**Dejerine**

**FI-1-103-20**

Percussion Hammer

20cm



**Dejerine**

**FI-1-104-21**

Percussion Hammer

21cm



**Taylor Mod. USA**

**FI-1-105-20**

Percussion Hammer

20cm



**Wartenberg**

**FI-1-106-19**

Pinwheel

18 cm



**FISKER**  
INSTRUMENTS

## Surgical Instruments

Diagnostics



**Pinard**

**FI-1-107-18**

Stethoscope

18 cm



**Pinard**

**FI-1-108-15**

Stethoscope

15cm



**FISKER**  
INSTRUMENTS

## Surgical Instruments

Anesthesia



### Magill

**FI-2-101-15**

Catheter Introducing Forceps  
14.5 cm , 20cm, 25 cm



### Miller

**FI-1-101-18**

Laryngoscope Sets



### Millar-Baby

**FI-2-103-00**

Laryngoscope Sets



### Miller

**FI-2-104-00**

Laryngoscope Blade  
Fig. 0, Fig. 1, Fig. 2, Fig. 3, Fig. 4



### Guedel-Negus

**FI-2-105-00**

Laryngoscope Sets  
Fig. 2, Fig. 3, Fig. 4



### Guedel-Negus

**FI-2-106-00**

Laryngoscope Sets  
Fig. 1, Fig. 2, Fig. 3, Fig. 4



**FISKER**  
INSTRUMENTS

## Surgical Instruments

Anesthesia



### Guedel-Negus

**FI-2-107-01**

Laryngoscope Blades  
Fig. 1, Fig. 2, Fig. 3, Fig. 4



### McIntosh

**FI-2-108-00**

McIntosh



### McIntosh

**FI-2-109-0**

Laryngoscope Blades  
Fig. 0, Fig. 1, Fig. 2, Fig. 3, Fig. 4



### McIntosh

**FI-2-110-00**

Laryngoscope Sets  
Fig. 1, Fig. 2, Fig. 3, Fig. 4



### Foregger

**FI-2-111-01**

Laryngoscope Blades  
Fig. 1, Fig. 2, Fig. 3, Fig. 4



### Battery Handle

**FI-2-112-00**

Battery Handle



**FISKER**  
INSTRUMENTS



**McIntosh**

**FI-2-114-00**

Laryngoscope Sets fiber optic

Fig. 1, Fig. 2, Fig. 3



**McIntosh**

**FI-2-115-00**

Laryngoscope Sets fiber optic

Fig. 1, Fig. 2, Fig. 3



**McIntosh**

**FI-2-116-00**

Laryngoscope Sets fiber optic

Fig. 1, Fig. 2, Fig. 3



**McIntosh**

**FI-2-113-00**

Laryngoscope Sets

Fig. 1, Fig. 2, Fig. 3, Fig. 4



**FISKER**  
INSTRUMENTS

## Surgical Instruments

Trocars



**Universal**

**FI-3-101-04**

Trocar  
14 cm



**Nelson**

**FI-3-102-07**

Trocar  
20cm



**Lichtwitz**

**FI-3-103-19**

Antrum Trocar  
18.5 cm



**Adson**

**FI-3-104-21**

Suction Cannula  
20cm



**Frazier**

**FI-3-105-10**

Suction Cannula  
24 cm



**Frazier**

**FI-3-106-06**

Suction Cannula  
19.5 cm



**FISKER**  
INSTRUMENTS

## Surgical Instruments

Trocars



### Poppen

**FI-3-107-06**

Suction Cannula  
18 cm



### Luer

**FI-3-108-30**

Suction Tube working length 110 mm



### Yasargil

**FI-3-109-15**

Suction Tube working length 150 mm with Luer  
hub



### Yankauer

**FI-3-110-27**

Suction Tube complete with suction tip and  
connector  
31 cm



### Yankauer

**FI-3-111-00**

Suction Tube  
31 cm , 15 cm, 2.5 cm, 10 cm



### Poole

**FI-3-112-22**

Suction Tube  
22cm





**FISKER**  
INSTRUMENTS

## Surgical Instruments

Trocars



**Poole**  
**FI-3-113-22**  
Suction Tube  
22.5 cm



**Nuboer**  
**FI-3-114-21**  
Suction Tube  
21cm



**Nuboer**  
**FI-3-115-21**  
Suction Tube  
21cm



**Quinke**  
**FI-3-116-10**  
Lumbar Puncture Needle



**Tuohy**  
**FI-3-117-12**  
Lumbar Puncture Needle Luer Lock connection  
with special tip



**Verres**  
**FI-3-118-20**  
Insufflation Cannula Luer Lock connection  
15 cm



**FISKER**  
INSTRUMENTS



**Verres**

**FI-3-119-20**

Insufflation Cannula Luer Lock connection

17 cm



**FISKER**  
INSTRUMENTS

# Surgical Instruments

Suture



**Kalt**

**FI-4-105-14**

Needle Holder  
13.5 cm



**Barraquer-Troutman**

**FI-4-106-10**

Micro Needle Holder  
10 cm , 10.5 cm



**Arruga**

**FI-4-107-14**

Micro Needle Holder  
13.5 cm



**Barraquer-Troutman**

**FI-4-108-10**

Micro Needle Holder  
10.5 cm , 11.5cm



**Barraquer**

**FI-4-109-11**

Micro Needle Holder  
11.5cm, 13.5 cm , 14 cm



**Barraquer**

**FI-4-110-13**

Micro Needle Holder  
13.5 cm



**FISKER**  
INSTRUMENTS

## Surgical Instruments

Suture



### Castroviejo-Fino

**FI-4-111-01**

Micro Needle Holder  
13cm



### Castroviejo-Fino

**FI-4-112-01**

Micro Needle Holder  
13cm



### Castroviejo-Fino

**FI-4-113-01**

very delicate jaw with lock  
13cm



### Castroviejo

**FI-4-114-14**

Micro Needle Holder with lock  
Fig.65, Fig.69, Fig.88 L, 14 cm



### Castroviejo

**FI-4-115-14**

Micro Needle Holder  
14 cm



### Castroviejo

**FI-4-121-14**

Micro Needle Holder with lock  
14 cm



**FISKER**  
INSTRUMENTS

## Surgical Instruments

Suture



**Castroviejo**  
**FI-4-122-14**

Micro Needle Holder  
14 cm



**Castroviejo**  
**FI-4-124-13**

Micro Needle Holder with lock



**Arruga**  
**FI-4-123-16**

Needle Holder delicate  
16 cm



**Castroviejo**  
**FI-4-125-12**

Micro Needle Holder with lock  
12 cm



**Derf**

**FI-4-126-12**

Needle Holder  
12 cm, 13cm

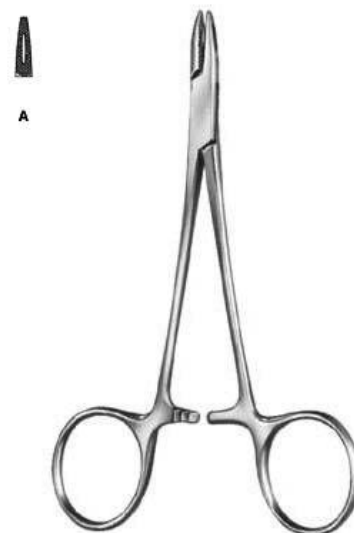

**Collier**

**FI-4-127-12**

Needle Holder  
12.5 cm



**FISKER**  
INSTRUMENTS

# Surgical Instruments

Suture



**Webster**

**FI-4-128-13**

Needle Holder  
13cm



**Halsey**

**FI-4-129-13**

Needle Holder  
13.5 cm

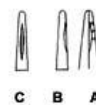

**Neivert**

**FI-4-130-13**

Neivert  
12.5 cm



**Metzenbaum**

**FI-4-141-18**

Needle Holder one grooved and fenestrated jaw  
18.5 cm



**M. G. Hospital**

**FI-4-142-17**

Needle Holder  
17.5 cm



**Mayo-Hegar**

**FI-4-143-14**

Needle Holder  
14.5 cm , 16 cm , 18.5 cm , 24 cm



**FISKER**  
INSTRUMENTS

# Surgical Instruments

Suture



**Adson**

**FI-4-140-18**

Needle Holder one fenestrated jaw  
18 cm



**Metzenbaum**

**FI-4-141-18**

Needle Holder one grooved and fenestrated jaw  
18.5 cm



**M. G. Hospital**

**FI-4-142-17**

Needle Holder  
17.5 cm

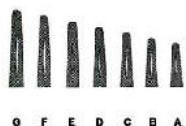

**Mayo-Hegar**

**FI-4-143-14**

Needle Holder

14.5 cm , 16 cm , 18.5 cm , 20.5 cm , 24 cm , 26.5 cm



**Brown**

**FI-4-145-13**

Needle Holder

13cm, 18 cm



**Mayo Hegar**

**FI-4-144-16**

Needle Holder

16 cm , 18.5 cm , 20.5 cm



**FISKER**  
INSTRUMENTS

## Surgical Instruments

Suture

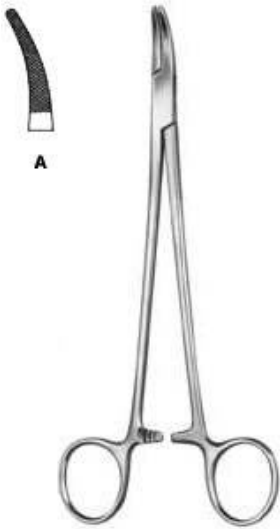

### Heaney

FI-4-146-21

Needle Holder

20.5 cm

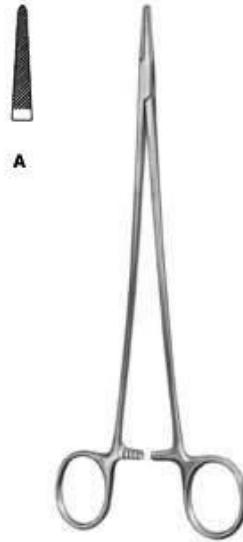

### Jamison

FI-4-147-23

Needle Holder

23.5 cm



### Masson

FI-4-148-27

Needle Holder

26.5 cm

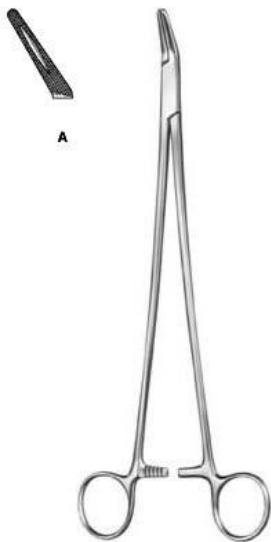

### Finochietto

FI-4-149-27

Needle Holder

26.5 cm



### Wangensteen

FI-4-150-27

Needle Holder

26.5 cm

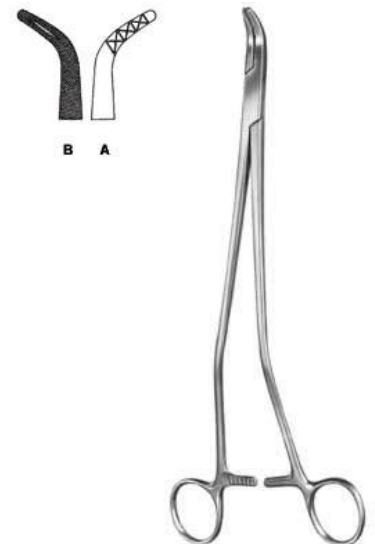

### Johnson

FI-4-151-27

Needle Holder

27 cm





**Stratte**

**FI-4-152-23**

Needle Holder  
23 cm



**Olsen-Hegar**

**FI-4-153-14**

Needle Holder  
14 cm



**Gillies**

**FI-4-154-16**

Needle Holder  
16 cm



**Crile**

**FI-155-15**

Needle Holder  
15 cm



**Mathieu**

**FI-4-156-14**

Needle Holder  
14 cm, 17 cm, 20cm



**Mathieu**

**FI-4-157-14**

Needle Holder  
16.5 cm



**FISKER**  
INSTRUMENTS

## Surgical Instruments

Suture



**Toennis**

**FI-4-158-18**

Needle Holder

18.5 cm



**Lichtenberg**

**FI-4-159-20**

Needle Holder

20cm



**Micro Needle Holder**

**FI-4-160-16**

Micro Needle Holder

16 cm

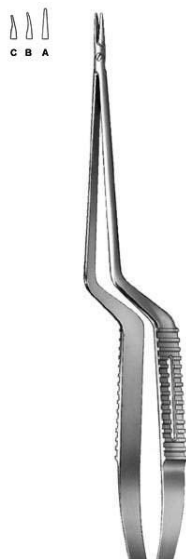

**Micro Needle Holder**

**FI-4-161**

Micro Needle Holder



**Hepp-Scheidel**

**FI-4-162-18**

Micro Needle Holder smooth jaw

18 cm



**Webster**

**FI-4-163-13**

Needle Holder with automatic release ratchet  
also for lefthanders

Fig.233, 16 cm , 12 cm , 13cm, 15 cm



**FISKER**  
INSTRUMENTS

# Surgical Instruments

Suture



**Micro Needle Holder**

**FI-4-164-15**

Micro Needle Holder  
15 cm, 18 cm, 21cm, 23 cm



**JABOMA**

**FI-4-165-18**

Micro Needle Holder  
18 cm



**Castroviejo**

**FI-4-166**

Micro Needle Holder  
Fig.233, 16 cm , 12 cm, Fig.18 L, 14.5 cm , 18 cm,  
21cm



**Arruga**

**FI-4-167**

Needle Holder  
Fig.233, 16 cm , 12 cm, Fig.18 L, 16 cm



**Castroviejo**

**FI-4-168-13**

Micro Needle Holder  
12.5 cm

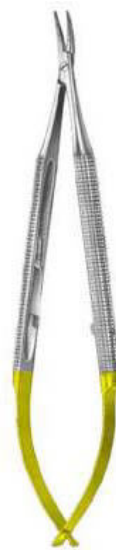

**Barraquer**

**FI-4-169-13**



**FISKER**  
INSTRUMENTS

## Surgical Instruments

Suture



**Barraquer**  
FI-4-170-13

Micro Needle Holder



**Webster**  
FI-4-171-13

Needle Holder



**Derf**  
FI-4-173-12

Needle Holder  
12 cm

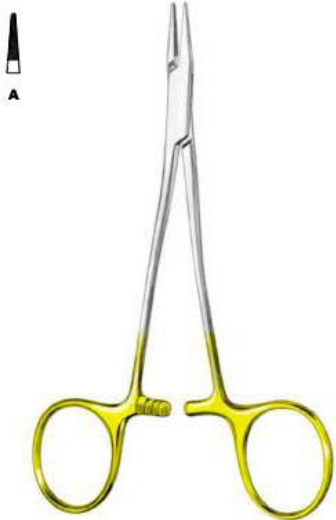

**Kilner**  
FI-4-172-13



**Hegar-Baumgartner**  
FI-4-174-13

Needle Holder  
14.5 cm



**Halsey**  
FI-4-175-12

Needle Holder  
12 cm



**Crile-Wood**

**FI-4-176-15**

Needle Holder  
15 cm



**Sarot**

**FI-4-177-18**

Needle Holder

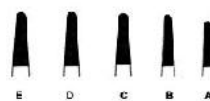

**Mayo-Hegar**

**FI-4-178-16**

Needle Holder standard profile  
24 cm , 30 cm



**Heaney**

**FI-4-179-20**

Needle Holder  
24 cm

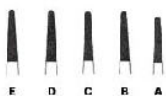

**DeBakey**

**FI-4-180-18**

Needle Holder delicate pattern mini profile



**Masson**

**FI-4-181-27**

Needle Holder  
26.5 cm



**FISKER**  
INSTRUMENTS

## Surgical Instruments

Suture

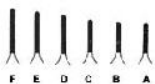

**Ryder (Martin)**

**FI-4-182-13**

Needle Holder  
12.5 cm, 15 cm



**Martin**

**FI-4-183-15**

Needle Holder mini profile elastic type  
15 cm, 17 cm



**Wangenstein**

**FI-4-184-27**

Needle Holder standard profile  
27 cm

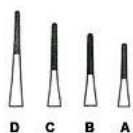

**Hegar-Vascular**

**FI-4-185-14**

Needle Holder micro profile  
14 cm, 18.5 cm, 20.5 cm

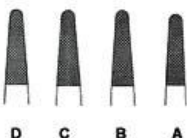

**Bozemann**

**FI-4-186-20**

Needle Holder standard profile  
20.5 cm, 24 cm, 26.5 cm



**Hegar**

**FI-4-187-20**

Needle Holder standard profile



**FISKER**  
INSTRUMENTS

## Surgical Instruments

Suture



### Stratte

FI-4-188-22

Needle Holder standard profile

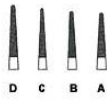

### Microvascular

FI-4-189-00

Needle Holder slender pattern micro profile  
14 cm, 17.5 cm



### Mathieu

FI-4-190-14

Needle Holder  
14 cm, 17 cm



### Mathieu

FI-4-191-14

Needle Holder  
14 cm, 17 cm



### Mathieu

FI-4-192-17

Needle Holder standard profile with interior  
ratchet  
17 cm



### Toennis

FI-4-193-18

Needle Holder  
18.5 cm



**FISKER**  
INSTRUMENTS

# Surgical Instruments

Suture



**Lichtenberg**  
**FI-4-194-20**

Needle Holder lightweight model standard profile



**Langenbeck**  
**FI-4-195-18**

Needle Holder  
20.5 cm



**Zweifel**  
**FI-4-196-20**

Needle Holder with hinged ratchet standard  
profile  
20.5 cm



**Reverdin**  
**FI-4-197-15**

Reverdin Needle short

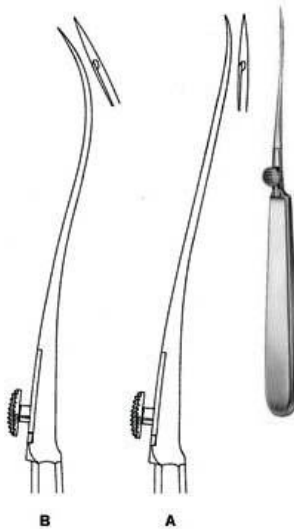

**Reverdin**  
**FI-4-198-19**

Reverdin Needle medium

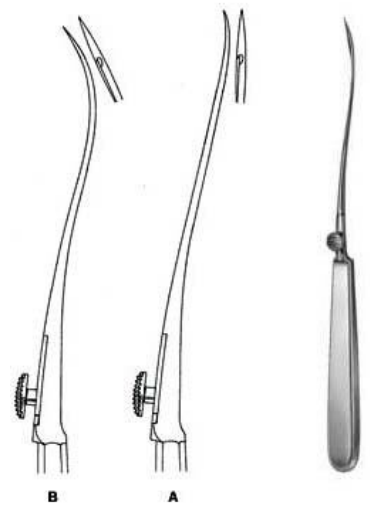

**Reverdin**  
**FI-4-199-23**

Reverdin Needle long





**FISKER**  
INSTRUMENTS

## Surgical Instruments

Suture

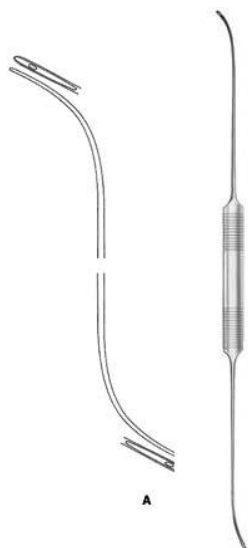

### Schmieden-Dick

FI-4-201-01

Ligature Needle malleable

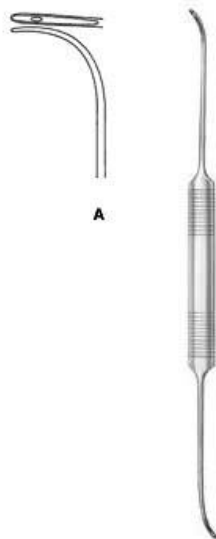

### Schmieden

FI-4-202-21

Ligature Needle  
24 cm



### Ligature Needle Malleable

FI-4-203-20

Ligature Needle malleable  
20.5 cm

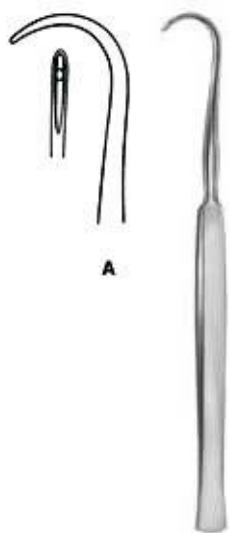

### Cooper

FI-4-204-19

Ligature Needle  
18.5 cm



### Kronecker

FI-4-205-13

Ligature Needle delicate for right hand  
12.5 cm

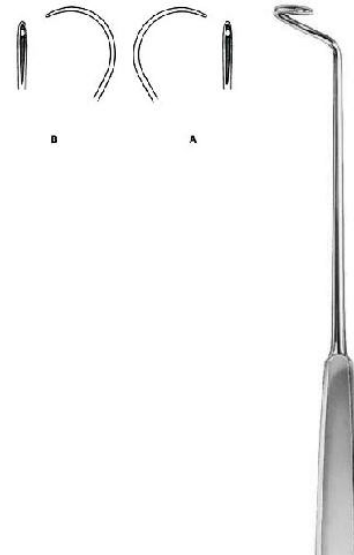

### Deschamps

FI-4-206-24

24 cm



**FISKER**  
INSTRUMENTS

# Surgical Instruments

Suture



## Deschamps

**FI-4-207-20**

Ligature Needle blunt for right hand



## Deschamps

**FI-4-208-20**

Ligature Needle sharp for right hand

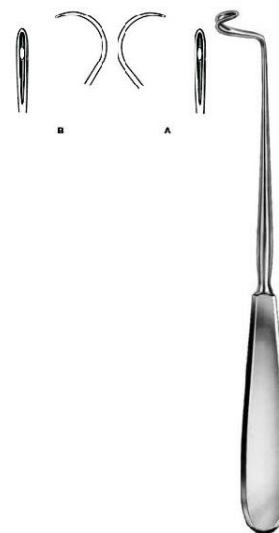

## Deschamps

**FI-4-209-21**

Ligature Needle blunt for right hand

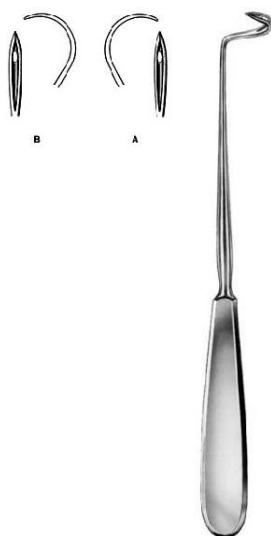

## Deschamps

**FI-4-210-21**

Ligature Needle sharp for right hand

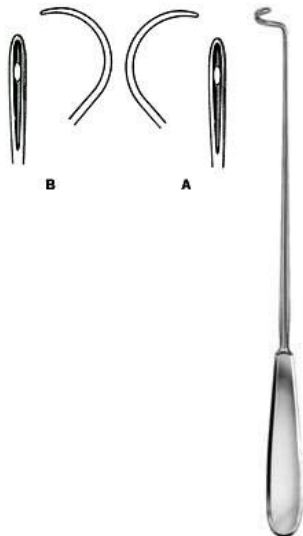

## Deschamps

**FI-4-211-27**

Ligature Needle blunt for right hand  
27 cm

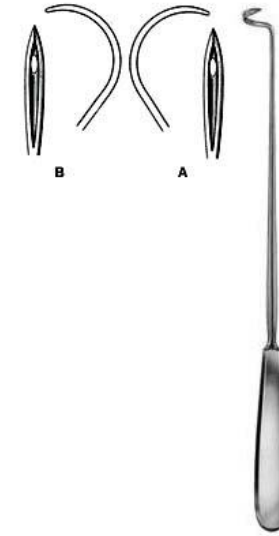

## Deschamps

**FI-4-212-27**

Ligature Needle sharp for right hand  
27 cm



**FISKER**  
INSTRUMENTS

## Surgical Instruments

Suture

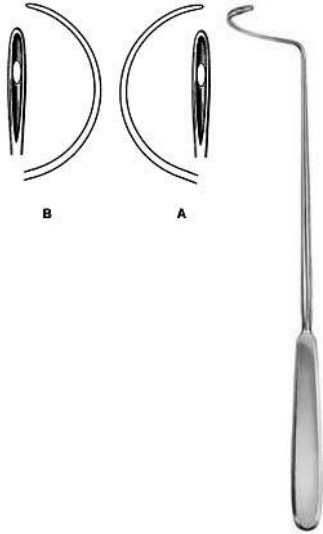

**Deschamps**  
FI-4-213-28

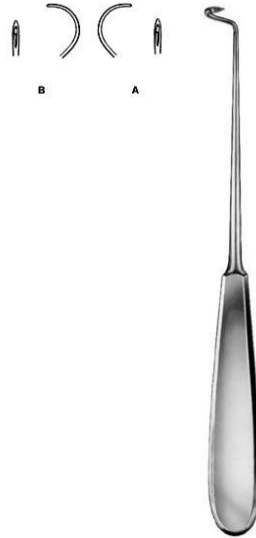

**Deschamps**  
FI-4-214-20  
Ligature Needle sharp for right hand



**Deschamps**  
FI-4-215-20  
Ligature Needle blunt for right hand



**Deschamps**  
FI-4-216-20  
Ligature Needle blunt for right hand

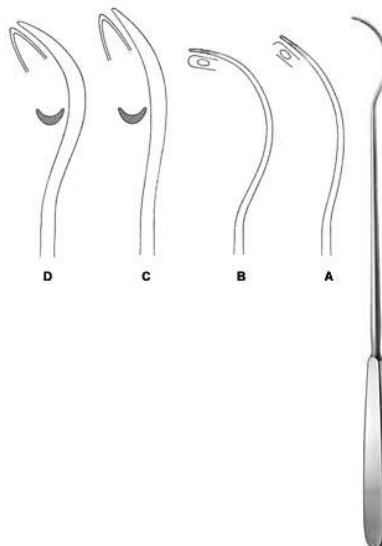

**Brunner**  
FI-4-217-30  
Ligature Needle



**Kirschner**  
FI-4-218-25  
Ligature Conductor



**FISKER**  
INSTRUMENTS

## Surgical Instruments

Suture

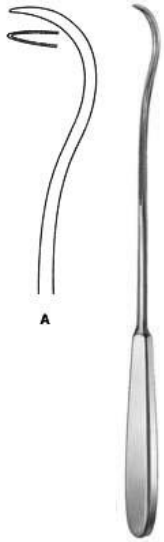

### Ligature Conductor

**FI-4-219-28**

Ligature Conductor



### Modell Wien

**FI-4-220-23**

Ligature Catcher  
23.5 cm



### Michel

**FI-4-221-12**

Clip Applying Forceps  
12 cm



### Hegenbarth

**FI-4-222-12**

Clip Applying Forceps  
12 cm



**FISKER**  
INSTRUMENTS

## Surgical Instruments

Scalpels



### Dissecting Knife

**FI-5-101-01**

Dissecting Knife with metal handle  
15 cm, 15.5 cm, 16 cm, 17 cm



### Autopsy Knife

**FI-5-102-10**

Autopsy Knife  
25.5 cm

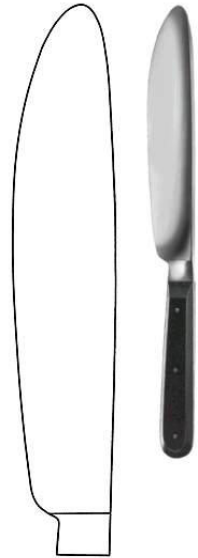

### Walb

**FI-5-104-17**

Post Mortem Knife

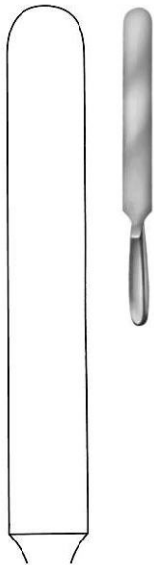

### Virchow

**FI-5-105-20**

28.5 cm, 33.5 cm, 38 cm



### Scalpel Handle

**FI-5-108-04**

Scalpel Handle  
13.5 cm



### Scalpel Handle

**FI-5-109-34**

Scalpel Handle  
16 cm



**FISKER**  
INSTRUMENTS

## Surgical Instruments

Scalples



### Scalpel Handle

**FI-5-110-41**

Scalpel Handle  
21cm



### Scalpel Handle

**FI-5-111-45**

Scalpel Handle  
21cm



### Collin

**FI-5-112-08**

Scalpel Handle with hollow handle  
13.5 cm



### Collin

**FI-5-113-09**

Scalpel Handle with hollow handle  
14.5 cm



### Scalpel Handle

**FI-5-114-03**

Scalpel Handle  
12 cm



### Scalpel Handle

**FI-5-115-04**

Scalpel Handle  
12 cm



**FISKER**  
INSTRUMENTS

## Surgical Instruments

Scalpels



### Scalpel Handle

**FI-5-116-05**  
Scalpel Handle  
12 cm



### Scalpel Handle

**FI-5-117-31**  
Scalpel Handle  
21.5 cm



### Scalpel Handle

**FI-5-118-35**  
Scalpel Handle  
21cm



### Scalpel Handle

**FI-5-119-07**  
Scalpel Handle  
16 cm



### Scalpel Handle

**FI-5-120-71**  
Scalpel Handle  
12.5 cm



### Scalpel Handle

**FI-5-121-03**  
Scalpel Handle  
15.5 cm



**FISKER**  
INSTRUMENTS

## Surgical Instruments

Scalpels



### Amputation Knife

**FI-5-127-16**

Amputation Knife  
29 cm



### Amputation Knife

**FI-5-128-19**

Amputation Knife  
32.5 cm



### Catlin

**FI-5-129-16**

Interosseous Knife with hollow handle  
29 cm



### Resection Knife

**FI-5-130-06**

Resection Knife  
18 cm



### Langenbeck

**FI-5-131-05**

Resection Knife  
18 cm



### Langenbeck

**FI-5-132-05**

18 cm





**FISKER**  
INSTRUMENTS

## Surgical Instruments

Scalpels



### Razor Knife

**FI-5-133-00**

Razor Knife hollow blades on both sides cutting length 75mm



### Schink

**FI-5-134-00**

Dermatome complete with 2 skin fixing plates and one blade 31 cm



### Schink

**FI-5-135-01**

Spare Blade spare blade for KE-05-134-00



### Schink

**FI-5-136-02**

Skin Fixing Plate for KE-05-134-00



**FISKER**  
INSTRUMENTS

## Surgical Instruments

Scissors



**Standard BL / BL Straight**

**FI-5-201-13**

Operating Scissor Special Price: \$1.25  
12 cm, 13cm, 14.5 cm , 16.5 cm , 18.5 cm , 20.5 cm



**Standard SH / BL STR**

**FI-5-202-13**

Operating Scissors  
12 cm, 13cm, 14.5 cm , 16.5 cm , 18.5 cm , 20.5 cm



**Standard SH / SH STR**

**FI-5-204-13**

Operating Scissors  
12 cm, 13cm, 14.5 cm , 16.5 cm



**Standard BL / BL Curved**

**FI-5-205-13**

Operating Scissors  
12 cm, 13cm, 14.5 cm , 16.5 cm , 18.5 cm , 20.5 cm

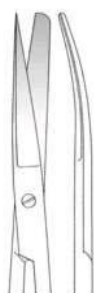

**Standard SH / BL Curved**

**FI-5-206-13**

Operating Scissors  
12 cm, 13cm, 14.5 cm , 16.5 cm , 18.5 cm , 20.5 cm



**Standard SH / SH Curved**

**FI-5-207-13**

Operating Scissors  
12 cm, 13cm, 14.5 cm , 16.5 cm



**FISKER**  
INSTRUMENTS

## Surgical Instruments

Scissors



**Standard BL / BL Curved**

**FI-5-208-14**

Operating Scissors delicate  
14.5 cm



**Incision Scissor**

**FI-5-209-14**

Operating Scissor  
14.5 cm



**Deaver**

**FI-5-210-14**

Operating Scissor



**Mayo**

**FI-5-211-15**

Dissecting Scissors  
14.5 cm , 15 cm , 17 cm , 23.5 cm



**Mayo**

**FI-5-212-23**

Dissecting Scissors  
23 cm , 22.5 cm , 28 cm



**Mayo-Harrington**

**FI-5-213-22**

Dissecting Scissors  
23 cm , 22.5 cm , 28 cm



**FISKER**  
INSTRUMENTS

## Surgical Instruments

Scissors

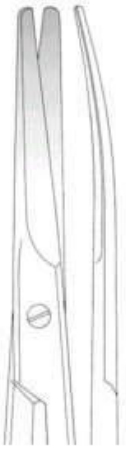

### Mayo-Harrington

**FI-5-214-22**

Dissecting Scissors cur  
22.5 cm, 23 cm, 28 cm



### Mayo-Stillle

**FI-5-215-17**

Dissecting Scissors str  
15 cm, 17 cm



### Mayo-Stillle

**FI-5-216-15**

Dissecting Scissors cur  
15 cm, 17 cm



### Mayo-Stillle

**FI-5-217-19**

Dissecting Scissors cur  
16 cm, 19.5 cm, 21.5 cm



### Mayo-Stillle

**FI-5-218-16**

Dissecting Scissors cur  
16 cm, 19.5 cm, 21.5 cm



### Mayo-Noble

**FI-5-219-17**

Gynecological Scissors  
16.5 cm



**FISKER**  
INSTRUMENTS

## Surgical Instruments

Scissors



**Sims**

**FI-5-220-23**

Gynecological Scissors str  
20cm, 23 cm



**Sims**

**FI-5-221-20**

Gynecological Scissors cur  
20cm, 23 cm



**Kelly**

**FI-5-222-16**

Operating Scissors  
16 cm



**Doyen**

**FI-5-223-17**

Gynecological Scissors  
18.5 cm



**Sims-Siebold**

**FI-5-224-24**

Gynecological Scissors  
24.5 cm



**Sims-Siebold**

**FI-5-225-24**

Gynecological Scissors  
24.5 cm



**FISKER**  
INSTRUMENTS

## Surgical Instruments

Scissors



**Wertheim**

**FI-5-226-23**

Gynecological Scissors  
20cm, 23 cm



**Metzenbaum**

**FI-5-227-11**

Dissecting Scissors  
11



**Metzenbaum**

**FI-5-228-14**

Dissecting Scissors  
14.5 cm

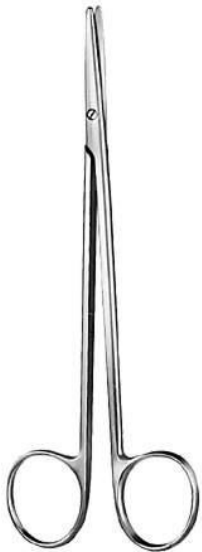

**Metzenbaum**

**FI-5-229-15**

Dissecting Scissors  
15.5 cm



**Metzenbaum-Nelson**

**FI-5-230-20**

Dissecting Scissors  
18 cm, 20.5 cm, 23 cm , 26 cm, 28.5 cm, 31 cm



**Metzenbaum-Nelson**

**FI-5-231-20**

Dissecting Scissors  
18 cm, 20.5 cm



**FISKER**  
INSTRUMENTS

## Surgical Instruments

Scissors



### Metzenbaum-Nelson

**FI-5-232-20**

Dissecting Scissors

18 cm, 20.5 cm, 23 cm, 26 cm, 28.5 cm, 31 cm



### Metzenbaum

**FI-5-233-14**

Dissecting Scissors toothed

14.5 cm



### Nerve Operating Scissor

**FI-5-234-15**

Dissecting Scissors

15.5 cm

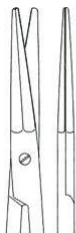

### Gorney

**FI-5-235-19**

Face-lift Scissors str

12.5 cm, 19.5 cm

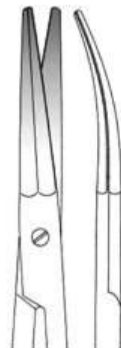

### Gorney

**FI-5-236-19**

Face-lift Scissors cur

19.5 cm



### Aston

**FI-5-237-17**

Face-lift Scissors

17 cm



**FISKER**  
INSTRUMENTS

## Surgical Instruments

Scissors

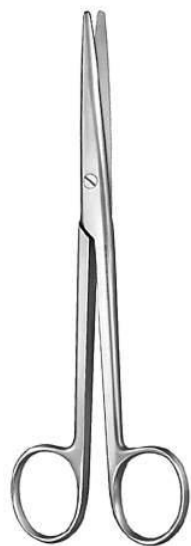

**Lexer**  
**FI-5-238-16**  
Dissecting Scissors  
16 cm



**Cinelli**  
**FI-5-239-14**  
Nasal Scissors  
11.5cm, 14 cm



**Thorek**  
**FI-5-240-19**  
Dissecting Scissors  
18.5 cm



**Lexer-Baby**  
**FI-5-241-10**  
Dissecting Scissors  
10 cm



**Lexer-Fino**  
**FI-5-242-16**  
Delicate Dissecting Scissors slender pattern  
16.5 cm



**Metzenbaum-Fino**  
**FI-5-243-14**  
Delicate Dissecting Scissors slender pattern  
14.5 cm





**FISKER**  
INSTRUMENTS

## Surgical Instruments

Scissors



**Metzenbaum-Fino**

**FI-5-244-14**

Delicate Dissecting Scissors  
14.5 cm



**Metzenbaum-Fino**

**FI-5-245-14**

Delicate Dissecting Scissors  
14.5 cm



**Metzenbaum-Fino**

**FI-5-246-14**

Delicate Dissecting Scissors  
14.5 cm

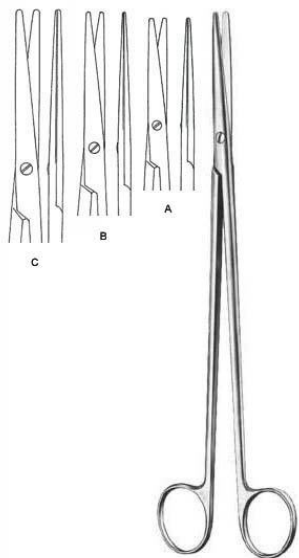

**Metzenbaum-Fino**

**FI-5-247-18**

Delicate Dissecting Scissors slender pattern  
18 cm, 20cm, 23 cm

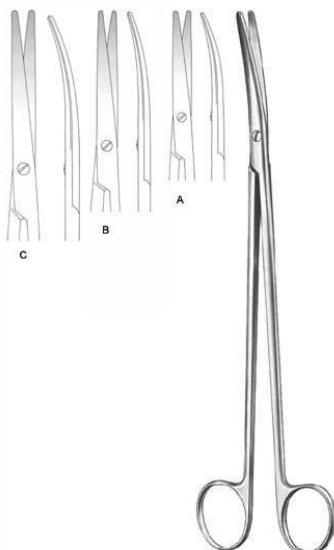

**Metzenbaum-Fino**

**FI-5-248-18**

Delicate Dissecting Scissors slender pattern  
18 cm, 20cm, 23 cm

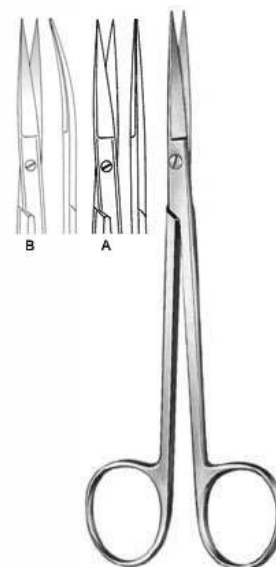

**Sanvenero**

**FI-5-250-14**

Operating Scissors  
14 cm



**FISKER**  
INSTRUMENTS

## Surgical Instruments

Scissors

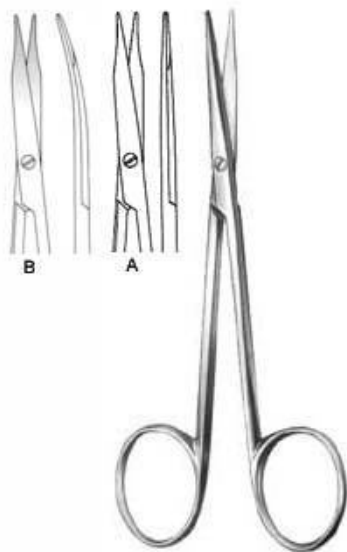

### Fine Operating Scissors

**FI-5-251-11**

Fine Operating Scissors  
11.5cm

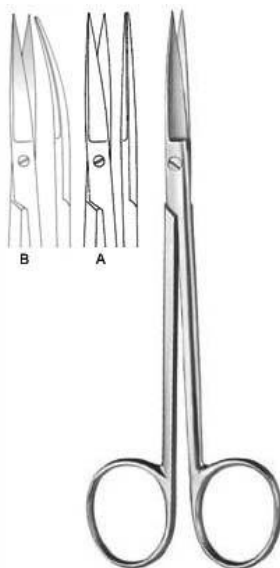

### Joseph

**FI-5-252-14**

Operating Scissors  
14.5 cm

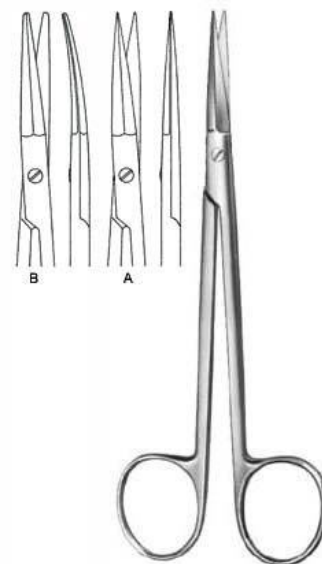

### Peck-Joseph

**FI-5-253-14**

Face-lift Scissors  
14.5 cm

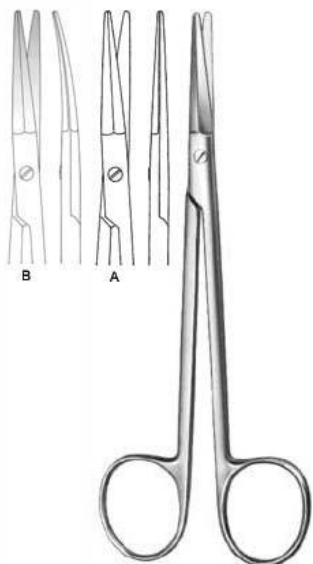

### Peck-Joseph

**FI-5-254-14**

Face-lift Scissors  
14.5 cm



### Shea Vein Graft

**FI-5-255-12**

Dissecting Scissors  
12 cm

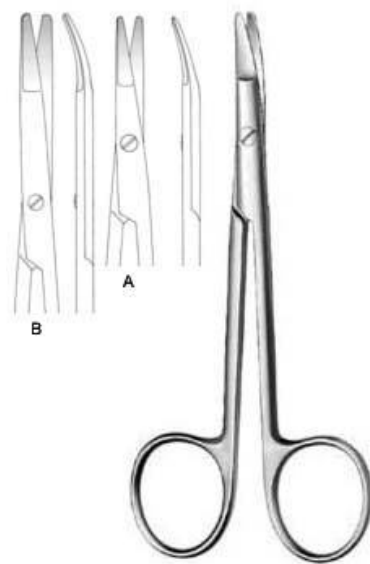

### Kilner

**FI-5-256-12**

Dissecting Scissors  
12 cm, 15 cm



**FISKER**  
INSTRUMENTS

## Surgical Instruments

Scissors

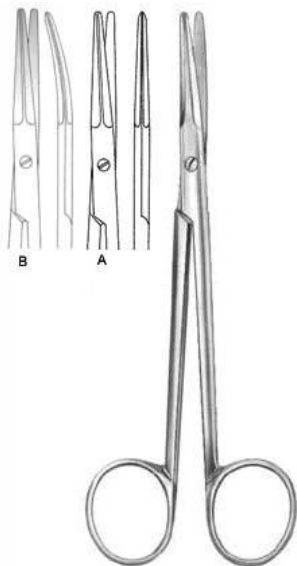

### Dissecting Scissors

**FI-5-257-14**

Dissecting Scissors  
14.5 cm

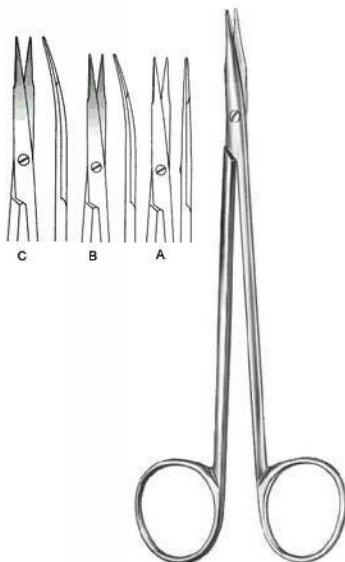

### Reynolds

**FI-5-258-15**

Dissecting Scissors  
14.5 cm, 18 cm



### Jameson

**FI-5-259-14**

Dissecting Scissors  
15.5 cm



### Jameson

**FI-5-260-14**

Dissecting Scissors  
15.5 cm



### Vascular Scissors

**FI-5-261-19**

Vascular Scissors  
19 cm



### Vascular Scissors

**FI-5-262-24**

Vascular Scissors  
19 cm, 25.5 cm



**FISKER**  
INSTRUMENTS

# Surgical Instruments

Scissors

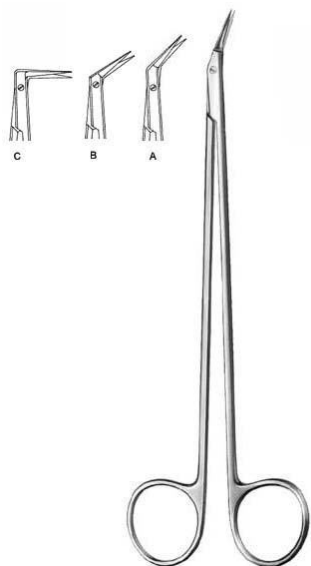

**Diethrich**

**FI-5-263-25**

ascular Scissors

17.5 cm, 18.5 cm , 19 cm

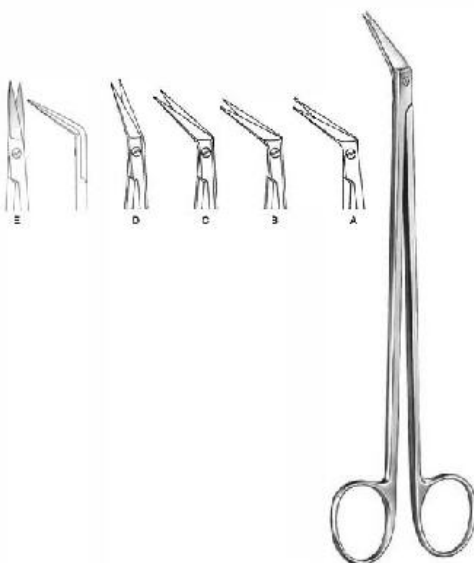

**DeBakey**

**FI-5-264-45**

ascular Scissors

16 cm, 16.5 cm

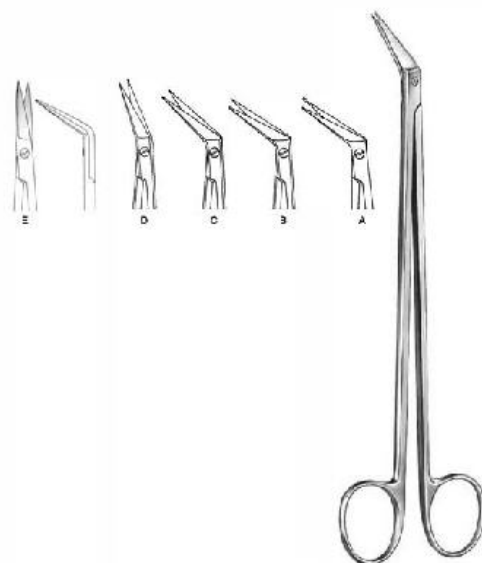

**Potts-Smith**

**FI-5-265-19**

Vascular Scissors

18 cm, 18.5 cm , 19 cm



**Coronary Scissors**

**FI-5-267-45**

Cardiovascular Surgery Scissors

18 cm



**Coronary Scissors**

**FI-5-267-45**

Cardiovascular Surgery Scissors

18 cm



**Coronary Scissors**

**FI-5-268-60**

Cardiovascular Surgery Scissor

18 cm



**FISKER**  
INSTRUMENTS

## Surgical Instruments

Scissors



### Coronary Scissors

**FI-5-269-90**

Cardiovascular Surgery Scissor

18 cm



### Coronary Scissors

**FI-5-270-00**

Cardiovascular Surgery Scissor

18 cm



### Coronary Scissors

**FI-5-271-00**

Cardiovascular Surgery Scissor

18 cm

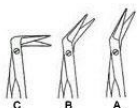

### Coronary Scissors

**FI-5-272-25**

Cardiovascular Surgery Scissor

18 cm



### Coronary Scissors

**FI-5-273-45**

Cardiovascular Surgery Scissor

18 cm



### Coronary Scissors

**FI-5-274-90**

Cardiovascular Surgery Scissor

18 cm



**FISKER**  
INSTRUMENTS

## Surgical Instruments

Scissors



**Schmieden-Taylor**

**FI-5-275-17**

Dura Scissors  
15 cm



**Strully**

**FI-5-276-22**

Neurosurgical Scissors  
22.5 cm



**Toennis-Adson**

**FI-5-277-17**

Dissecting Scissors  
17.5 cm



**Good**

**FI-5-279-19**

Tonsil Scissors  
19.5 cm



**Fomon**

**FI-5-282-15**

Nasal Scissors  
15 cm



**Cottle**

**FI-5-283-16**

Nasal Scissors  
16 cm



**FISKER**  
INSTRUMENTS

## Surgical Instruments

Scissors



**Heymann**

**FI-5-284-18**

Nasal Scissors

18.5 cm



**Heymann**

**FI-5-285-18**

Nasal Scissors

18.5 cm



**Converse**

**FI-5-286-11**

Nasal Scissors blunt & sharp

10.5 cm



**Waldmann**

**FI-5-287-18**

Episiotomy Scissors

18 cm



**Braun-Stadler**

**FI-5-268-60**

Episiotomy Scissors

14.5 cm



**Braun-Stadler**

**FI-5-289-22**

Episiotomy Scissors

22cm



**FISKER**  
INSTRUMENTS

## Surgical Instruments

Scissors



**Modell USA**

**FI-5-290-10**

Umbilical Scissors

10.5 cm



**Busch**

**FI-5-292-16**

Umbilical Scissors

16 cm



**Goldmann-Fox**

**FI-5-293-13**

Gum Scissors

13cm



**Wagner**

**FI-5-294-12**

Operating Scissors

12 cm

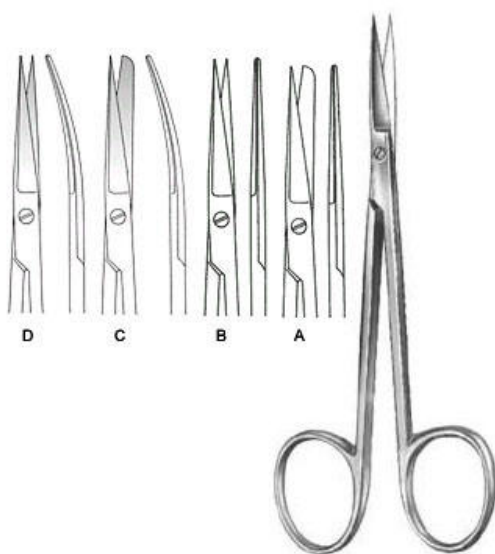

**Operating Scissors**

**FI-5-295-12**

Operating Scissors small model

12 cm



**La Grange**

**FI-5-296-11**

Gum Scissors S-shaped

11.5cm





**FISKER**  
INSTRUMENTS

## Surgical Instruments

Scissors



### Dissecting Scissors

**FI-5-297-11**

Dissecting Scissors 11.5cm  
11.5cm



### Locklin

**FI-5-298-16**

Gum Scissors 16cm  
16 cm



### Locklin

**FI-5-299-16**

Gum Scissors  
16 cm



### Operating Scissors

**FI-5-300-08**

Operating Scissors  
9

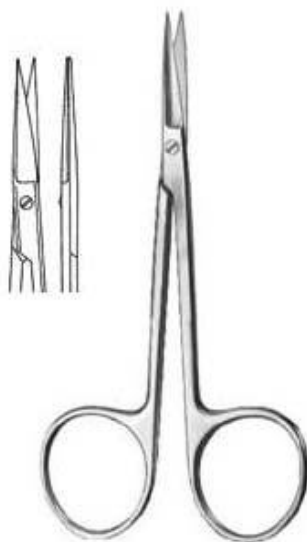

### Iris Scissors

**FI-5-301-10**

Iris Scissors  
9 cm, 10 cm

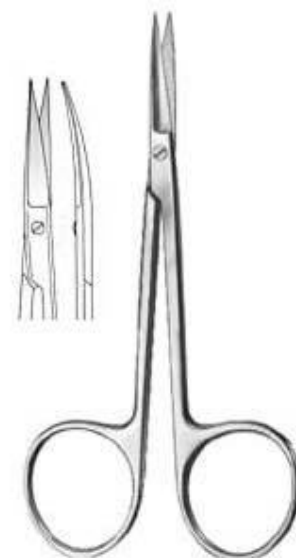

### Iris Scissors

**FI-5-302-10**

Iris Scissors  
10 cm



**FISKER**  
INSTRUMENTS

## Surgical Instruments

Scissors



**Iris Scissors**

**FI-5-303-10**

Iris Scissors  
10 cm



**Bonn**

**FI-5-304-09**

Iris Scissors



**Dean**

**FI-5-278-17**

Tonsil Scissors 17.5cm  
17.5 cm



**Spencer Scissor**

**FI-0-**

Spencer Scissor



**FISKER**  
INSTRUMENTS

## Surgical Instruments

### Dressing & Tissue Forceps



#### Standard

**FI-5-401-10**

Dressing Forceps

18.5 cm , 18.5 cm , 13cm, 14.5 cm , 16 cm, 18 cm,  
20cm, 23 cm , 25 cm , 30.5 cm



#### Standard

**FI-5-402-11**

Dressing Forceps

12 cm, 13cm, 14.5 cm , 16 cm, 18 cm, 20cm, 25  
cm , 30 cm



#### Dressing Forceps

**FI-5-403-13**

Dressing Forceps

13cm, 14.5 cm



#### Stille

**FI-5-404-15**

Dressing Forceps

15 cm



#### Mini-Adson

**FI-5-405-12**

Dressing Forceps

12 cm



#### Adson

**FI-5-406-12**

Dressing Forceps

12 cm, 15 cm



**FISKER**  
INSTRUMENTS

## Surgical Instruments

### Dressing & Tissue Forceps



**McIndoe**

**FI-5-405-12**

Dressing Forceps  
15 cm



**Vaugh**

**FI-5-408-20**

Dressing Forceps  
20cm



**Semken**

**FI-5-409-12**

Dressing Forceps  
12.5 cm, 15 cm



**Taylor**

**FI-5-410-17**

Dressing Forceps  
12.5 cm, 15 cm



**Taylor**

**FI-5-411-17**

Dressing Forceps  
17 cm



**Taylor**

**FI-5-412-17**

Dressing Forceps  
18.5 cm



**FISKER**  
INSTRUMENTS

## Surgical Instruments

Dressing & Tissue Forceps



### Dressing Forceps

**FI-5-413-06**

Dressing Forceps  
15.5 cm



### Gerald

**FI-5-414-18**

Dressing Forceps  
15.5 cm



### Cushing

**FI-5-415-17**

Dressing Forceps  
17.5 cm



### Potts-Smith

**FI-5-416-18**

Dressing Forceps  
18 cm, 21cm, 24.5 cm



### Bonney

**FI-5-417-17**

Dissecting Forceps  
17.5 cm



### Gerald

**FI-5-418-17**

17.5 cm



**FISKER**  
INSTRUMENTS

## Surgical Instruments

Dressing & Tissue Forceps



**Gillies**

**FI-5-419-15**

Dissecting Forceps  
15.5 cm



**McIndoe**

**FI-5-420-15**

Dissecting Forceps  
15 cm



**Semken**

**FI-5-421-16**

Dissecting Forceps  
15.5 cm, 17.5 cm



**Adson-Brown**

**FI-5-422-12**

Dissecting Forceps  
12 cm



**Adson**

**FI-5-423-12**

Dissecting Forceps  
16.5 cm 5.5mm , 16.5 cm 5.5mm



**Adson**

**FI-5-424-12**

Dressing Forceps  
16.5 cm 5.5mm , 16.5 cm 5.5mm



**FISKER**  
INSTRUMENTS

## Surgical Instruments

Dressing & Tissue Forceps



### Cushing

**FI-5-425-17**

Dressing Forceps  
16.5 cm 5.5mm



### Cushing

**FI-5-426-18**

Dressing Forceps  
16.5 cm 5.5mm



### Cushing-Taylor

**FI-5-427-18**

Dressing Forceps  
16.5 cm 5.5mm

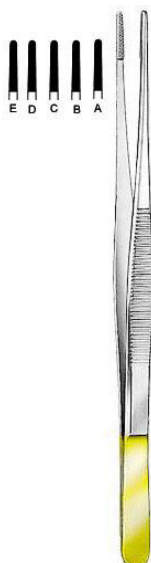

### Potts-Smith

**FI-5-428-15**

Dressing Forceps  
16 cm, 18.5 cm, 20cm, 23 cm, 25 cm



### Oehler

**FI-5-429-14**

Dissecting Forceps  
14.5 cm, 16 cm, 18 cm, 20cm, 25 cm



### Wangensteen

**FI-5-430-15**

Dressing Forceps  
15 cm, 23 cm



**FISKER**  
INSTRUMENTS

# Surgical Instruments

## Dressing & Tissue Forceps



### DeBakey

**FI-5-421-16**

Atraumatic Dressing Forceps

16 cm, 20cm, 24.5 cm



### DeBakey

**FI-5-432-16**

Atraumatic Dressing Forceps

16 cm, 20cm, 24 cm



### Dissecting Forceps

**FI-5-433-10**

Dissecting Forceps

10.5 cm , 11.5cm, 13 cm , 14.5 cm , 16 cm, 18 cm,  
20cm, 23 cm , 25 cm , 30.5 cm

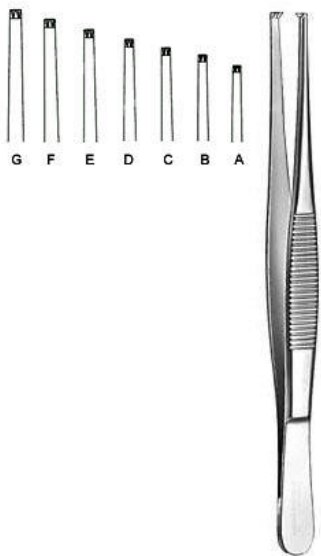

### Dissecting Forceps

**FI-5-434-11**

Dissecting Forceps

12 cm, 13 cm , 14.5 cm , 15.5 cm, 18 cm, 20cm,  
24.5 cm



### Dissecting Forceps

**FI-5-435-14**

Dissecting Forceps

14.5 cm , 16 cm



### Dissecting Forceps

**FI-5-436-14**

Dissecting Forceps

14.5 cm , 16 cm





**FISKER**  
INSTRUMENTS

## Surgical Instruments

Dressing & Tissue Forceps



### Dissecting Forceps

**FI-5-437-13**

Dissecting Forceps  
13 cm , 14.5 cm , 16 cm , 20cm



### Dissecting Forceps

**FI-5-438-13**

Dissecting Forceps  
13 cm , 14.5 cm



### Stille

**FI-5-439-15**

Dissecting Forceps  
15 cm



### Stille

**FI-5-440-15**

Dissecting Forceps  
15 cm



### Stone

**FI-5-441-15**

Dissecting Forceps  
15 cm



### Lerche

**FI-5-442-15**

Dissecting Forceps  
15 cm



**FISKER**  
INSTRUMENTS

## Surgical Instruments

Dressing & Tissue Forceps

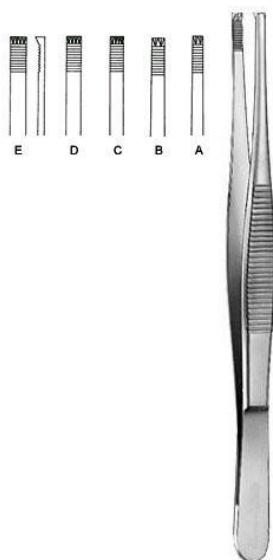

### Adlerkreutz

FI-5-443-15

Dissecting Forceps

15.5 cm, 20.5 cm, 16 cm, 20cm, 25 cm

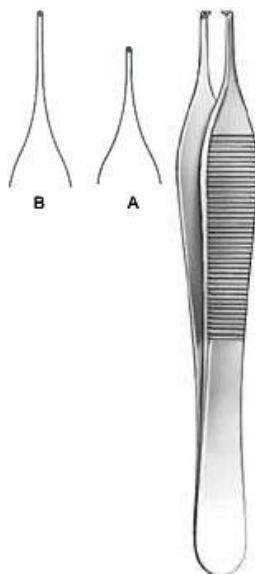

### Adson

FI-5-444-12

Dissecting Forceps

12 cm, 15 cm



### Gillies

FI-5-445-15

Dissecting Forceps

15.5 cm



### Waugh

FI-5-446-20

Dissecting Forceps

20.5 cm



### Semken

FI-5-447-12

Dissecting Forceps

12.5 cm, 15 cm



### Taylor

FI-5-448-17

Dissecting Forceps

17.5 cm



**FISKER**  
INSTRUMENTS

## Surgical Instruments

### Dressing & Tissue Forceps



#### Taylor

**FI-5-449-17**

Dissecting Forceps  
17 cm



#### Taylor

**FI-5-450-17**

Dissecting Forceps  
18.5 cm



#### Dissecting Forceps

**FI-5-451-06**

Dissecting Forceps  
15.5 cm



#### Gerald

**FI-5-452-17**

Dissecting Forceps  
17.5 cm



#### Cushing

**FI-5-453-17**

Dissecting Forceps  
18 cm



#### Potts-Smith

**FI-5-454-18**

Dissecting Forceps  
18 cm, 21cm, 24 cm



**FISKER**  
INSTRUMENTS

## Surgical Instruments

Dressing & Tissue Forceps

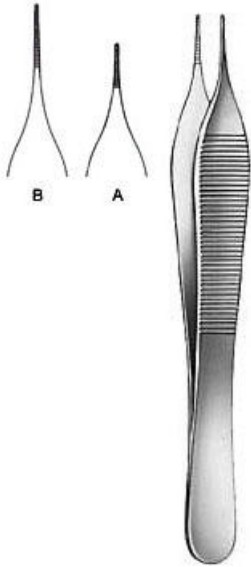

### Mikro-Adson

**FI-5-455-12**

Dressing Forceps  
12 cm, 15 cm

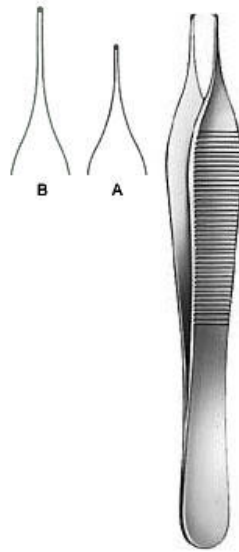

### Mikro-Adson

**FI-5-456-12**

Dissecting Forceps  
12 cm, 15 cm



### Dissecting Forceps

**FI-5-457-11**

Dissecting Forceps  
10.5 cm



### Micro Jewelers

**FI-5-458-12**

Jeweler Type Forceps  
12 cm Fig. 7



### Jewelers

**FI-5-459-12**

Jeweler Type Forceps  
12 cm Fig. 3



### Jewelers

**FI-5-460-11**

Jeweler Type Forceps  
11 cm Fig. 3c



**FISKER**  
INSTRUMENTS

## Surgical Instruments

### Dressing & Tissue Forceps



#### Jewelers

**FI-5-461-11**

Jeweler Type Forceps  
11 cm Fig. 5



#### Jewelers

**FI-5-462-11**

Jeweler Type Forceps  
11 cm Fig. 4



#### Stille-Barraya

**FI-5-463-18**

Dissecting Forceps  
18 cm



#### Bonney

**FI-5-464-18**

Dissecting Forceps  
17.5 cm



#### Nelson

**FI-5-465-23**

Dissecting Forceps  
23 cm



#### Dressing Forceps

**FI-5-466-10**

Dressing Forceps  
10 cm , 9.5 cm



**FISKER**  
INSTRUMENTS

## Surgical Instruments

Dressing & Tissue Forceps



### Splinter Forceps Smooth Jaw

**FI-5-467-12**

Splinter Forceps smooth jaw  
12.5 cm



### Splinter Forceps Smooth Jaw

**FI-5-468-12**

Splinter Forceps smooth jaw  
12.5 cm



### Splinter Forceps

**FI-5-469-12**

Splinter Forceps  
12.5 cm



### Splinter Forceps

**FI-5-470-12**

Splinter Forceps  
12.5 cm



### Micro Tying Forceps

**FI-5-471-16**

Micro Tying Forceps  
15.5 cm



### Microscopic Forceps Super Light, Blunt

**FI-5-472-10**

Microscopic Forceps super light, blunt  
10 cm



**FISKER**  
INSTRUMENTS

## Surgical Instruments

Dressing & Tissue Forceps



### Microscopic Forceps

**FI-5-473-10**

Microscopic Forceps  
10 cm



### Shaaf

**FI-5-474-09**

Splinter Forceps  
9.5 cm



### Littauer

**FI-5-475-08**

Cilia Forceps  
8.5 cm



### Cilia Forceps

**FI-5-476-09**

Cilia Forceps  
8.5 cm



### Douglas

**FI-5-477-09**

Cilia Forceps  
9 cm



### Douglas

**FI-5-478-09**

Cilia Forceps  
9 cm



**FISKER**  
INSTRUMENTS

## Surgical Instruments

Dressing & Tissue Forceps



### **Beer**

**FI-5-479-09**

Cilia Forceps

9 cm





**FISKER**  
INSTRUMENTS

## Surgical Instruments

### Splinter Forceps



#### Phaneuf

**FI-5-501-21**

Hysterectomy Forceps  
20.5 cm



#### Wertheim-Cullen

**FI-5-502-21**

Vaginal Clamp  
21 cm

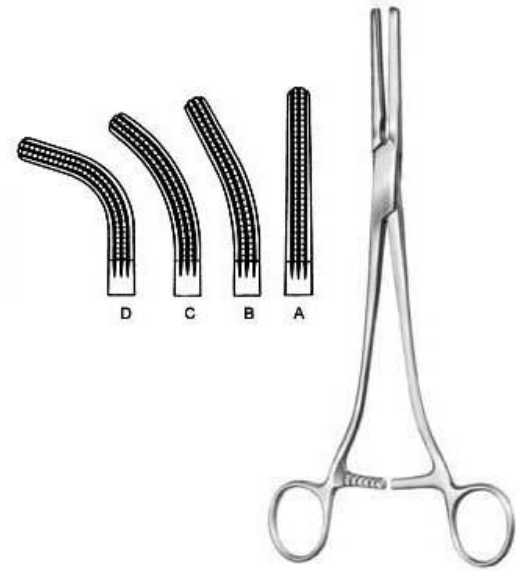

#### Rogers

**FI-5-503-10**

Hysterectomy Forceps  
21.5 cm Fig. 1, 21 cm Fig. 2, 20.5 cm Fig. 3, 20 cm Fig. 4



#### Moynihan

**FI-5-504-23**

Hysterectomy Forceps  
23 cm



#### Moynihan

**FI-5-505-24**

Hysterectomy Forceps  
23.5 cm



#### Wertheim

**FI-5-506-25**

Hysterectomy Forceps  
26 cm



**FISKER**  
INSTRUMENTS

## Surgical Instruments

### Splinter Forceps

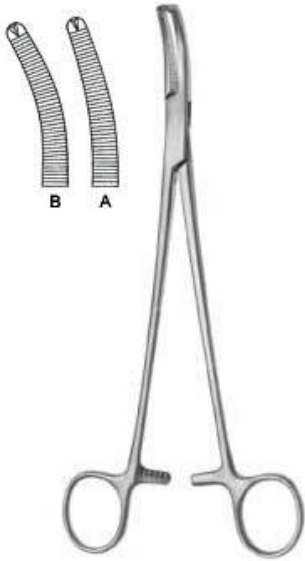

#### Wertheim

**FI-5-507-22**

Hysterectomy Forceps

22.5 cm



#### Mikulicz, Baby

**FI-5-508-14**

Peritoneum Forceps

14.5 cm



#### Mikulicz

**FI-5-509-18**

Peritoneum Forceps

20.5 cm



#### Mikulicz

**FI-5-510-20**

Peritoneum Forceps

18.5 cm



#### Mikulicz

**FI-5-511-20**

Peritoneum Forceps

20cm



#### Mikulicz

**FI-5-512-21**

Peritoneum Forceps

20.5 cm



**FISKER**  
INSTRUMENTS



**Faure**

**FI-5-513-20**

Peritoneum Forceps

21 cm



**FISKER**  
INSTRUMENTS

## Surgical Instruments

### Haemostatic Forceps

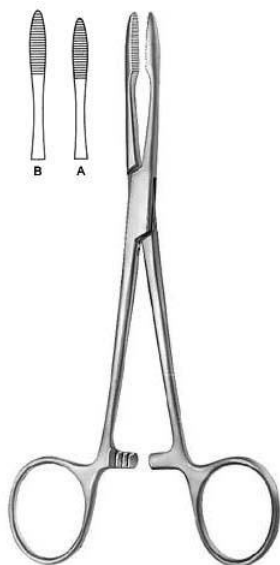

**Pean**

**FI-5-601-14**

Haemostatic Forceps  
14.5 cm , 16 cm

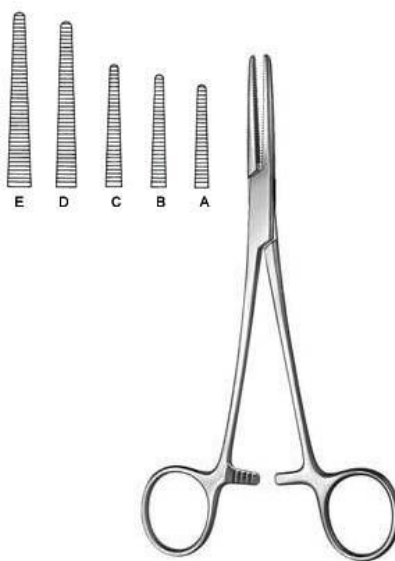

**Spencer-Wells**

**FI-5-602-13**

Haemostatic Forceps  
13 cm , 14 cm, 15.5 cm, 18.5 cm , 20 cm

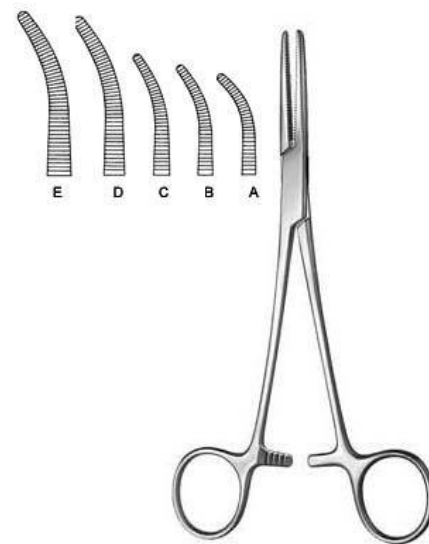

**Spencer-Wells**

**FI-5-603-13**

Haemostatic Forceps  
13 cm , 14 cm, 15 cm, 18 cm, 20 cm



**Chaput**

**FI-5-604-13**

Haemostatic Forceps  
12.5 cm



**Tuffier**

**FI-5-605-13**

Haemostatic Forceps  
12.5 cm

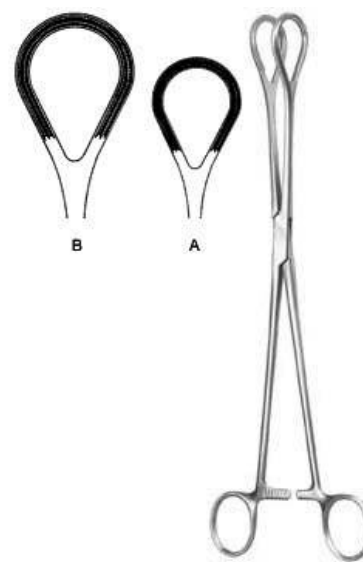

**Grasping Forceps**

**FI-5-606-25**

Organ Grasping Forceps



**FISKER**  
INSTRUMENTS

## Surgical Instruments

### Haemostatic Forceps



#### Collin

**FI-5-607-14**

Organ Grasping Forceps  
12.5 cm, 21 cm



#### Collin

**FI-5-608-17**

Tumor Grasping Forceps  
17 cm



#### Pennington

**FI-5-609-15**

Haemostatic Forceps  
15.5 cm



#### Pratt

**FI-5-610-15**

Haemostatic Forceps  
15 cm



#### Martel-Rees

**FI-5-611-14**

Face-lift Forceps  
13.5 cm



#### Ligature Forceps

**FI-5-612-12**

Ligature Forceps



**FISKER**  
INSTRUMENTS

# Surgical Instruments

## Haemostatic Forceps



### Mixer-Baby

**FI-5-613-01**

Dissecting and Ligature Forceps  
13 cm , 13.5 cm

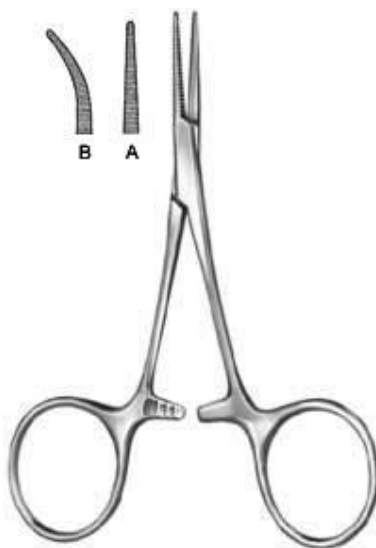

### Hartmann

**FI-5-614-10**

Haemostatic Forceps  
9.5 cm, 10 cm



### Ligature Forceps

**FI-5-615-12**

Ligature Forceps

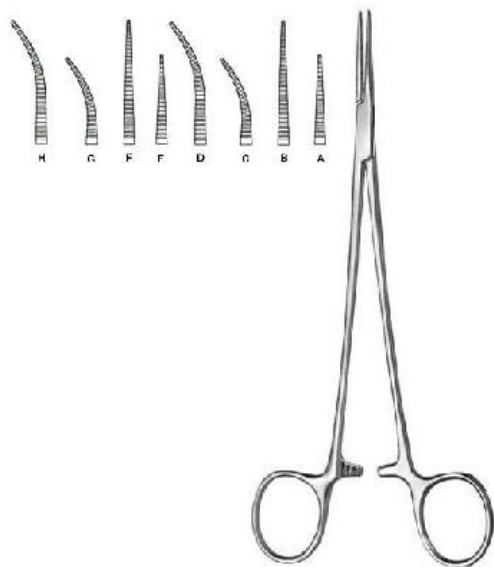

### Halsted-Mosquito

**FI-5-616-18**

Haemostatic Forceps  
12.5 cm, 14 cm, 14.5 cm

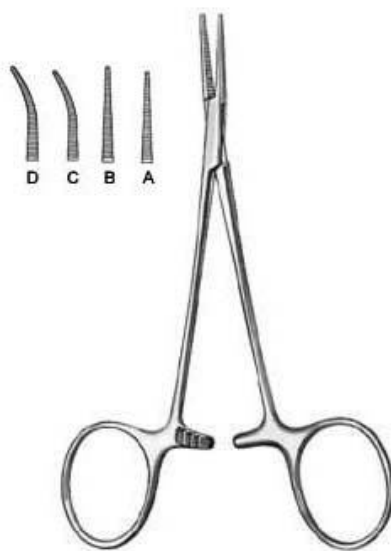

### Mikro-Mosquito

**FI-5-617-10**

Haemostatic Forceps  
9.5 cm, 10 cm , 11.5 cm, 12 cm



### Providence-Hospital

**FI-5-618-14**

Haemostatic Forceps  
14 cm



**FISKER**  
INSTRUMENTS

## Surgical Instruments

### Haemostatic Forceps



#### Leriche

**FI-5-619-15**

Haemostatic Forceps  
15 cm, 15.5 cm

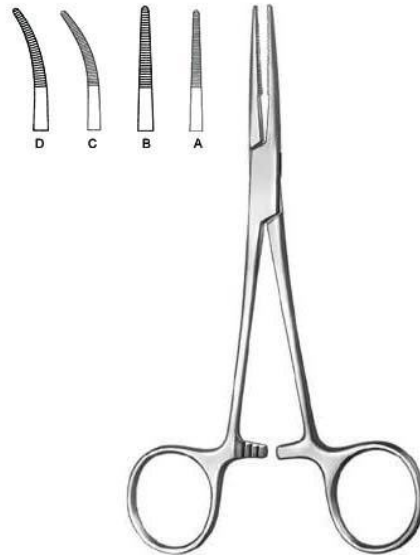

#### Kelly

**FI-5-620-14**

Haemostatic Forceps  
14 cm, 14.5 cm

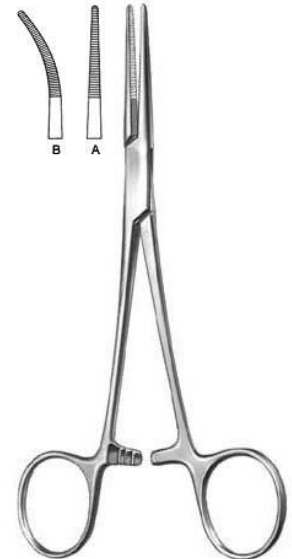

#### Kelly-Rankin

**FI-5-621-16**

Haemostatic Forceps  
15.5 cm, 16 cm



#### Overholt-Baby

**FI-5-622-14**

Dissecting and Ligature Forceps  
14 cm, 14.5 cm

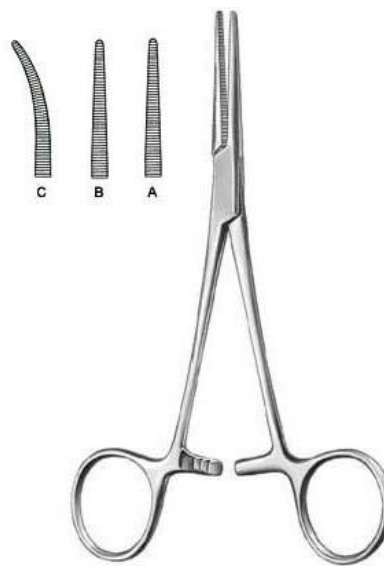

#### Crile

**FI-5-623-14**

Haemostatic Forceps  
14 cm, 14.5 cm



#### Crile-Rankin

**FI-5-624-16**

Haemostatic Forceps  
16 cm, 16.5 cm



**FISKER**  
INSTRUMENTS

## Surgical Instruments

### Haemostatic Forceps

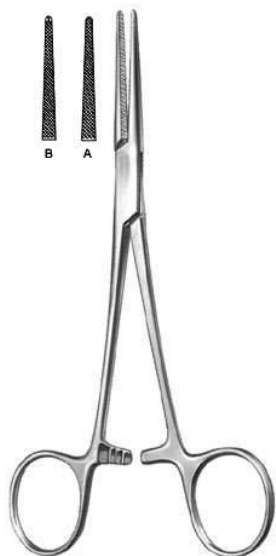

#### Lovelace

FI-5-625-15

Haemostatic Forceps

16 cm



#### Dandy-Mosquito

FI-5-626-12

Haemostatic Forceps

12 cm

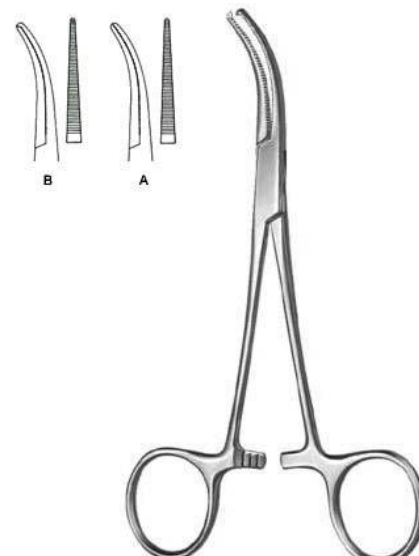

#### Dandy

FI-5-627-14

Haemostatic Forceps

14 cm, 14.5 cm



#### Schmidt

FI-5-628-18

Dissecting and Ligature Forceps

18.5 cm, 19 cm



#### Adson

FI-5-629-18

Dissecting and Ligature Forceps

18.5 cm, 19 cm



#### Martin-Fuchsig

FI-5-630-20

Dissecting and Ligature Forceps

20.5 cm





**FISKER**  
INSTRUMENTS

## Surgical Instruments

### Haemostatic Forceps

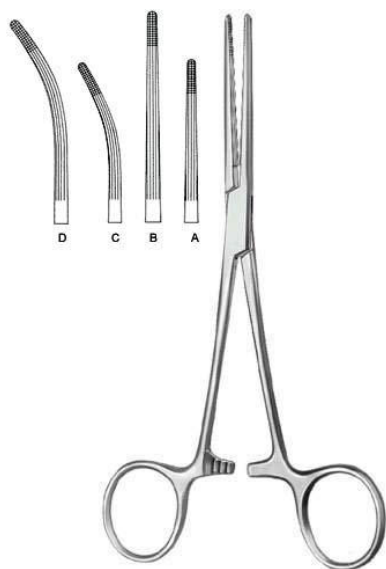

#### Rochester-Carmalt

**FI-5-631-16**

Haemostatic Forceps

16.5 cm, 17 cm, 20 cm, 20.5 cm

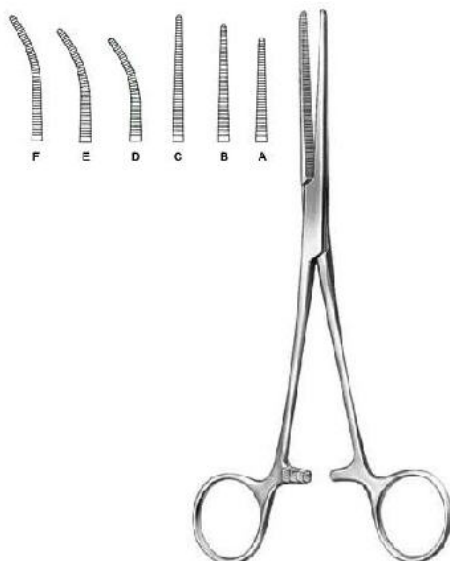

#### Pean

**FI-5-632-13**

Haemostatic Forceps

13 cm, 13.5 cm, 14 cm, 14.5 cm, 16.5 cm, 17 cm

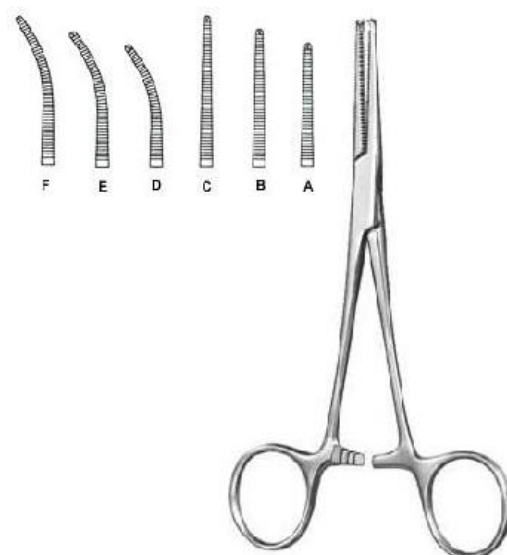

#### Kocher-Nippon

**FI-5-633-14**

Haemostatic Forceps

14.5 cm, 16 cm, 16.5 cm, 18 cm, 18 cm

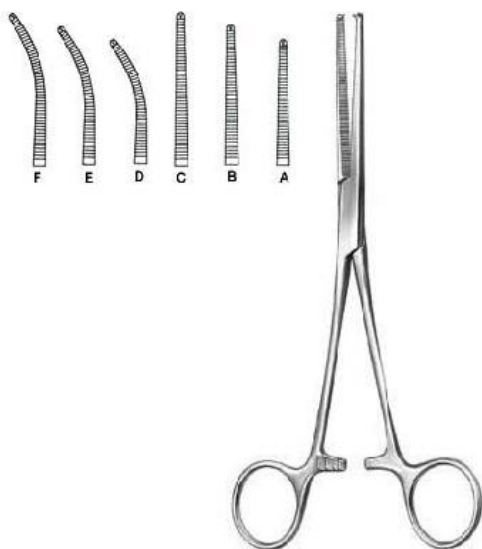

#### Kocher

**FI-5-635-13**

Haemostatic Forceps

13 cm, 14 cm, 16 cm

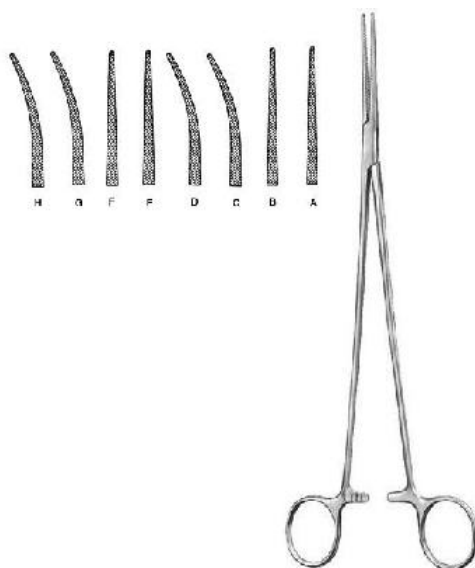

#### Bengolea

**FI-5-636-20**

Haemostatic Forceps

21 cm, 21.5 cm, 26 cm

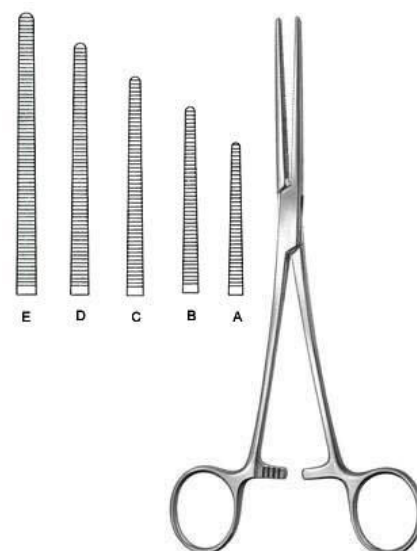

#### Pean (Rochester)

**FI-5-637-14**

Haemostatic Forceps

14 cm, 14.5 cm, 16 cm, 16.5 cm, 18.5 cm, 20.5 cm, 22.5 cm, 24.5 cm, 26 cm, 30.5 cm



**FISKER**  
INSTRUMENTS

## Surgical Instruments

### Haemostatic Forceps

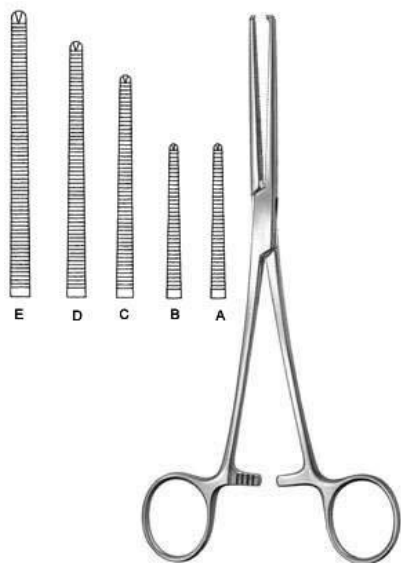

#### Kocher (Ochsner)

**FI-5-638-14**

Haemostatic Forceps

14.5 cm , 16.5 cm, 18.5 cm , 20.5 cm, 22.5 cm,  
24.5 cm, 26 cm, 30.5 cm

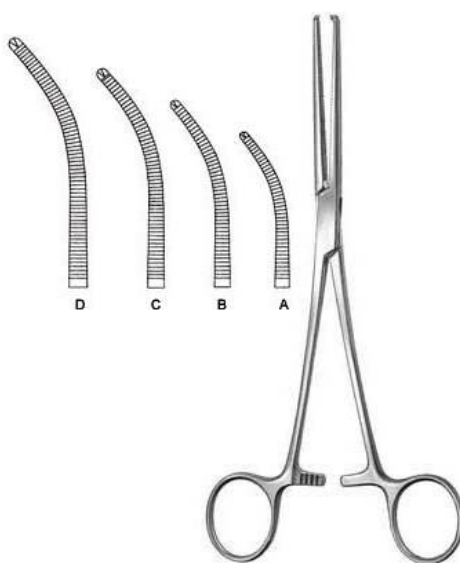

#### Kocher (Ochsner)

**FI-5-639-14**

Haemostatic Forceps

14 cm, 16 cm, 18 cm, 20 cm, 22 cm, 24 cm , 25.5  
cm, 30 cm

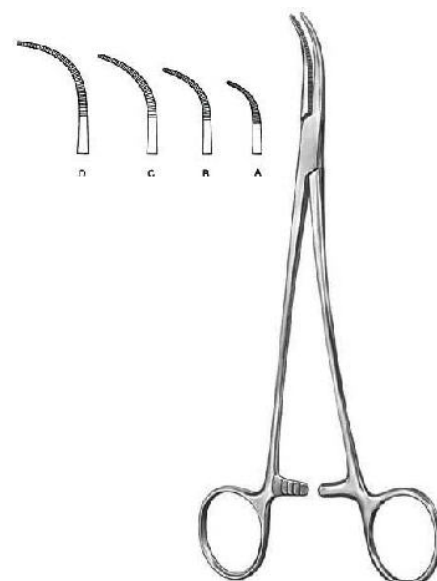

#### Overholt-Martin

**FI-5-640-01**

Dissecting and Ligature Forceps

18.5 cm Fig. 1 , 20.5 cm Fig. 2, 21 cm Fig. 3, 21.5  
cm Fig. 4, 24.5 cm Fig. 5



#### Mixer-Baby

**FI-5-641-18**

Dissecting and Ligature Forceps

18.5 cm



#### Adson-Baby

**FI-5-642-14**

Dissecting and Ligature Forceps

14.5 cm , 18 cm

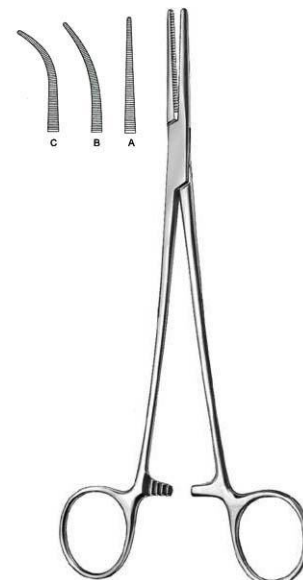

#### Heiss

**FI-5-643-20**

Dissecting and Ligature Forceps

20 cm, 20.5 cm, 21 cm



**Overholt-Mixter**

**FI-5-644-21**

Dissecting and Ligature Forceps  
21.5 cm

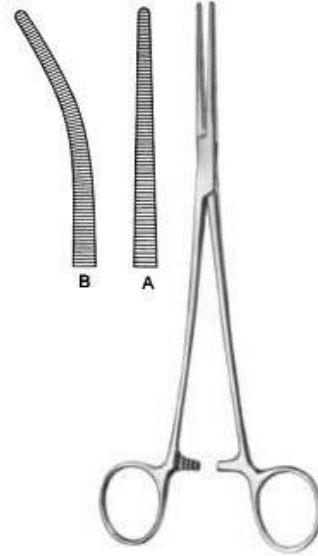

**Roberts**

**FI-5-645-22**

Dissecting and Ligature Forceps  
21.5 cm, 22.5 cm

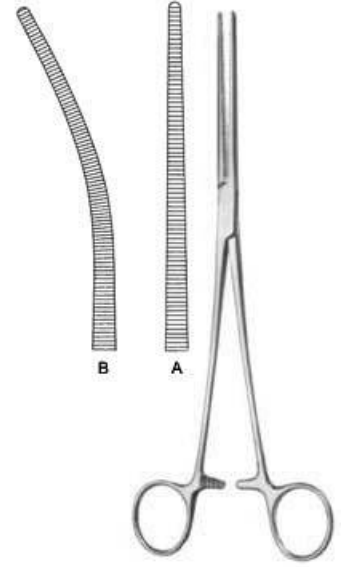

**Sarot**

**FI-5-646-24**

Dissecting and Ligature Forceps  
24.5 cm, 25 cm

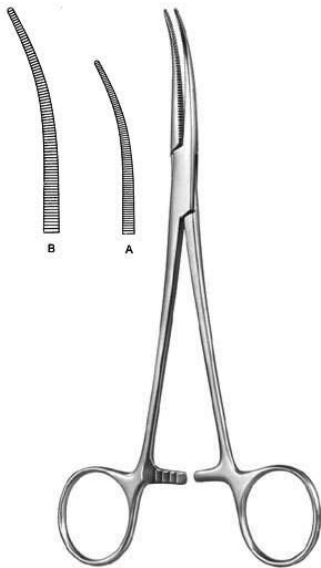

**Crafoord**

**FI-647-18**

Dissecting and Ligature Forceps  
18 cm, 24.5 cm

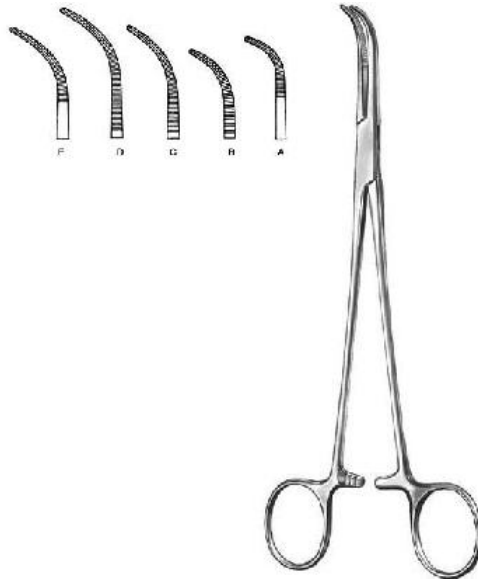

**Overholt-Geissendorfer**

**FI-5-648-01**

Dissecting and Ligature Forceps  
20.5 cm Fig. 1, 20 cm Fig. 2, 21.5 cm Fig. 3, 22 cm  
Fig. 4, 21.5 cm Fig. 5, 22 cm Fig. 6, 27 cm Fig. 1,  
26.5 cm Fig. 2, 27.5 cm Fig. 3, 28 cm Fig. 4

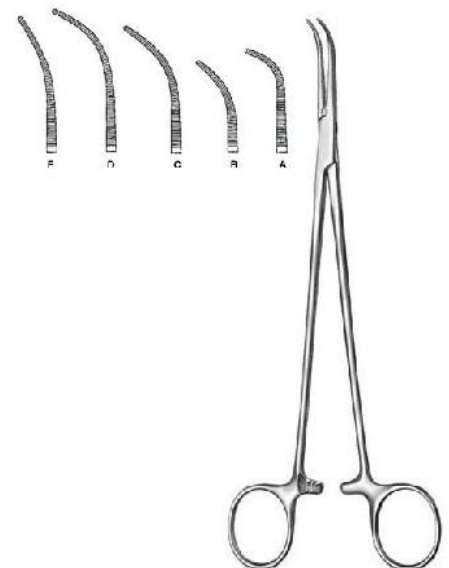

**Overholt-Fino**

**FI-5-649-00**

Dissecting and Ligature Forceps  
21 cm, 21.5 cm, 22 cm, 22.5 cm, 23 cm



**FISKER**  
INSTRUMENTS

## Surgical Instruments

### Haemostatic Forceps

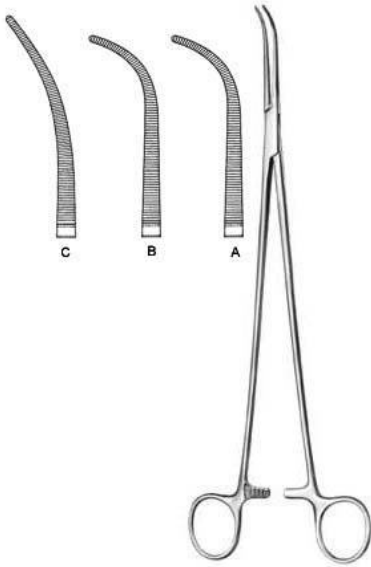

**Overholt**  
**FI-5-650-00**

Dissecting and Ligature Forceps  
29.5 cm, 30 cm



**Overholt-Mini**  
**FI-5-651-01**

Dissecting and Ligature Forceps  
15 cm, 20 cm

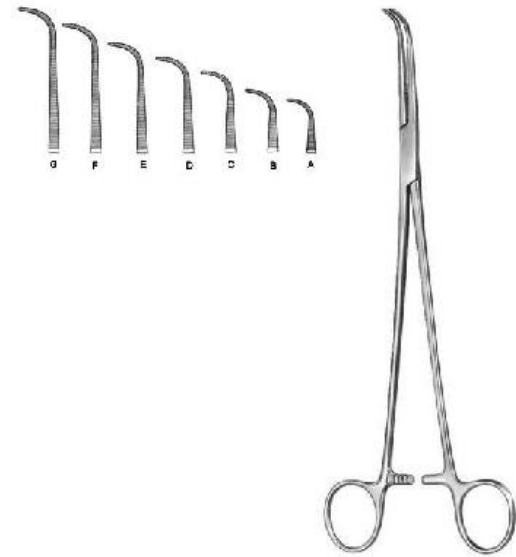

**Gemini**  
**FI-5-652-13**

Dissecting and Ligature Forceps  
13 cm, 16 cm, 18 cm, 21 cm, 23 cm, 25 cm, 28 cm

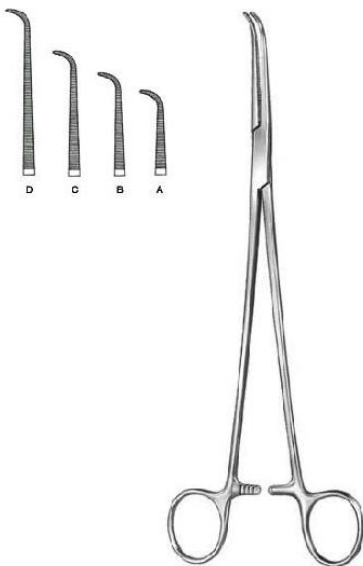

**Mini-Gemini**  
**FI-5-653-18**

Dissecting and Ligature Forceps  
18 cm, 22.5 cm, 25 cm, 28.5 cm

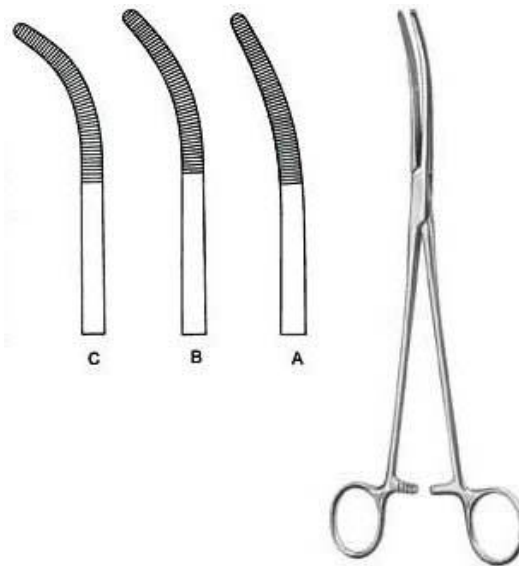

**Rumel**

**FI-5-654-01**

Dissecting and Ligature Forceps  
24 cm Fig. 1, 23.5 cm Fig. 2, 23 cm Fig. 3, 24 cm Fig. 4,  
23.5 cm Fig. 5

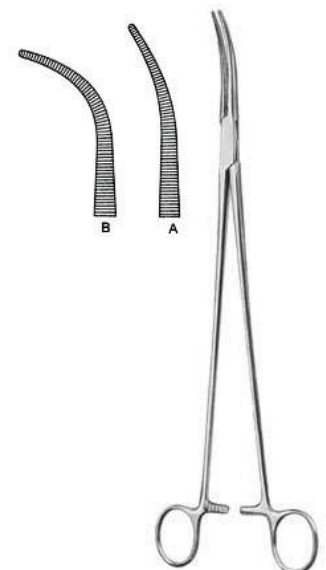

**Zenker**

**FI-5-655-01**

Dissecting and Ligature Forceps  
28.5 cm, 29.5 cm



**FISKER**  
INSTRUMENTS

## Surgical Instruments

### Haemostatic Forceps



#### Mixer-Baby

**FI-5-656-14**

Dissecting and Ligature Forceps  
13.5 cm

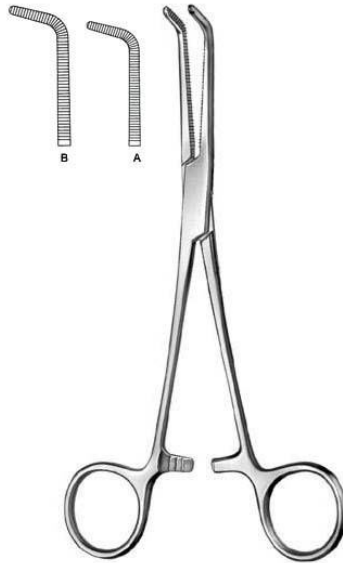

#### Mixer

**FI-5-657-15**

Dissecting and Ligature Forceps  
16 cm, 18 cm



#### Mixer-O Shaugnessy

**FI-5-658-19**

Dissecting and Ligature Forceps  
18 cm



#### Mixer

**FI-5-659-22**

Dissecting and Ligature Forceps  
22.5 cm



#### Mixer

**FI-5-660-23**

Dissecting and Ligature Forceps  
23 cm



#### Wickstrom

**FI-5-661-21**

Dissecting and Ligature Forceps  
21 cm, 24.5 cm



**FISKER**  
INSTRUMENTS

## Surgical Instruments

### Haemostatic Forceps

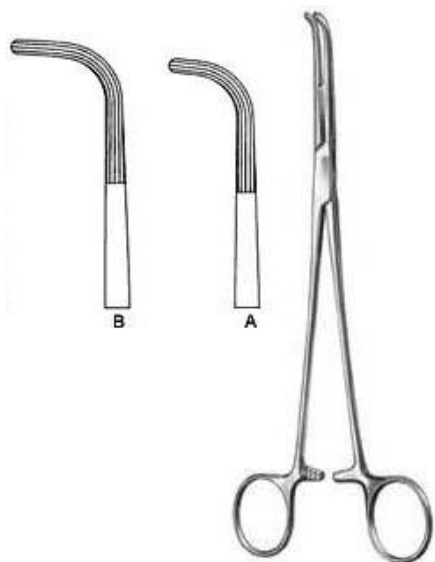

#### Mixer

**FI-5-662-22**

Dissecting and Ligature Forceps  
22.5 cm, 26 cm, 28 cm



#### Mc Quigg-Mixer

**FI-5-663-22**

Dissecting and Ligature Forceps  
23.5 cm



#### Lower

**FI-5-664-18**

Dissecting and Ligature Forceps  
18.5 cm

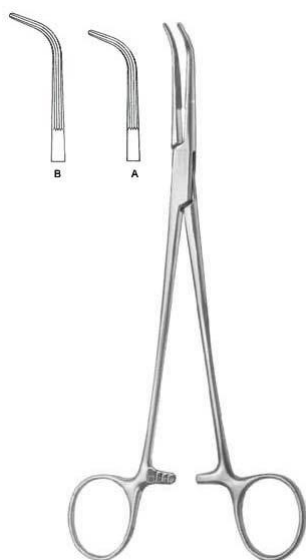

#### Lahey

**FI-5-665-19**

Bile Duct Clamp  
19.5 cm, 22.5 cm



#### Finochietto

**FI-5-666-24**

Dissecting and Ligature Forceps  
24 cm



#### Uro-Tangential

**FI-5-667-01**

Tangential Forceps  
25 cm, 27 cm



**FISKER**  
INSTRUMENTS

# Surgical Instruments

## Haemostatic Forceps

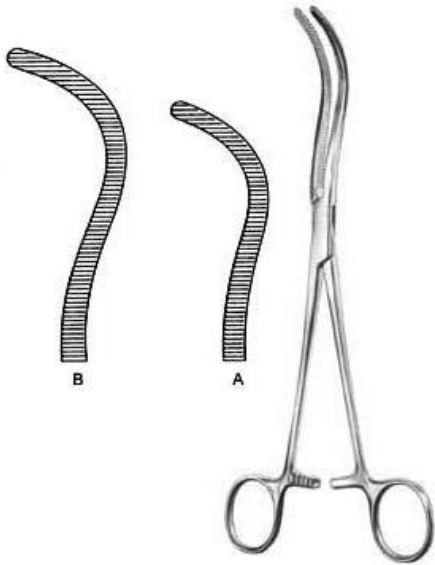

**Guyon**

**FI-5-668-20**

Kidney Pedicle Clamp  
23 cm , 24 cm



**Guyon**

**FI-5-669-23**

Kidney Pedicle Clamp  
19.5 cm , 21.5 cm, 24 cm



**Desjardins**

**FI-5-670-21**

Bile Duct Clamp  
21 cm

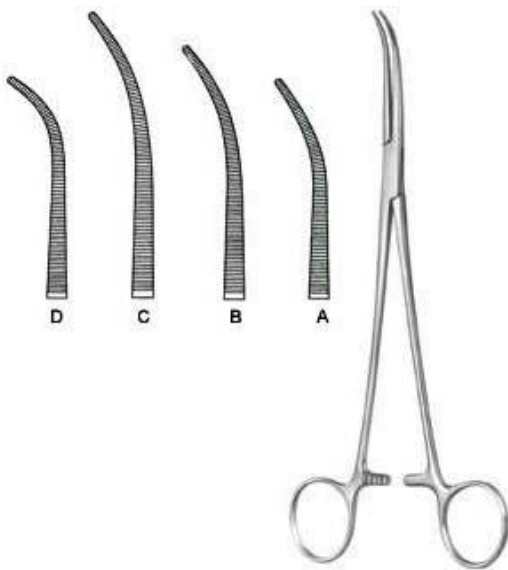

**Kelly**

**FI-5-671-19**

Dissecting and Ligature Forceps

19.5 cm Fig. 1 , 22.5 cm Fig. 1 , 24.5 cm Fig. 1 , 19 cm Fig. 2 , 22 cm Fig. 2 , 24 cm Fig. 2 , 18.5 cm Fig. 3 , 23.5 cm Fig. 3 , 21.5 cm Fig. 3



**Lawrence**

**FI-5-672-28**

Dissecting and Ligature Forceps  
28 cm



**Meeker**

**FI-5-673-28**

Dissecting and Ligature Forceps  
28 cm



**FISKER**  
INSTRUMENTS

## Surgical Instruments

Haemostatic Forceps



### **Negus**

**FI-5-674-19**

Haemostatic Forceps

19.5 cm Fig. 1 , 20 cm Fig. 2





**FISKER**  
INSTRUMENTS

## Surgical Instruments

### Towel & Tubing Clamps



**Schaedel**  
**FI-5-701-09**

Towel Clamp sharp  
9 cm



**Jones**  
**FI-5-702-05**

Towel Clamp sharp  
5.5 cm, 8.5 cm



**Jones-Martin**  
**FI-5-703-09**

Towel Clamp sharp  
8.5 cm



**Backhaus**  
**FI-5-705-11**

Towel Clamp  
11.5 cm



**Backhaus**  
**FI-5-706-08**

Towel Clamp  
9 cm, 11.5 cm, 13 cm, 16 cm



**Peers-Bertram Modif.**  
**FI-5-707-15**

Towel Clamp wide jaw for tube fixation  
15.5 cm



**FISKER**  
INSTRUMENTS

## Surgical Instruments

### Towel & Tubing Clamps



**R?Der**

**FI-5-708-13**

Towel Clamp  
13.5 cm

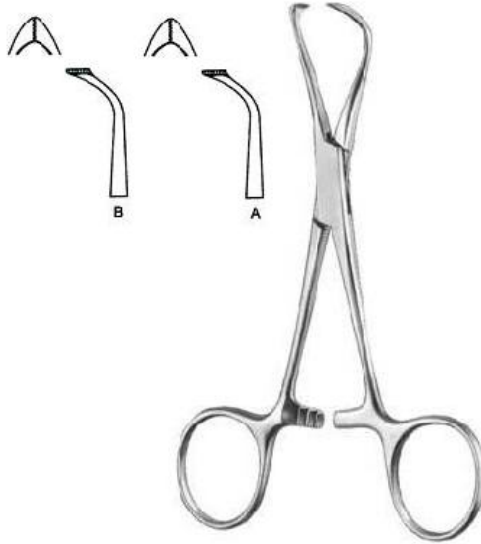

**Lorna**

**FI-5-709-10**

Towel Clamp fine serrated, wide jaw  
9.5 cm, 13 cm



**Bernhard**

**FI-5-710-16**

Towel Clamp  
16.5 cm

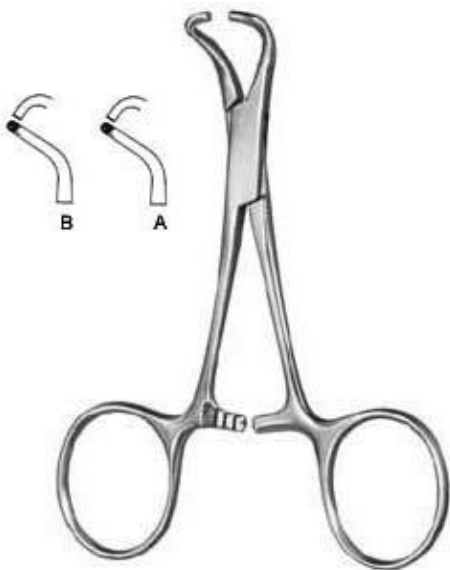

**Tohoku**

**FI-5-711-10**

Towel Clamp  
10.5 cm blunt, 13.5 cm blunt, 14.5 cm

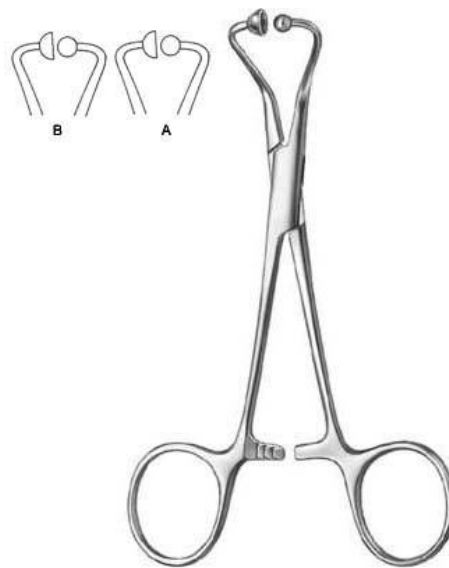

**Towel Clamp For Paper Clothes**

**FI-5-712-11**

Towel Clamp for paper clothes  
11.5 cm, 14 cm



**Lane**

**FI-5-713-20**

Lane  
19.5 cm



**FISKER**  
INSTRUMENTS

## Surgical Instruments

Towel & Tubing Clamps



**Tube Holder For Fixation Of Six Tubes**

**FI-5-714-06**

Tube Holder for fixation of six tubes



**Tubing Clamp Extra Long Ratchet**

**FI-5-715-14**

Tubing Clamp extra long ratchet

14 cm



**Tubing Clamp**

**FI-5-716-16**

Tubing Clamp

16.5 cm

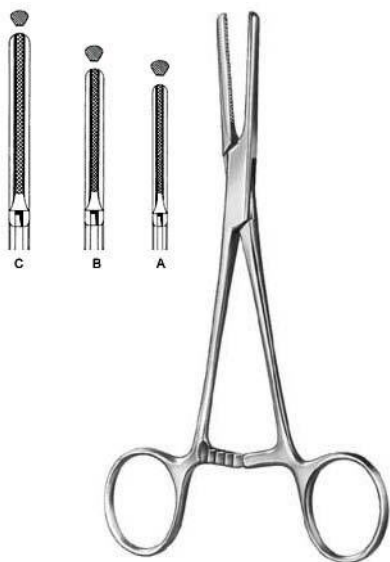

**Tubing Clamp**

**FI-5-717-15**

Tubing Clamp

15.5 cm, 19 cm, 20.5 cm

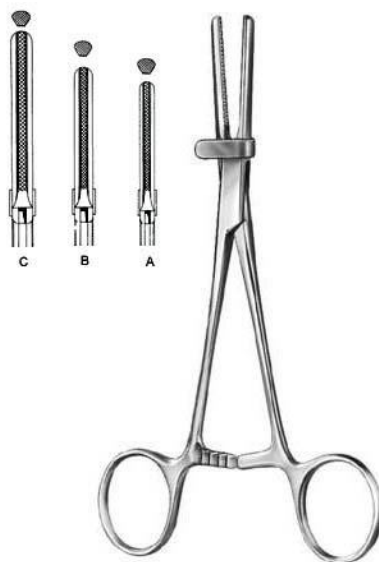

**Tubing Clamp With Safety Guard**

**FI-5-718-15**

Tubing Clamp with safety guard

15.5 cm, 19 cm, 20.5 cm



**Backhaus**

**FI-5-704-11**

Towel Clamp

11.5 cm, 13 cm



**FISKER**  
INSTRUMENTS

## Surgical Instruments

Dressing & Sponge Forceps

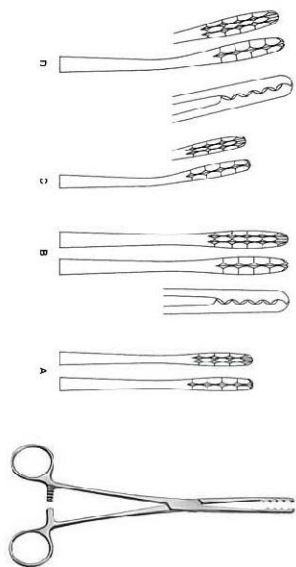

### Ulrich

**FI-5-801-22**

Dressing Forceps  
21.5 cm, 26.5 cm

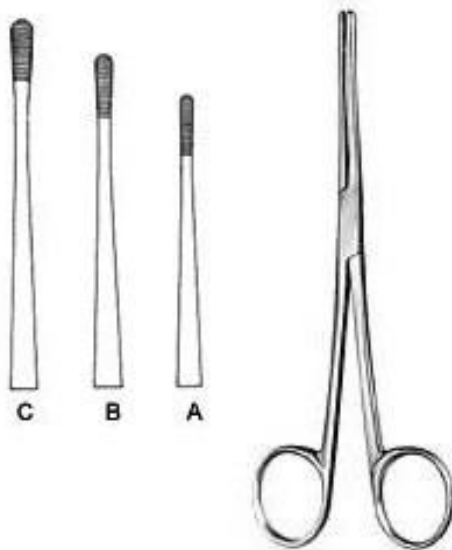

### Lister

**FI-5-802-13**

Sinus Forceps  
13 cm, 16 cm, 18 cm

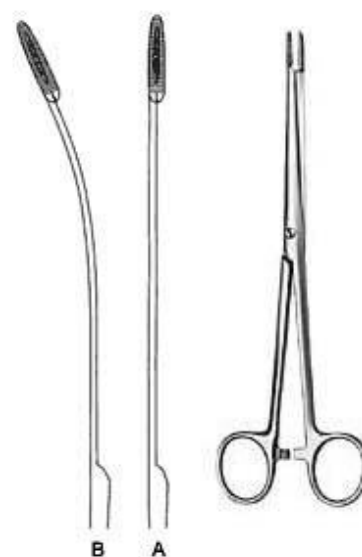

### Martin

**FI-5-803-17**

Dressing Forceps  
17.5 cm, 17 cm

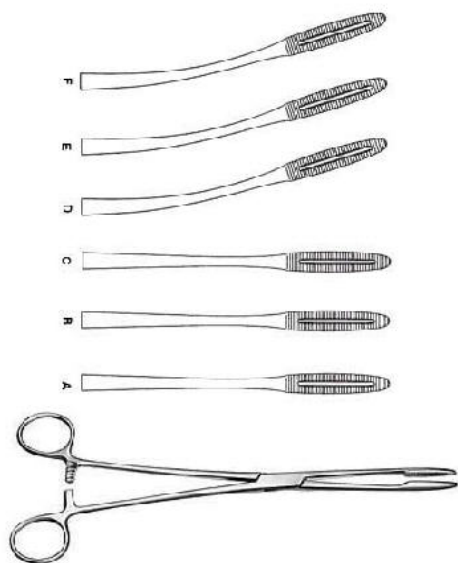

### Gross-Maier

**FI-5-804-20**

Dressing Forceps  
20.5 cm, 22 cm, 26.5 cm, 20 cm, 21.5 cm, 26 cm



### Tunneling Forceps

**FI-5-805-40**

Tunneling Forceps  
39.5 cm



### Collin

**FI-5-806-25**

Dressing Forceps  
25.5 cm



**FISKER**  
INSTRUMENTS

## Surgical Instruments

### Dressing & Sponge Forceps



#### **Cheron**

**FI-5-807-25**

Dressing Forceps  
23.5 cm



#### **Bozemann**

**FI-5-808-26**

Sponge Forceps  
26 cm

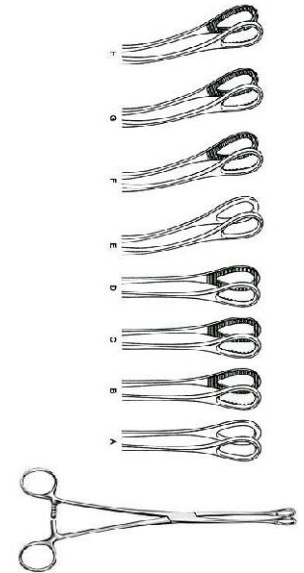

#### **Foerster**

**FI-5-809-25**

Sponge Forceps  
25 cm , 18 cm, 20.5 cm, 24.5 cm, 17.5 cm, 20 cm,  
24.5 cm

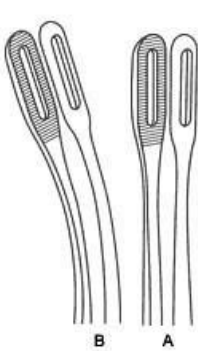

#### **Foerster**

**FI-5-810-25**

Sponge Forceps  
25 cm , 24.5 cm

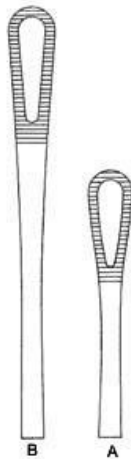

#### **Rampley**

**FI-5-811-18**

Sponge Forceps  
18.5 cm , 24.5 cm



**FISKER**  
INSTRUMENTS

## Surgical Instruments

Retractors



**Vickers**  
**FI-5-901-18**  
Skin Hooklet  
18.5 cm



**Vickers**  
**FI-5-902-01**  
Bone Hooklet  
17 cm



**Vickers**  
**FI-5-903-01**  
Tendon Hooklet  
17 cm



**Vickers**  
**FI-5-904-02**  
Hooklet  
16 cm

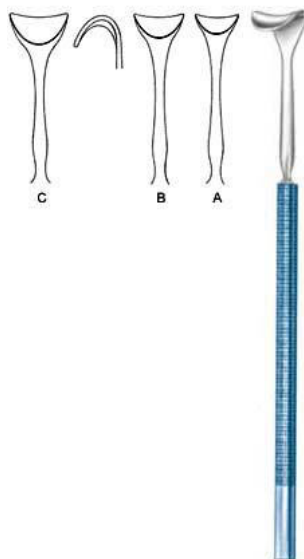

**Vickers**  
**FI-5-905-12**  
Saddle Hook  
14 cm



**Graefe**  
**FI-5-906-01**  
Micro Hooklet  
15 cm



**FISKER**  
INSTRUMENTS

# Surgical Instruments

## Retractors

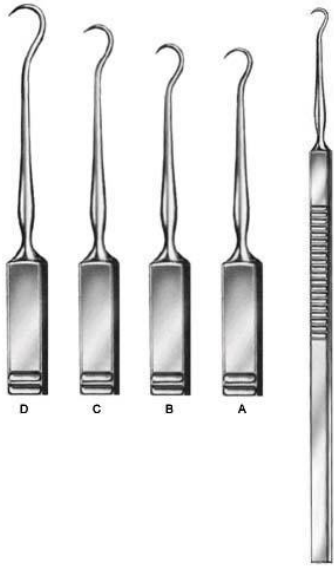

### Skin Hook

**FI-5-907-01**

Skin Hook

16 cm Fig. 1, 16 cm Fig. 2, 16 cm Fig. 3, 16 cm Fig. 4



### O Connor

**FI-5-908-16**

Skin Hook

16 cm

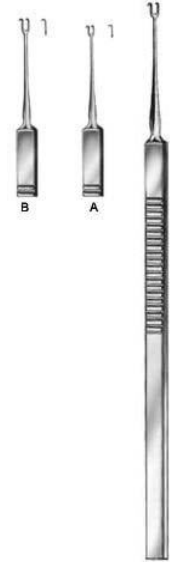

### Guthrie

**FI-5-909-01**

Skin Hook

15.5 cm

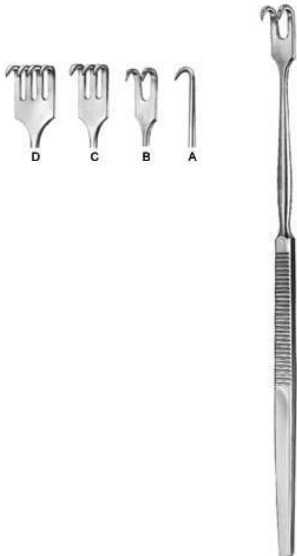

### Hooklet

**FI-5-910-01**

Hooklet

16.5 cm



### Hooklet

**FI-5-911-01**

Hooklet

16.5 cm



### Hooklet

**FI-5-912-02**

Hooklet

16 cm



**FISKER**  
INSTRUMENTS

# Surgical Instruments

## Retractors



### Hooklet

**FI-5-913-04**

Hooklet  
16.5 cm



### Vessel Hook

**FI-5-914-12**

Vessel Hook  
12 cm

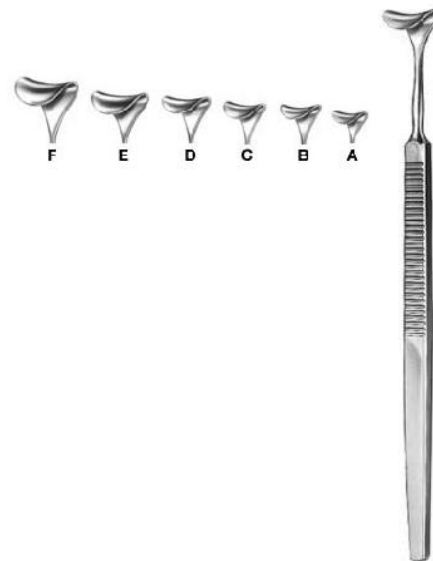

### Desmarres

**FI-5-915-08**

Saddle Hook  
16 cm 8 mm, 16 cm 10 mm, 16 cm 12 mm, 16 cm 14 mm, 16 cm 16 mm, 16 cm 18 mm

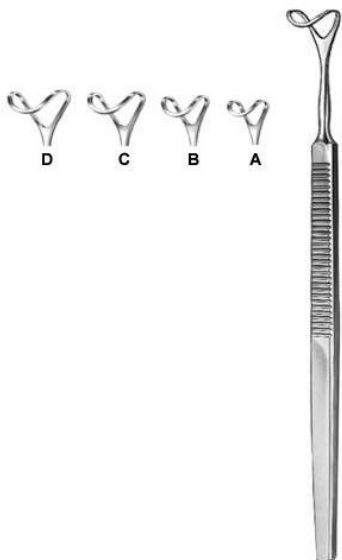

### Saddle Hook

**FI-5-916-12**

Saddle Hook  
16 cm 12 mm, 16 cm 14 mm, 16 cm 16 mm, 16 cm 18 mm

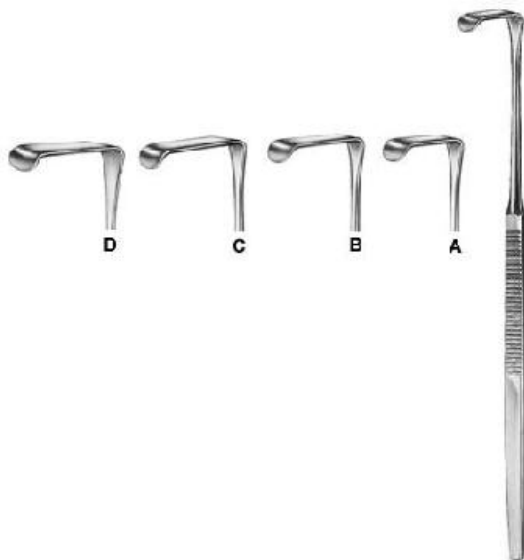

### Langenbeck-Mini

**FI-5-917-10**

Langenbeck-Mini  
16 cm



### Hooklet

**FI-5-918-16**

Hooklet  
16 cm 14 x 8





**FISKER**  
INSTRUMENTS

# Surgical Instruments

Retractors



**Hooklet**  
**FI-5-919-01**  
Hooklet  
16.5 cm



**Hooklet**  
**FI-5-920-01**  
Hooklet  
16.5 cm



**Meyerding**  
**FI-5-921-01**  
Hooklet  
17.5 cm Fig. 1, 17.5 cm Fig. 2, 17.5 cm Fig. 3, 17.5 cm Fig. 4, 17.5 cm Fig. 5, 17.5 cm Fig. 6



**Senn-Green**  
**FI-5-922-01**  
Hooklet  
15 cm Fig. 1, 15 cm Fig. 2



**Ragnell-Davis**  
**FI-5-923-14**  
Hooklet  
14 cm

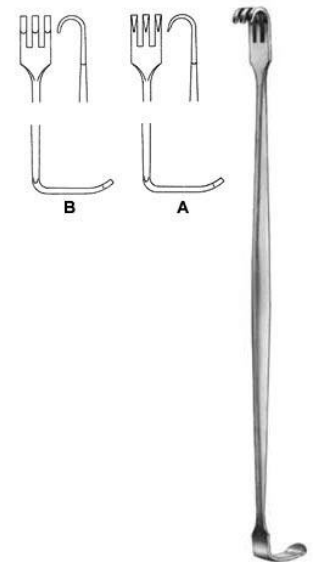

**Senn-Miller**  
**FI-5-924-16**  
Hooklet  
16 cm



**FISKER**  
INSTRUMENTS

## Surgical Instruments

Retractors



**Cushing**  
**FI-5-925-20**  
Cushing  
20.5 cm

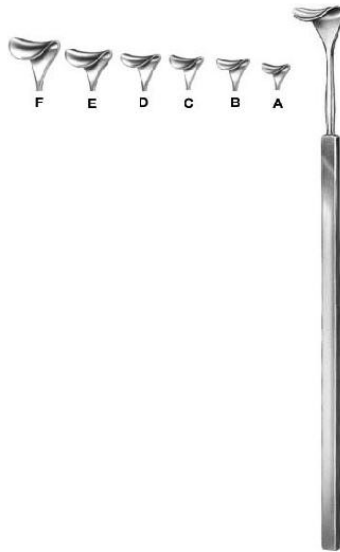

**Cushing**  
**FI-5-926-08**  
Saddle Hook  
20.5 cm 8 mm wide, 20.5 cm 10 mm wide, 20.5 cm 12 mm wide, 20.5 cm 14 mm wide, 20.5 cm 16 mm wide, 20.5 cm 18 mm wide

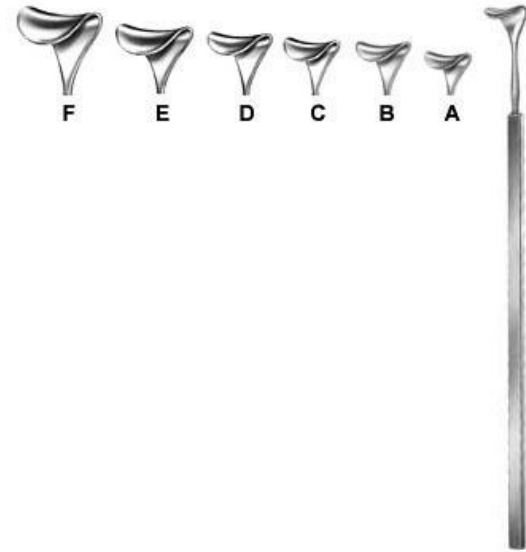

**Cushing**  
**FI-5-927-08**  
Saddle Hook 8 mm to 18 mm wide  
24 cm



**Brom**  
**FI-5-928-01**  
Vein Hook  
19.5 cm



**Strandell-Stillie**  
**FI-5-929-01**  
Strandell-Stillie  
19 cm Fig. 1, 19 cm Fig. 2

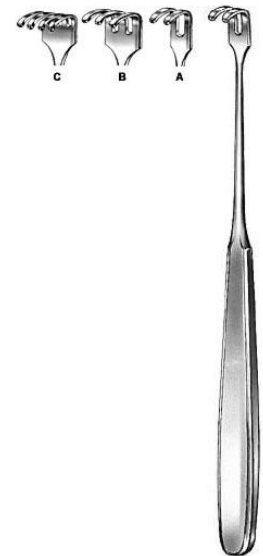

**Klapp**  
**FI-5-930-01**  
Retractor 12 x 6, 12 x 11, 15 x 11  
17.5 cm



**FISKER**  
INSTRUMENTS

# Surgical Instruments

## Retractors



**Hooklet**  
**FI-5-931-04**  
Hooklet  
16.5 cm

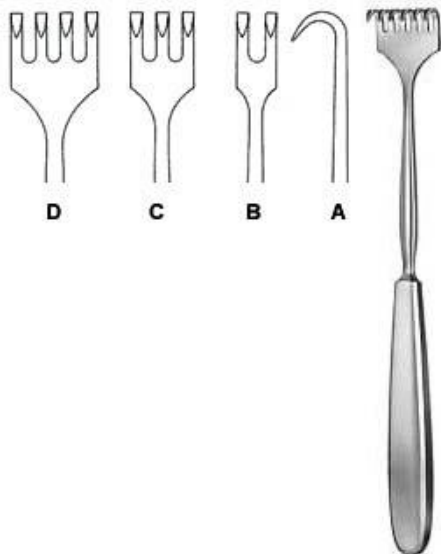

**Volkmann**  
**FI-5-932-01**  
Retractor  
21.5 cm

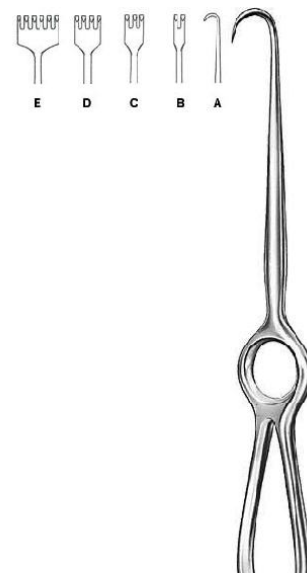

**Volkmann**  
**FI-5-933-01**  
Retractor  
22 cm, 21.5 cm

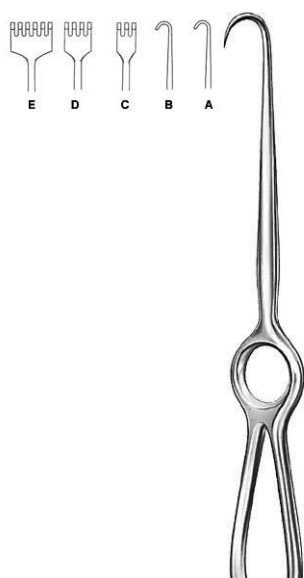

**Kocher**  
**FI-5-934-01**  
Retractor  
22 cm

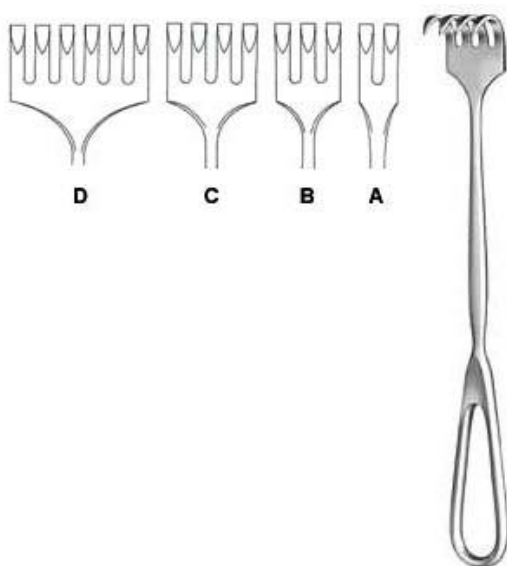

**Martin**  
**FI-5-935-02**  
Retractor  
22.5 cm

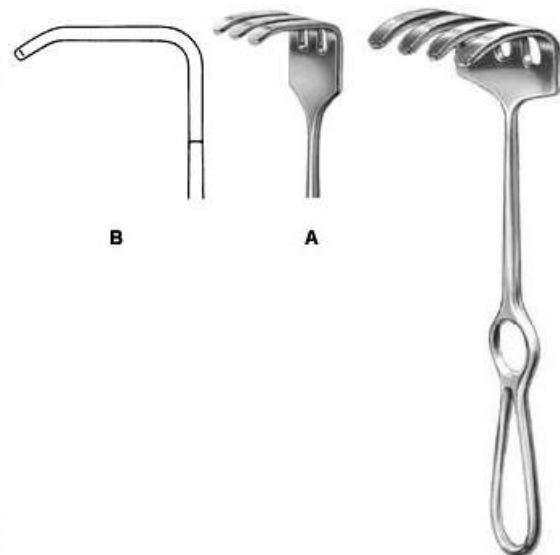

**Ollier**  
**FI-5-936-03**  
Retractor  
23 cm 36 x 30, 23 cm 36 x 60



**FISKER**  
INSTRUMENTS

# Surgical Instruments

## Retractors



**Wassmund**

**FI-5-937-02**

Retractor  
20.5 cm 33 x 21

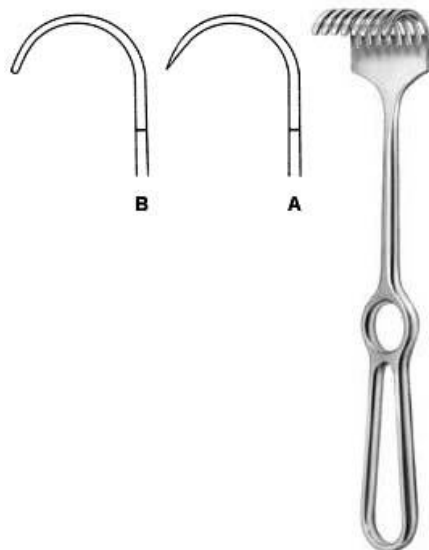

**Korte**

**FI-5-938-08**

Retractor  
24.5 cm 40 x 30

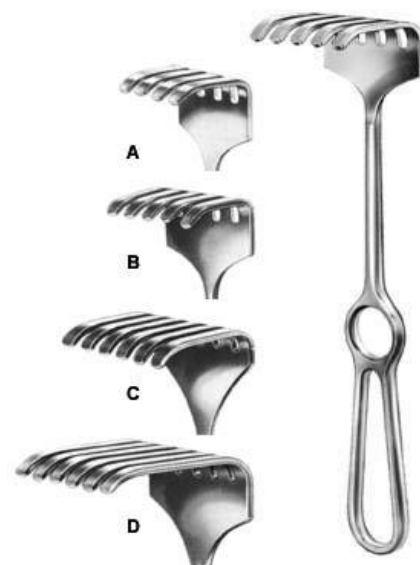

**Israel**

**FI-5-939-04**

Retractor  
25.5 cm

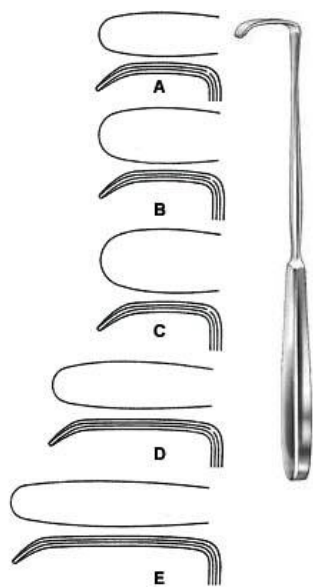

**Langenbeck**

**FI-5-940-01**

Retractor  
22.5 cm 30 x 11 mm, 22.5 cm 30 x 14 mm, 22.5 cm 30 x 16 mm, 22.5 cm 40 x 11 mm, 22.5 cm 50 x 11 mm

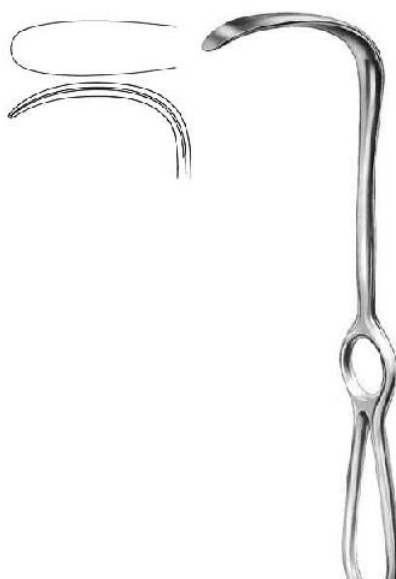

**Langenbeck**

**FI-5-942-21**

Retractor  
21 cm 65 x 20 mm

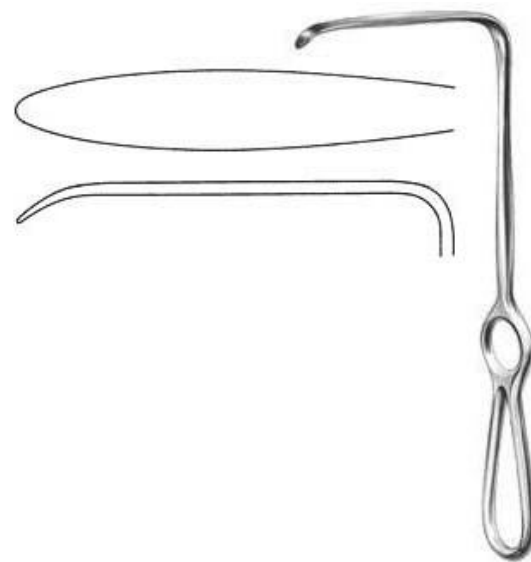

**Langenbeck**

**FI-5-943-21**

Retractor  
22.5 cm 85 x 15 mm



**FISKER**  
INSTRUMENTS

# Surgical Instruments

## Retractors



### Lahey

**FI-5-944-19**

Retractor

19.5 cm 36 x 19 mm



### Little

**FI-5-945-20**

Retractor

20 cm 13 x 15 mm

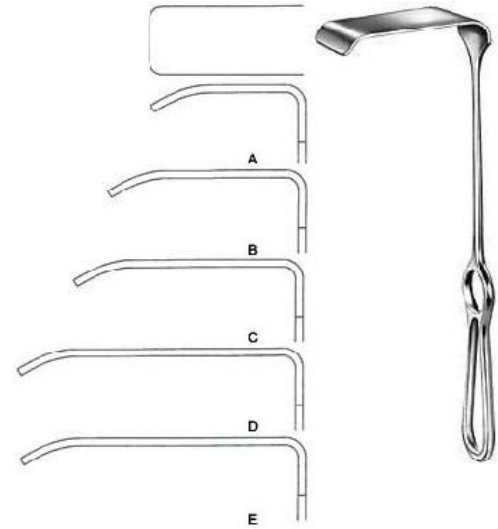

### Kocher

**FI-5-946-18**

Retractor

23 cm 43 x 18 mm, 23 cm 53 x 20 mm, 23 cm 63 x 25 mm, 23 cm 77 x 30 mm, 23 cm 78 x 40 mm

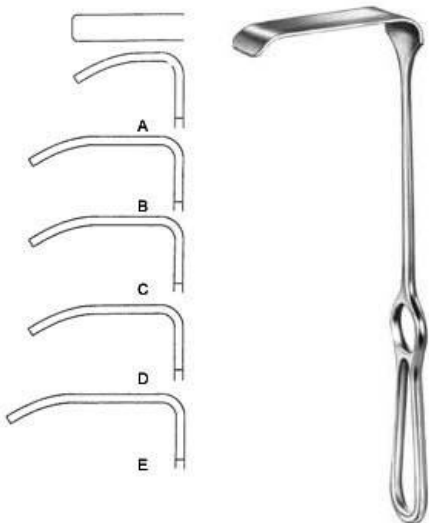

### Kocher-Langenbeck

**FI-5-947-01**

Retractor

21.5 cm 25 x 6 mm, 21.5 cm 35 x 8 mm, 21.5 cm 35 x 11 mm, 21.5 cm 35 x 15 mm, 21.5 cm 40 x 11 mm, 21.5 cm 55 x 11 mm, 21.5 cm 70 x 14 mm, 21.5 cm 80 x 12 mm

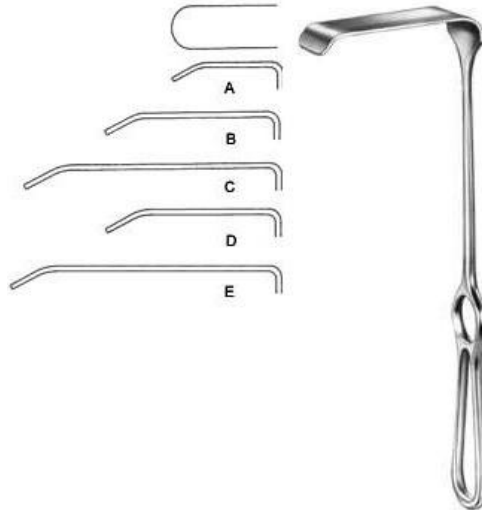

### Kocher-Langenbeck

**FI-5-948-01**

Retractor

21.5 cm 25 x 10 mm, 21.5 cm 40 x 13 mm, 21.5 cm 60 x 13 mm, 21.5 cm 40 x 18 mm, 21.5 cm 60 x 18 mm, 21.5 cm 85 x 18 mm, 21.5 cm 60 x 25 mm, 21.5 cm 85 x 25 mm

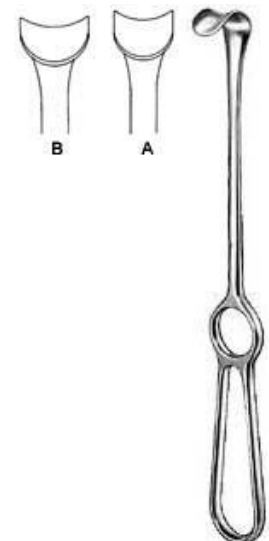

### Kocher

**FI-5-949-01**

Retractor

21.5 cm 22 x 12, 21.5 cm 24 x 14 mm



**FISKER**  
INSTRUMENTS

# Surgical Instruments

## Retractors

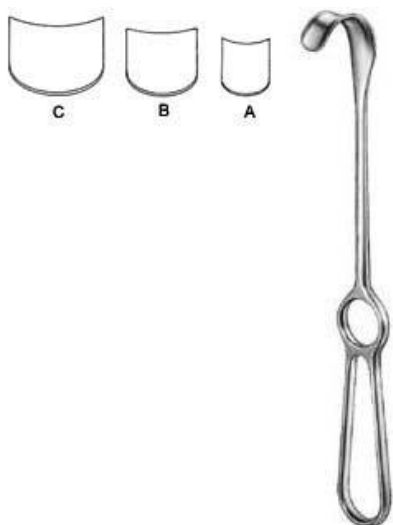

### Kocher

**FI-5-950-01**

Retractor

22 cm 42 x 10 mm, 22 cm 42 x 15 mm, 22 cm 43 x 20 mm

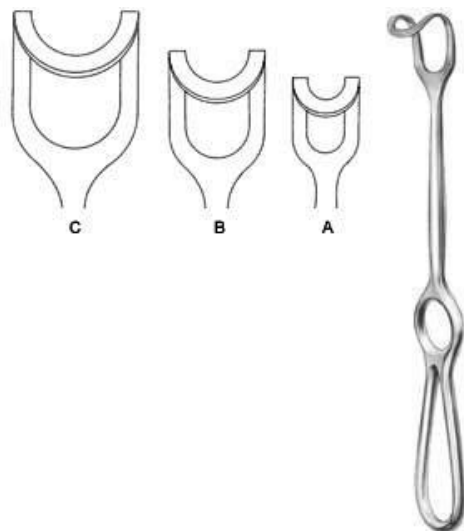

### Middeldorpf

**FI-5-951-01**

Retractor

21.5 cm 18 x 17 mm, 23 cm 25 x 22 mm, 24.5 cm 30 x 31 mm

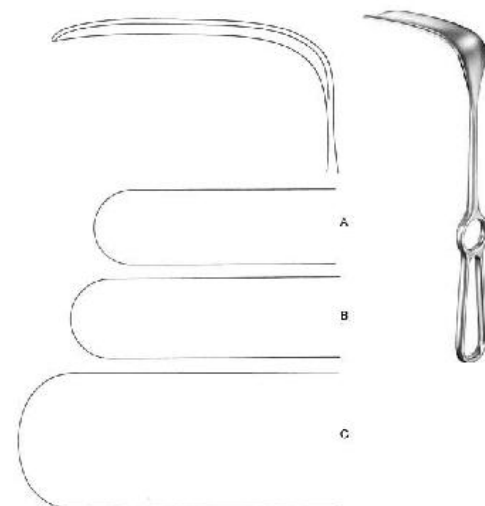

### Doyen-Stille

**FI-5-952-01**

Retractor

26 cm 97 x 29 mm, 26 cm 101 x 31 mm, 26 cm 127 x 52 mm



### Hosel

**FI-5-953-01**

Retractor

26 cm 63 x 21 mm, 26 cm 83 x 30 mm, 26 cm 103 x 30 mm, 26 cm 120 x 30 mm, 26 cm 140 x 30 mm, 26 cm 140 x 40 mm

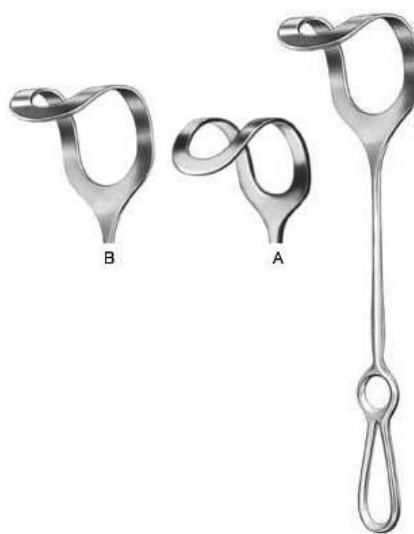

### Middeldorpf

**FI-5-954-01**

Retractor

27 cm 48 x 45 mm, 27 cm 52 x 50 mm, 27 cm 60 x 70 mm

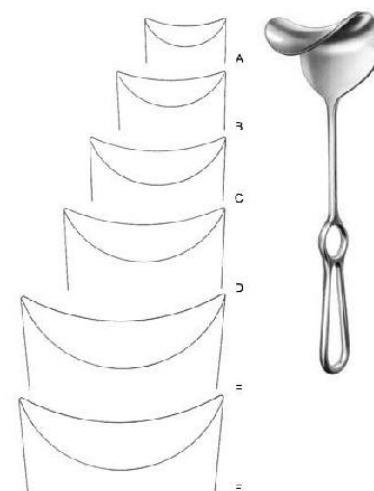

### Fritsch

**FI-5-955-00**

Retractor

23.5 cm 37 x 31 mm, 24 cm 38 x 40 mm, 25 cm 43 x 51 mm, 25 cm 49 x 61 mm, 25.5 cm 48 x 75 mm, 25.5 cm 65 x 85 mm



**FISKER**  
INSTRUMENTS

## Surgical Instruments

### Retractors



#### Doyen

FI-5-956-25

Retractor

24 cm 48 x 88 mm



#### Kocher

FI-5-957-22

Retractor

24 cm 73 x 25 mm



#### Kocher

FI-5-958-01

Retractor

25 cm 80 x 45 mm, 25 cm 80 x 55 mm, 25 cm 80 x 65 mm



#### Martin

FI-5-959-25

Retractor

26 cm 110 x 27 mm

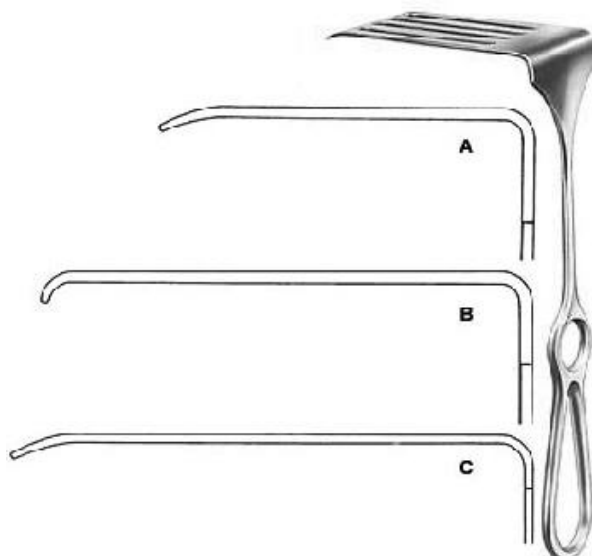

#### Coryllos

FI-5-960-01

Retractor

24 cm 85 x 22 mm, 24 cm 108 x 43 mm, 24 cm 119 x 65 mm



#### Davidson

FI-5-961-01

Retractor

19 cm 80 x 54 mm, 18.5 cm 80 x 95 mm



**FISKER**  
INSTRUMENTS

## Surgical Instruments

### Retractors

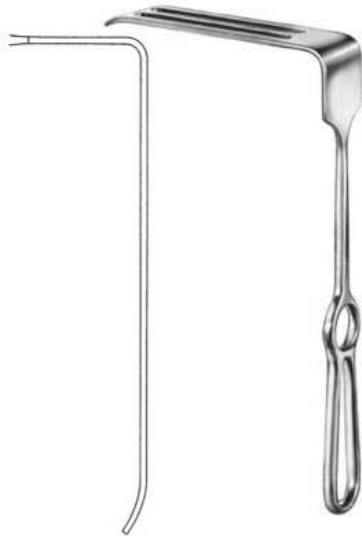

#### Sauerbruch

**FI-5-962-25**

Retractor

25.5 cm 127 x 38 mm

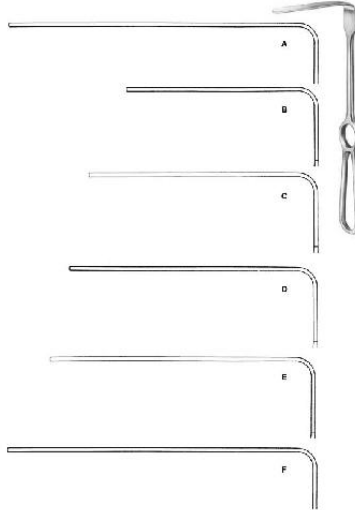

#### Brunner

**FI-5-963-08**

Retractor

25.5 cm 84 x 20 mm, 25.5 cm 104 x 25 mm, 25.5 cm 124 x 30 mm, 25.5 cm 130 x 30 mm, 25.5 cm 144 x 30 mm, 25.5 cm 160 x 30 mm, 25.5 cm 164 x 30 mm

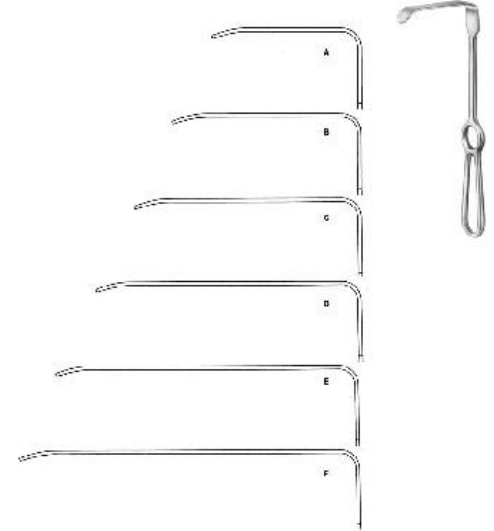

#### Brunner

**FI-5-964-08**

Retractor

25.5 cm 82 x 20 mm, 25.5 cm 102 x 20 mm, 25.5 cm 122 x 25 mm, 25.5 cm 140 x 25 mm, 25.5 cm 162 x 30 mm, 25.5 cm 182 x 30 mm

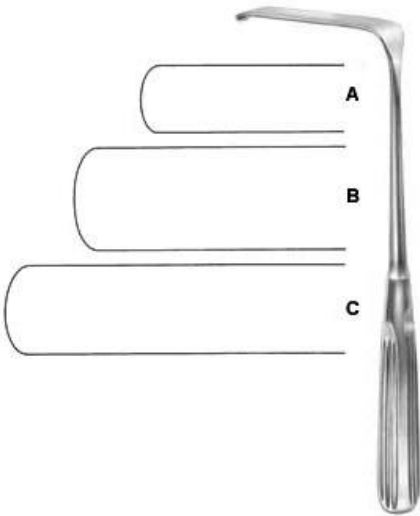

#### Sauerbruch

**FI-5-965-01**

Retractor

22.5 cm 50 x 15 mm, 22.5 cm 63 x 23 mm, 22.5 cm 80 x 20 mm



#### Deaver

**FI-5-966-01**

Retractor

18 cm 19 mm

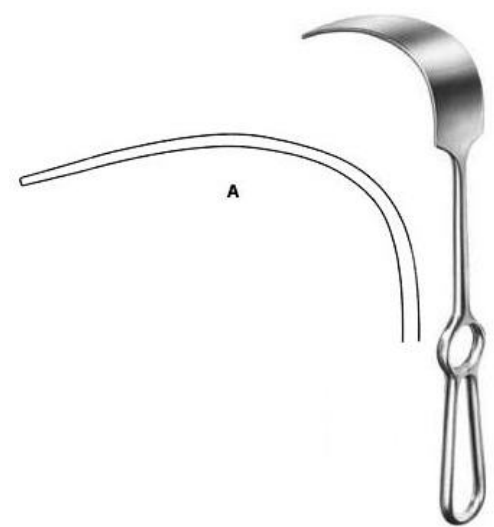

#### Mikulicz

**FI-5-968-01**

Retractor

25 cm 90 x 35 mm, 25 cm 125 x 50 mm, 25 cm 160 x 50 mm





**FISKER**  
INSTRUMENTS

# Surgical Instruments

## Retractors



**Mikulicz**

**FI-5-969-26**

Retractor

26 cm 90 x 55 mm

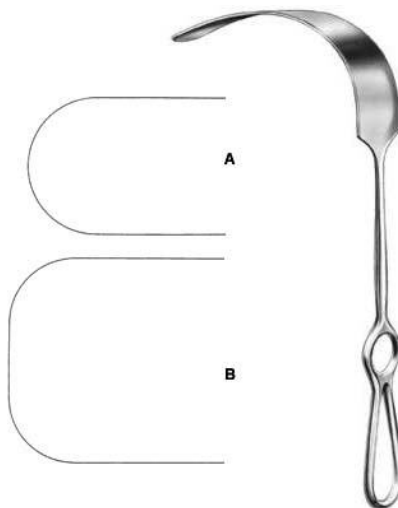

**Kelly**

**FI-5-970-01**

Retractor

27.5 cm 205 x 38 mm, 27.5 cm 205 x 57 mm



**Farabeuf**

**FI-5-971-00**

Retractor

15 cm Fig. 1 = 23 x 16, 15 cm Fig. 1 = 26 x 16, 15 cm Fig. 2 = 27 x 16, 15 cm Fig. 2 = 30 x 16

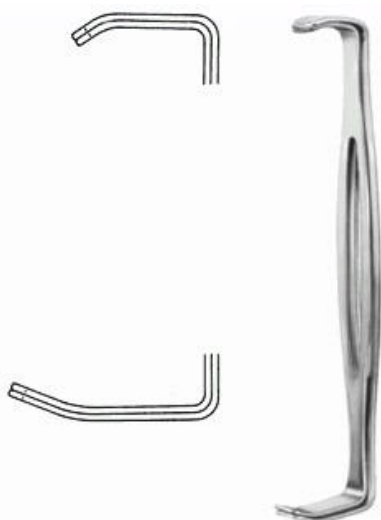

**Parker-Langenbeck**

**FI-5-972-00**

Retractor

21.5 cm Fig. 1 = 21x15 mm, 21.5 cm Fig. 1 = 40x15 mm, 21.5 cm Fig. 2 = 25x15 mm, 21.5 cm Fig. 2 = 45x15 mm



**Alm**

**FI-5-973-07**

Wound Spreaders, self-retaining

7 cm



**Alm**

**FI-5-974-07**

Wound Spreaders, self-retaining

7 cm



**FISKER**  
INSTRUMENTS

## Surgical Instruments

Retractors



### Gosset

**FI-5-975-22**

Abdominal Retractor  
18.5 cm



### Balfour-Baby

**FI-5-976-00**

Abdominal Retractor spreading 90mm, 1 central  
blade 24 x 20 mm  
12.5 cm



### Balfour

**FI-5-977-00**

Abdominal retractor spreading 180 mm, lateral  
blades 70 x 35 mm, 1 central blade  
20 cm

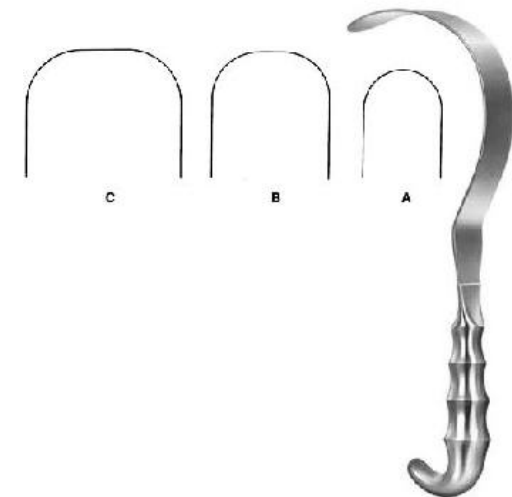

### Deaver

**FI-5-967-04**

Retractor

31.5 cm 25 mm, 31.5 cm 38 mm, 31.5 cm 50 mm,  
31.5 cm 100 mm



**FISKER**  
INSTRUMENTS

# Surgical Instruments

## Probes



**Probe**

**FI-5-1001-11**

Probe

11.5cm, 13 cm , 14.5 cm , 16 cm, 18 cm, 20cm, 25 cm , 30 cm



**Probe**

**FI-5-1002-11**

Probe

11.5 cm, 13 cm , 14.5 cm , 16 cm, 18 cm, 20cm, 25 cm , 30 cm



**Probe**

**FI-5-1003-13**

Probe

13 cm , 14.5 cm , 16 cm, 18 cm, 20 cm, 25 cm



**Probe With Eye**

**FI-5-1004-13**

Probe with eye

13 cm , 14.5 cm , 16 cm

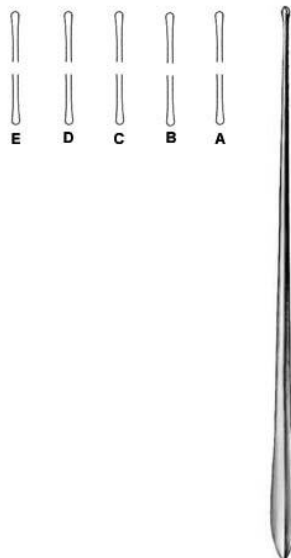

**Myrtle Leaf Probe**

**FI-5-1006-13**

Myrtle Leaf Probe

13 cm , 14.5 cm , 16 cm, 18 cm, 20 cm



**Grooved Director**

**FI-5-1007-13**

Grooved Director

13 cm , 14 cm, 16 cm



**FISKER**  
INSTRUMENTS

## Surgical Instruments

Probes



### Grooved Director

**FI-5-1008-13**

Grooved Director  
13 cm , 14.5 cm , 16 cm



### Doyen

**FI-5-1009-14**

Grooved Director  
14.5 cm



### Nelaton

**FI-5-1010-16**

Grooved Director  
16 cm

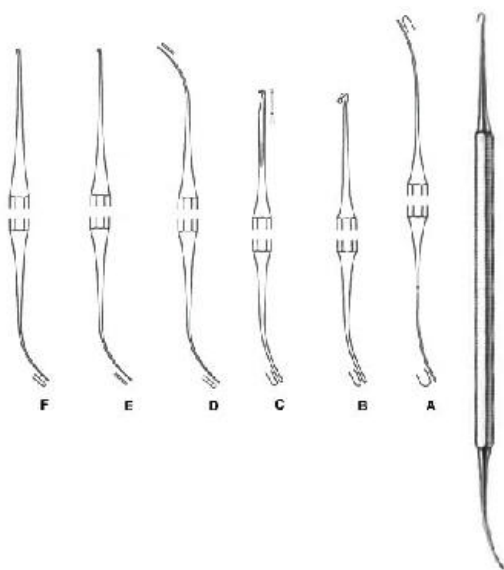

### Varady

**FI-5-1011-01**

Phlebodissector  
18 cm, 17.5 cm



**FISKER**  
INSTRUMENTS

## Surgical Instruments

Plaster

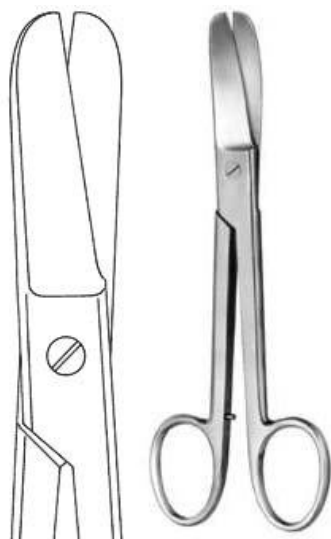

**Lorenz**

**FI-6-101-23**

Bandage Scissors heavy pattern  
23 cm

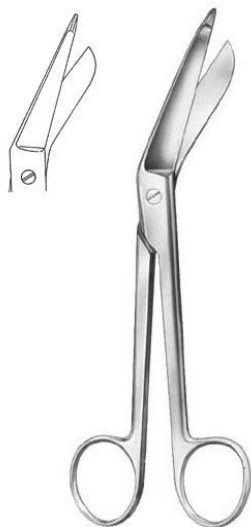

**Lister**

**FI-6-102-14**

Bandage Scissors  
14.5 cm , 18.5 cm , 20 cm



**Bergmann**

**FI-6-103-23**

Plaster Shears  
23.5 cm



**Esmarch**

**FI-6-104-20**

Plaster Shears heavy pattern, short blades  
20 cm



**Bandage Scissors Black Plastic Ring  
With Autodavable**

**FI-6-105-15**

Bandage Scissors black plastic ring with  
autodavable  
16 cm, 19 cm



**Bandage Scissors Black Plastic Rings**

**FI-6-106-18**

Bandage Scissors black plastic rings  
16 cm, 19 cm



**FISKER**  
INSTRUMENTS

## Surgical Instruments

Plaster



**Bruns**

**FI-6-107-24**

Plaster Scissors  
24 cm

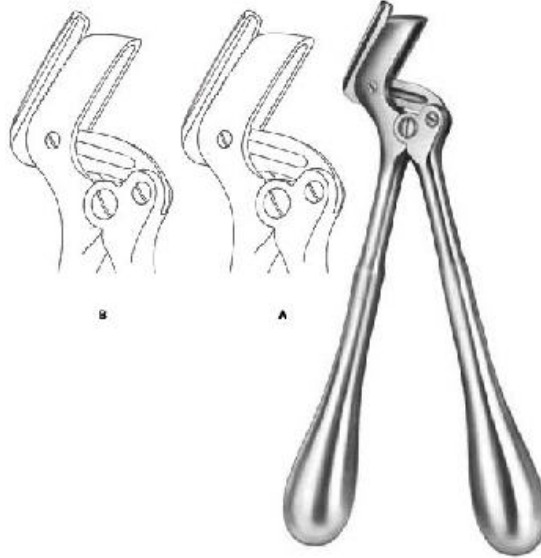

**Stille-Martin**

**FI-6-108-23**

Plaster Shears  
23 cm , 27 cm, 38 cm

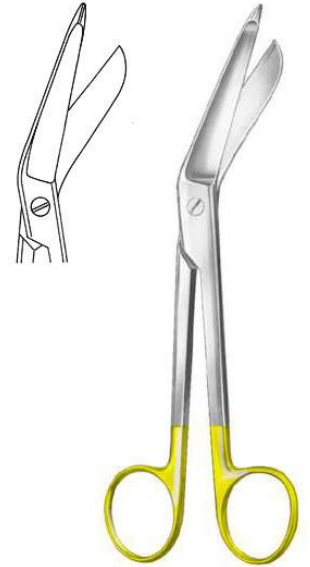

**Lister**

**FI-6-109-18**

Bandage Scissors  
18 cm

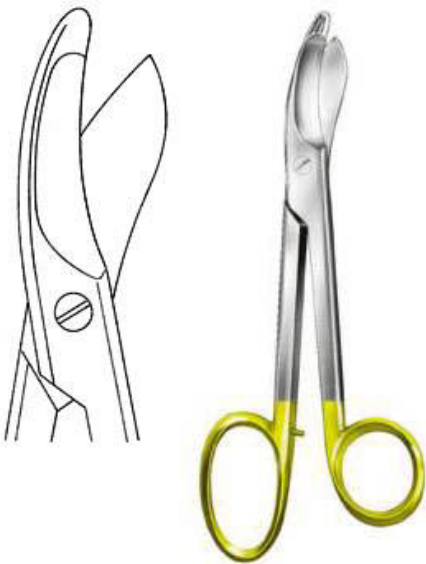

**Bruns**

**FI-6-110-24**

Plaster Scissors  
24 cm



**Hopkins**

**FI-6-111-20**

Plaster Knife with wooden handle  
20 cm



**Reiner**

**FI-6-112-18**

Plaster Knife  
18 cm



**FISKER**  
INSTRUMENTS

## Surgical Instruments

Plaster



**Reiner**

**FI-6-113-18**

Plaster Knife

18 cm



**Martin**

**FI-6-114-21**

Plaster Knife with wooden handle

21 cm



**Engel**

**FI-6-115-14**

Plaster Saw

15.5 cm

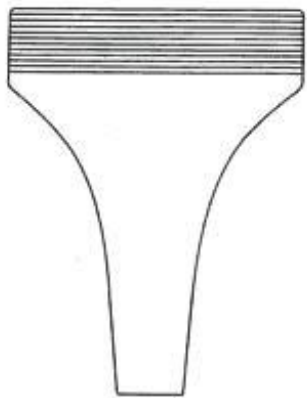

**Hennig**

**FI-6-116-28**

Plaster Spreader

28 cm



**Wolff**

**FI-6-117-18**

Plaster Breaker

18 cm, 26.5 cm



B



A



**FISKER**  
INSTRUMENTS

## Surgical Instruments

Neurosurgery



**Gigli**

**FI-8-101-01**

Wire Saw Handle



**De Martel**

**FI-8-102-33**

Wire Saw Guide  
33 cm



**Crutchfield**

**FI-8-103-01**

Skull Traction Tong small pattern



**Skull Traction Tong Large Pattern**

**FI-8-104-01**

Skull Traction Tong large pattern  
22.5 cm



**Dahlgren**

**FI-8-105-20**

Cranial Rongeur  
20 cm



**Olivecrona-Toennis**

**FI-8-106-14**

Clip Applying Forceps





**FISKER**  
INSTRUMENTS

## Surgical Instruments

Neurosurgery



**McKenzie**

**FI-8-107-19**

Clip Applying Forceps  
18.5 cm



**Olivecrona**

**FI-8-108-18**

Dura Dissector  
18 cm



**Olivecrona**

**FI-8-109-19**

Dura Dissector  
20 cm



**Milligan**

**FI-8-110-21**

Dura Dissector  
21.5 cm



**Davis**

**FI-8-111-21**

Dura Dissector sharp  
21.5 cm



**Dura Dissector**

**FI-8-112-22**

Dura Dissector  
22 cm



**FISKER**  
INSTRUMENTS

## Surgical Instruments

Neurosurgery



**Davis**

**FI-8-113**

Dura Dissector  
24.5 cm



**Love**

**FI-8-114-19**

Nerve Root Retractor  
21.5 cm, 18 cm, 11 cm



**Olivecrona**

**FI-8-115-18**

Brain Spatula  
18 cm



**Scoville**

**FI-8-116-23**

Nerve Root Retractor 8mm  
23.5 cm



**Holsher**

**FI-8-117-24**

Nerve Root Retractor 8mm  
23.5 cm



**Scoville**

**FI-8-118-19**

Nerve Root Retractor 7mm  
16.5 cm



**FISKER**  
INSTRUMENTS

## Surgical Instruments

Neurosurgery



### Groningen

**FI-8-119-26**

Nerve Hook  
26.5 cm



### Groningen

**FI-8-120-26**

Nerve Hook  
26.5 cm



### Cushing

**FI-8-121-19**

Nerve Hook blunt  
19 cm , 28 cm

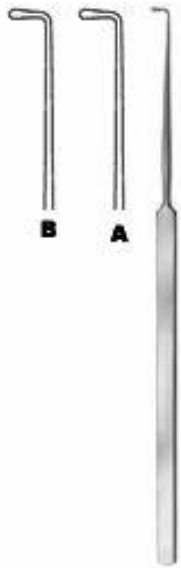

### Cushing

**FI-8-122-19**

Nerve Hook  
19.5 cm , 28 cm



### Smithwick

**FI-8-123-17**

Smithwick  
17 cm , 21 cm



### Halle

**FI-8-125-20**

Dura Knife  
20 cm



**FISKER**  
INSTRUMENTS

## Surgical Instruments

Neurosurgery



**Adson**  
**FI-8-126-20**  
Dura Hook  
20 cm



**Graham**  
**FI-8-127-16**  
Dura Hook blunt  
16.5 cm



**Sachs**  
**FI-8-128-18**  
Dura Hook sharp  
18 cm



**Toennis**  
**FI-8-129-15**  
Dura Hook sharp  
14.5 cm



**Frazier**  
**FI-8-130-13**  
Dura Hook sharp  
13 cm , 18 cm



**Krayenbuhl**  
**FI-8-131-01**  
Nerve and Vessel Hooklet  
18.5 cm Fig. 1 , 18.5 cm Fig. 2



**FISKER**  
INSTRUMENTS

# Surgical Instruments

Neurosurgery



**Cloward**

**FI-8-132-16**

Lamina Spreader

16 cm

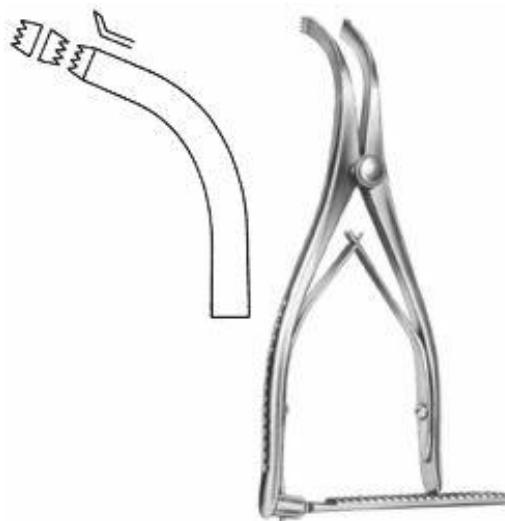

**Inge**

**FI-8-133-17**

Lamina Spreader

16 cm

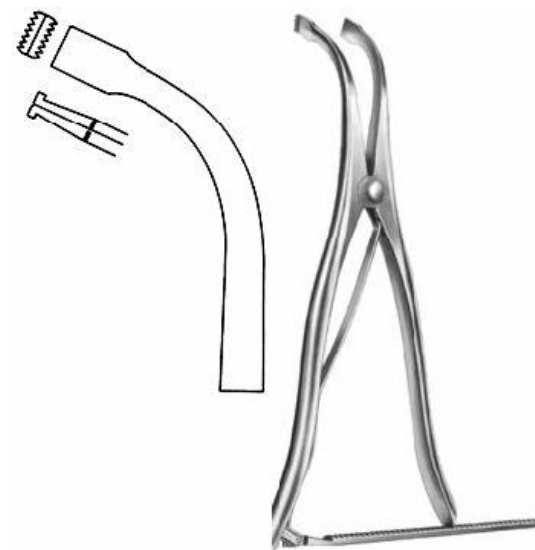

**Inge**

**FI-8-134-27**

Lamina Spreader

25.5 cm

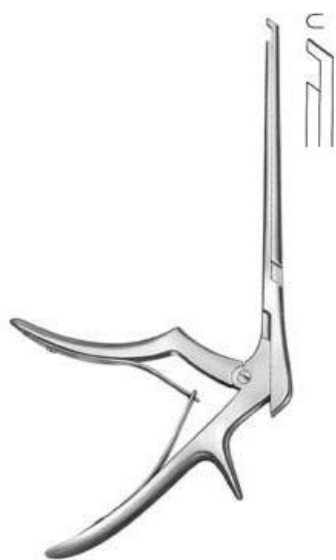

**Ferris-Smith Kerrison**

**FI-8-135-03**

Laminectomy Punch 3mm downwards cutting 40

degree shaft length 180 mm

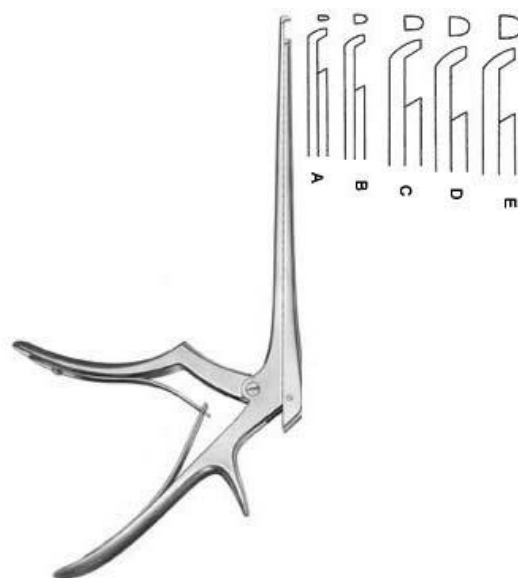

**Ferris-Smith Kerrison**

**FI-8-138-01**

Laminectomy Punch upwards cutting shaft length

180 mm

1 mm, 2 mm, 3 mm, 4 mm, 5 mm, 6 mm

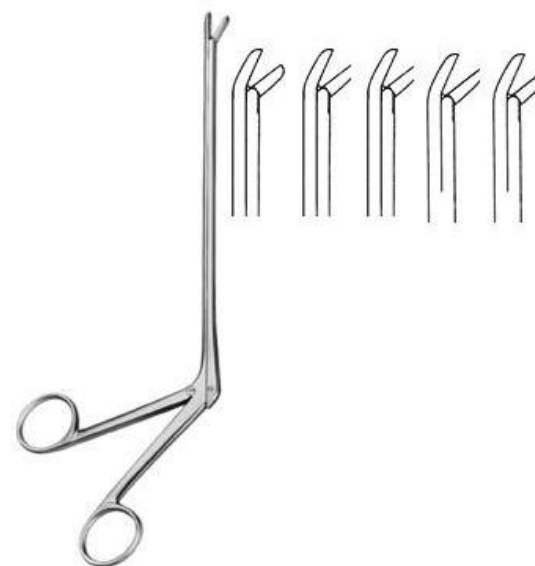

**Cushing**

**FI-8-139-01**

Laminectomy Rongeur jaw 2 x 10 to 4 x 10 mm

straight shaft length 180 mm



**FISKER**  
INSTRUMENTS

## Surgical Instruments

Neurosurgery

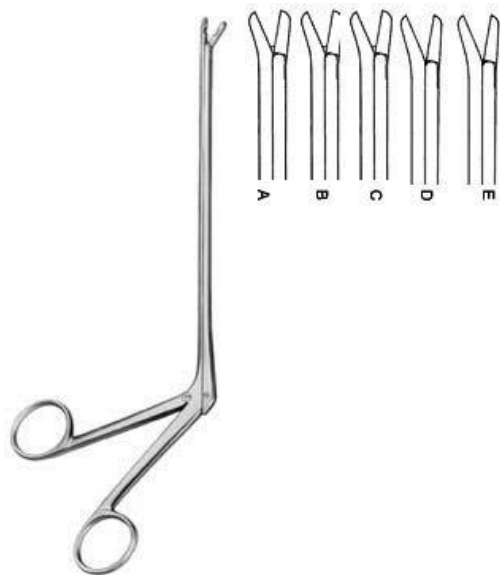

### Cushing

**FI-8-140-01**

Laminectomy Rongeur jaw 2 x 10 to 4 x 10 mm upwards 45 degree shaft  
length 120 mm



### Ferris-Smith Kerrison

**FI-8-137-01**

Laminectomy Punch  
1 mm, 2 mm, 3 mm, 4 mm, 5 mm, 6 mm



**FISKER**  
INSTRUMENTS

## Surgical Instruments

Cardiovascular



**Bone Shear**

**FI-9-101-23**

Bone Shear  
23 cm



**Rib Shear**

**FI-9-102-22**

Rib Shear  
23 cm



**Gluck**

**FI-9-103-22**

Rib Shears  
21 cm



**Giertz-Stille**

**FI-9-104-27**

Rib Shear  
24.5 cm



**Lebsche**

**FI-9-105-24**

Sternum Chisel  
24.5 cm



**Rib Retractor**

**FI-9-106-01**

Rib Retractor lateral blades 12 x 16 mm spreading 95  
mm

Size 1



**FISKER**  
INSTRUMENTS

## Surgical Instruments

Cardiovascular



**Finochietto, Infant**

**FI-9-107-01**

Rib Retractor lateral blades 15 x 15 mm spreading 75

mm  
Size 1



**Finochietto, Baby**

**FI-9-108-01**

Rib Retractor lateral blades 31 x 31 mm spreading 100

mm  
Size 1



**Finochietto**

**FI-9-109-01**

Rib Retractor lateral blades 40 x 45 mm spreading 135

mm  
Size 1



**Burford**

**FI-9-110-01**

Rib Retractor with two pairs of blades 47 x 62 mm + 65 x 62 mm, spreading 200 mm

Size 1



**Castaneda**

**FI-9-111-01**

Rib Retractor lateral blades 10,5 x 32 mm spreading 65

mm  
Size 1



**Finochietto (Modif.)**

**FI-9-112-01**

Rib Retractor lateral blades 14 x 15 mm spreading 120

mm  
Size 1





**FISKER**  
INSTRUMENTS

## Surgical Instruments

Cardiovascular



### Haight

**FI-9-113-90**

Rib Retractor lateral blades 30 x 30 mm spreading 120 mm  
Size 1



### Morse-Favaloro

**FI-9-114-01**

Sternal Retractor 4 movable blades 17 x 22 mm spreading 160 mm Sternal Retractor  
Size 1



### Morse

**FI-9-115-00**

Sternal Retractor 4 movable blades 22 x 27 mm spreading 200 mm  
Size 1



### Tuffier

**FI-9-116-02**

Rib Retractor lateral blades 22 x 27 mm spreading 200 mm  
Size 1

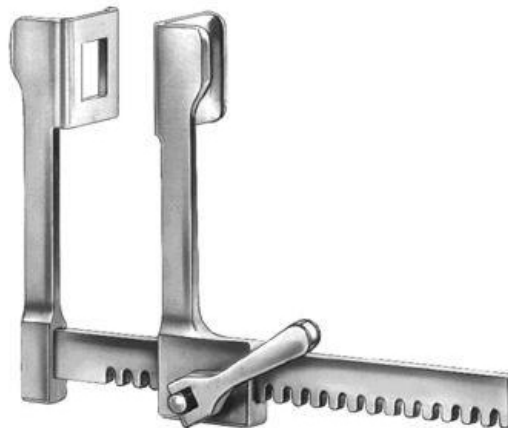

### Finochietto, Baby

**FI-9-117-75**

Rib Retractor lateral blades 14 x 15 mm spreading 75 mm  
Size 1



### Finochietto

**FI-9-118-01**

Rib Retractor lateral blades 30 x 45 mm spreading 150 mm  
Size 1



**FISKER**  
INSTRUMENTS

## Surgical Instruments

Cardiovascular



### DeBakey

**FI-9-119-00**

Rib Retractor spreading 150 mm  
Size 1



### DeBakey

**FI-9-120-00**

Rib Retractor spreading 200 mm  
Size 1



### Thoracic Retractor

**FI-9-121-00**

Thoracic Retractor  
Size 1



### Sellors

**FI-9-121-00**

Rib Contractor  
20 cm



### Bailey-Baby

**FI-9-123-14**

Rib Contractor  
15.5 cm



### Bailey

**FI-9-124-16**

Rib Contractor  
20 cm



**FISKER**  
INSTRUMENTS

## Surgical Instruments

Cardiovascular



**Bailey-Gibbon**

**FI-9-125-16**

Rib Contractor  
20 cm



**Allison**

**FI-9-126-30**

Lung Spatula  
29.5 cm, 32.5 cm



**Price-Thomas**

**FI-9-127-22**

Bronchus Clamp  
22 cm

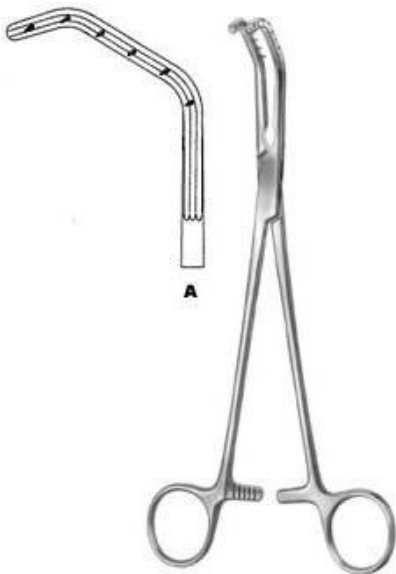

**Price-Thomas**

**FI-9-128-22**

Bronchus Clamp  
22 cm

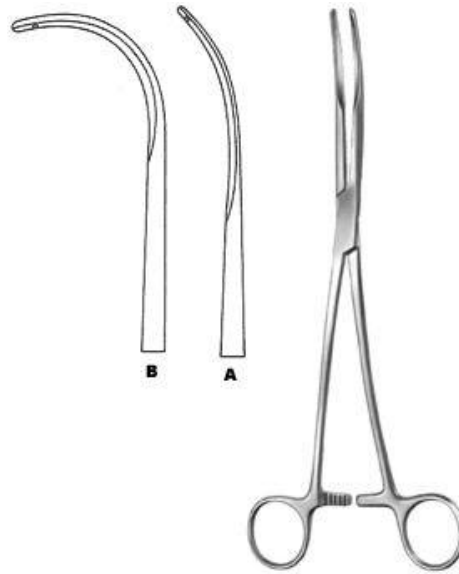

**Semb**

**FI-9-129-24**

Bronchus Clamp  
24.5 cm



**Lovlace**

**FI-9-130-20**

Lung Grasping Forceps  
20.5 cm



**FISKER**  
INSTRUMENTS

## Surgical Instruments

Cardiovascular

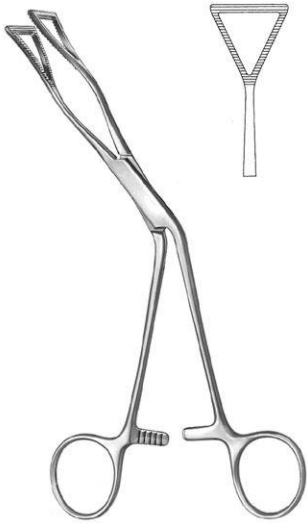

### Lovelace

**FI-9-131-20**

Lung Grasping Forceps  
19 cm



### DeBakey-Satinsky

**FI-9-132-07**

Bulldog Clamp  
7", 9 cm



### Glover

**FI-9-133-06**

Bulldog Clamp  
6 cm



### Santulli

**FI-9-134-07**

Bulldog Clamp  
7



### Gregory, Soft

**FI-9-135-09**

Bulldog Clamp  
9 cm, 11 cm



### Gregory

**FI-9-136-01**

Bulldog Clamp  
10.5 cm



**FISKER**  
INSTRUMENTS

## Surgical Instruments

Cardiovascular

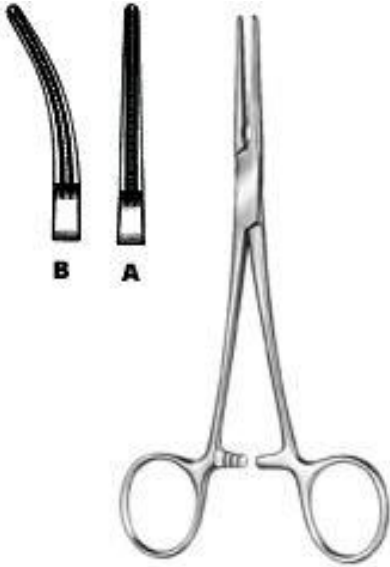

**DeBakey-Rankin**

**FI-9-137-16**

Haemostatic Forceps

16 cm



**DeBakey-Mosquito**

**FI-9-138-15**

Haemostatic Forceps

15 cm



**Ochsner**

**FI-9-139-23**

Aortic Clamp

23.5 cm



**Diethrich**

**FI-9-140-21**

Aortic Clamp

22 cm

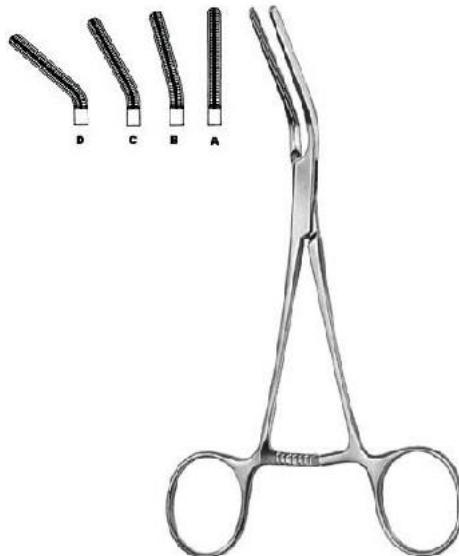

**Dardik**

**FI-9-141-00**

Multi purpose Vascular Clamp

15 cm



**Dale**

**FI-9-142-18**

Peripheral Vascular Clamp

18 cm



**FISKER**  
INSTRUMENTS

## Surgical Instruments

Cardiovascular

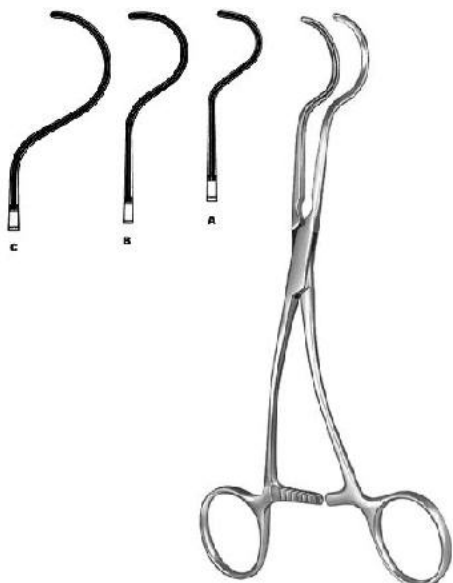

**Dale**

**FI-9-143-17**

Peripheral Vascular Clamp

17.5 cm

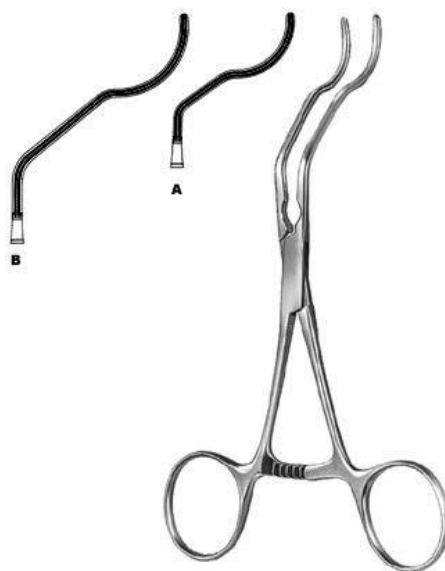

**Gregory**

**FI-9-144-14**

Profunda Clamp

13 cm , 16 cm, 18 cm

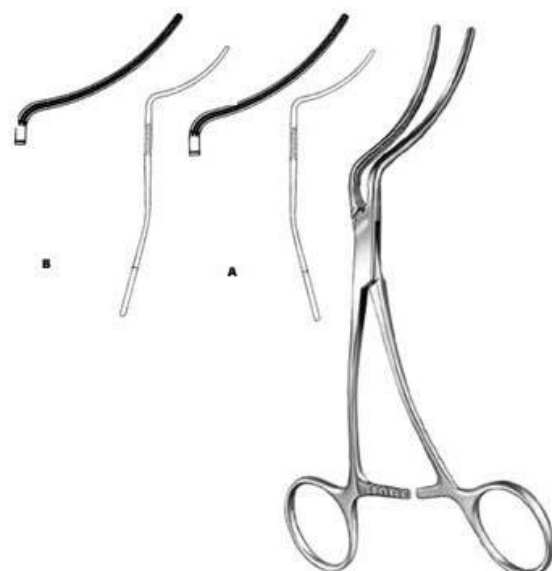

**Martin**

**FI-9-145-16**

Peripheral Vascular Clamp

16.5 cm



**Husfeldt**

**FI-9-146-18**

Peripheral Vascular Clamp

17.5 cm



**Husfeldt**

**FI-9-147-18**

Peripheral Vascular Clamp

18 cm



**Husfeldt**

**FI-9-148-17**

Peripheral Vascular Clamp

17 cm



**FISKER**  
INSTRUMENTS

# Surgical Instruments

Cardiovascular

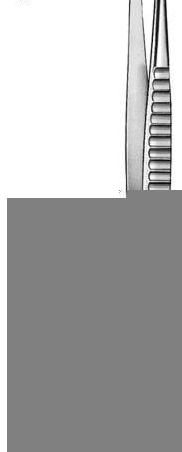

**DeBakey**

**FI-9-149-16**

Vascular Forceps

16 cm



**DeBakey**

**FI-9-150-16**

Vascular Forceps

16 cm



**DeBakey**

**FI-9-151-16**

Vascular Forceps

16 cm



**DeBakey**

**FI-9-152-16**

Vascular Forceps

16 cm



**DeBakey**

**FI-9-153-16**

Vascular Forceps

16 cm



**DeBakey**

**FI-9-154-07**

Bulldog Clamp

7



**FISKER**  
INSTRUMENTS

## Surgical Instruments

Cardiovascular



**DeBakey**

**FI-9-155-07**

Bulldog Clamp

7



**Applying Forceps**

**FI-9-156-23**

Applying Forceps

23.5 cm



**Glover**

**FI-9-157-06**

Bulldog Clamp

7



**Glover**

**FI-9-158-06**

Bulldog Clamp

6.5 cm

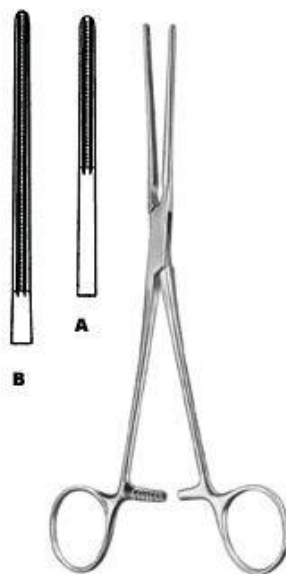

**Potts**

**FI-9-159-21**

Coarctation Clamp

21 cm

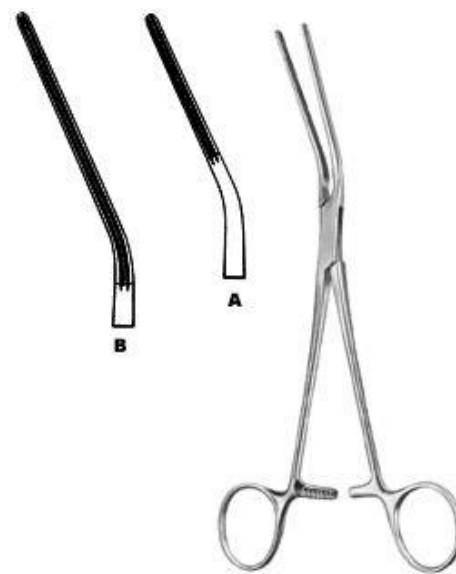

**Potts**

**FI-9-160-21**

Coarctation Clamp

20.5 cm





**FISKER**  
INSTRUMENTS

## Surgical Instruments

Cardiovascular

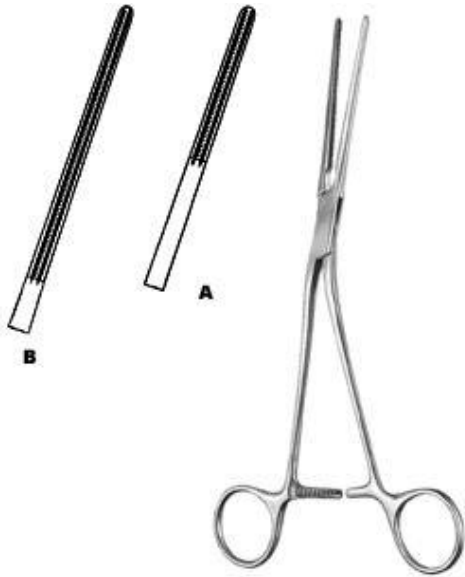

**Potts**

**FI-9-161-21**

Coarctation Clamp  
20.5 cm



**Potts**

**FI-9-162-22**

Anastomosis Clamp  
21.5 cm



**Potts**

**FI-9-163-22**

Anastomosis Clamp  
22 cm

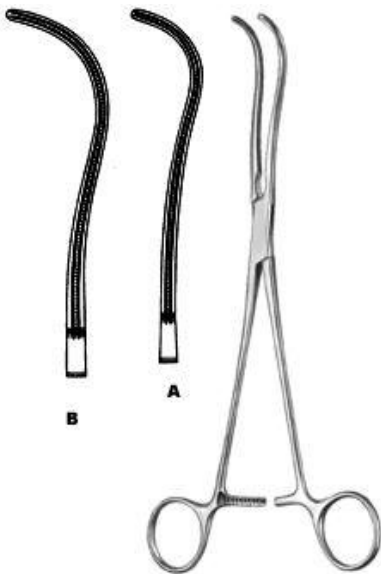

**DeBakey**

**FI-9-164-19**

Ligature Forceps  
19 cm



**DeBakey**

**FI-9-165-16**

Peripheral Vascular Clamp  
16 cm



**DeBakey**

**FI-9-166-19**

Peripheral Vascular Clamp  
16 cm



**FISKER**  
INSTRUMENTS

## Surgical Instruments

Cardiovascular

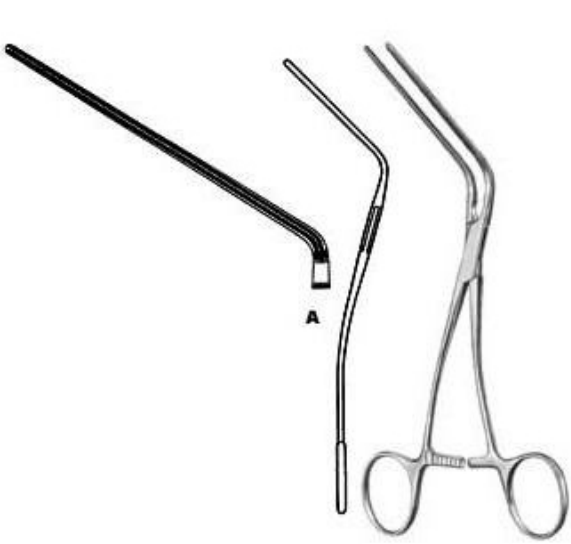

### Leland-Jones

**FI-9-167-18**

Peripheral Vascular Clamp

18 cm



### Bainbridge

**FI-9-168-15**

Multi purpose Vascular Clamp

15 cm

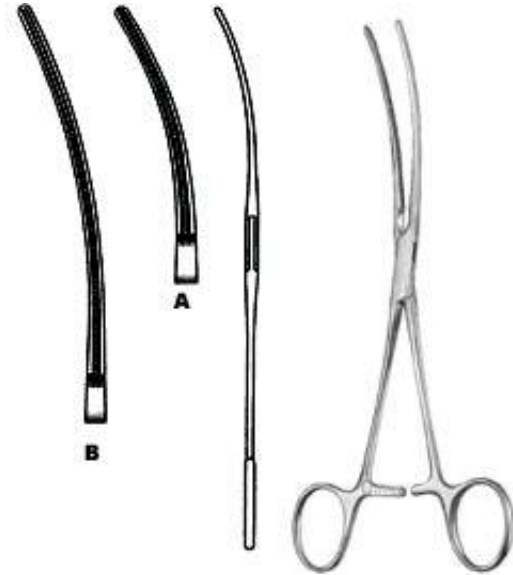

### Bainbridge

**FI-9-169-15**

Multi purpose Vascular Clamp

15 cm

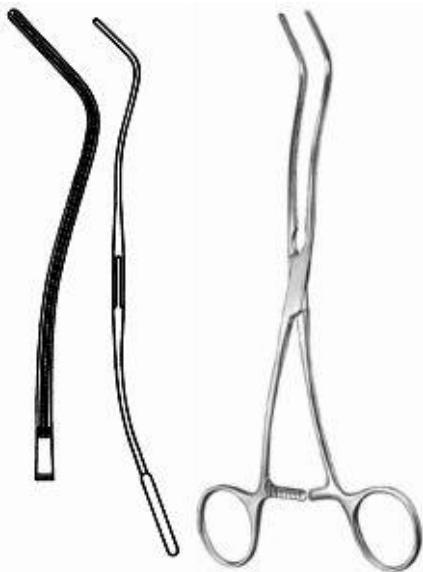

### DeBakey

**FI-9-170-20**

Multi purpose Vascular Clamp

20 cm



### DeBakey

**FI-9-171-26**

Aortic Aneurysm Clamp

26 cm



### DeBakey

**FI-9-172-28**

Aortic Aneurysm Clamp

28 cm



**FISKER**  
INSTRUMENTS

## Surgical Instruments

Cardiovascular

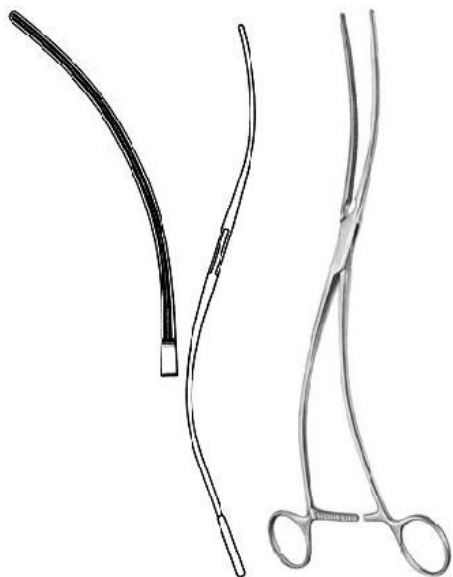

**DeBakey**

**FI-9-173-30**

Aortic Aneurysm Clamp

30 cm



**DeBakey**

**FI-9-174-27**

Aortic Clamp

27 cm



**DeBakey**

**FI-9-175-24**

Ligature Forceps

24.5 cm



**DeBakey**

**FI-9-176-24**

Ligature Forceps

24.5 cm



**DeBakey**

**FI-9-178-25**

Ligature Forceps

27 cm

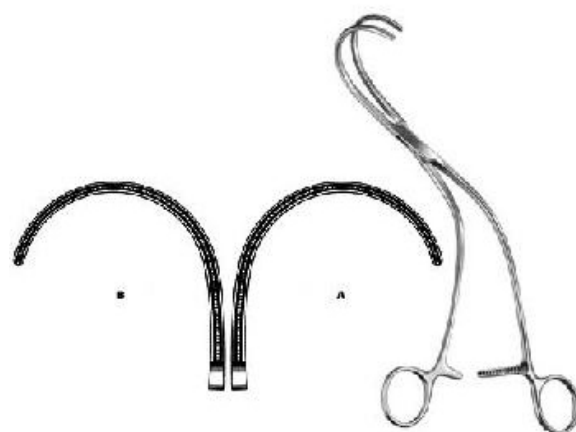

**Weber**

**FI-9-179-01**

Aortic Clamp

24 cm



**FISKER**  
INSTRUMENTS

## Surgical Instruments

Cardiovascular

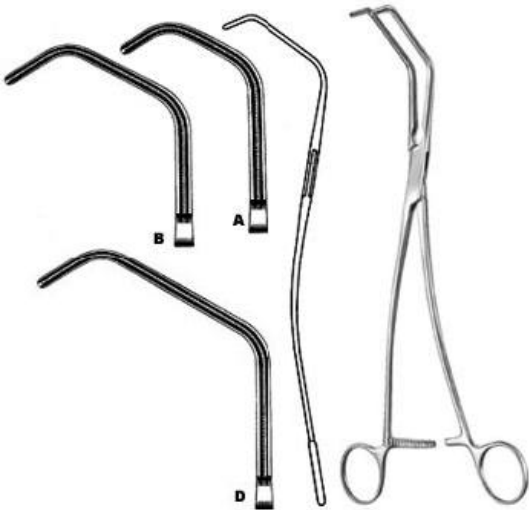

### Satinsky

FI-9-180-20

Tangential Occlusion Clamp  
22 cm

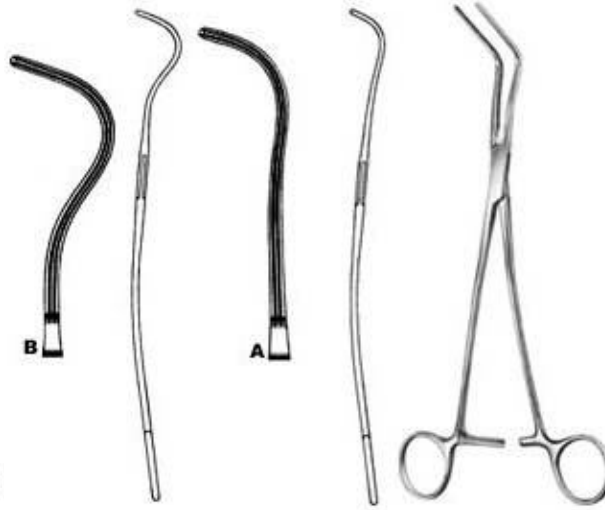

### Harken

FI-9-181-01

Auricle Clamp  
24.5 cm



### Lees

FI-9-182-23

Bronchus Clamp  
23 cm



### Lees

FI-9-183-25

Bronchus Clamp  
25 cm



### Lambert-Kay

FI-9-184-21

Anastomosis Clamp  
22.5 cm



### DeBakey

FI-9-185-17

Anastomosis Clamp  
16.5 cm



**Morris-DeBakey**

**FI-9-186-18**

Aortic Clamp

16.5 cm



**DeBakey-Bahnsen**

**FI-9-187-23**

Aneurysm Clamp

23.5 cm

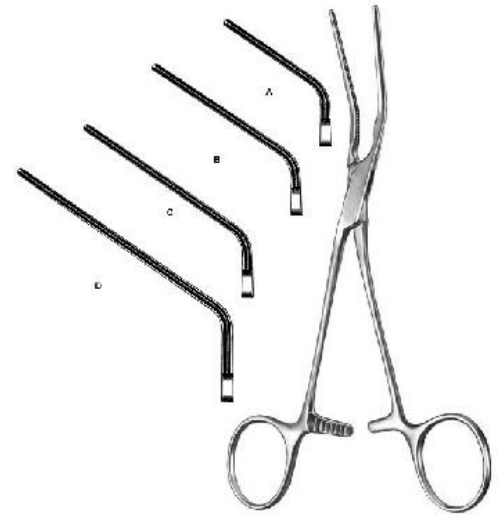

**DeBakey**

**FI-9-188-20**

Multi purpose Vascular Clamp

18 cm

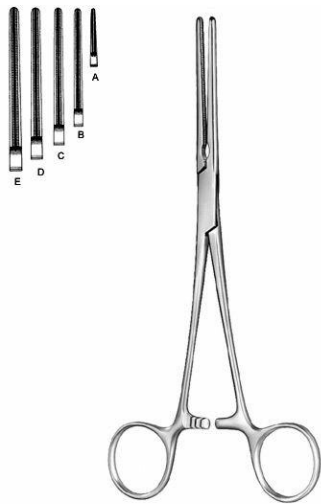

**DeBakey-Mosquito**

**FI-9-189-12**

Haemostatic Forceps

12.5 cm



**DeBakey-Mosquito**

**FI-9-190-12**

Haemostatic Forceps

12.5 cm



**DeBakey**

**FI-9-191-17**

Multi purpose Vascular Clamp

17 cm



**FISKER**  
INSTRUMENTS

## Surgical Instruments

Cardiovascular



**DeBakey**

**FI-9-192-16**

Multi purpose Vascular Clamp  
16.5 cm

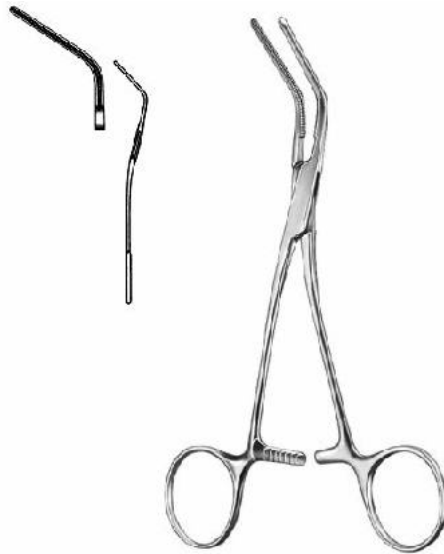

**DeBakey**

**FI-9-193-15**

Multi purpose Vascular Clamp  
16 cm

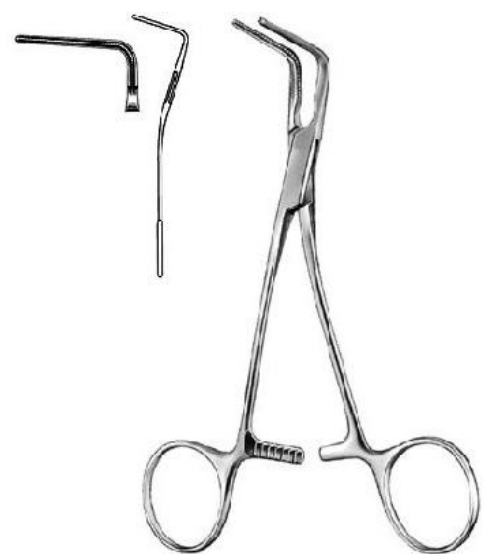

**DeBakey**

**FI-9-194-15**

Multi purpose Vascular Clamp  
16.5 cm



**DeBakey**

**FI-9-195-17**

Multi purpose Vascular Clamp  
16.5 cm



**Glover**

**FI-9-196-17**

Multi purpose Vascular Clamp  
17 cm



**Glover**

**FI-9-197-17**

Multi purpose Vascular Clamp  
17.5 cm



**FISKER**  
INSTRUMENTS

## Surgical Instruments

Cardiovascular

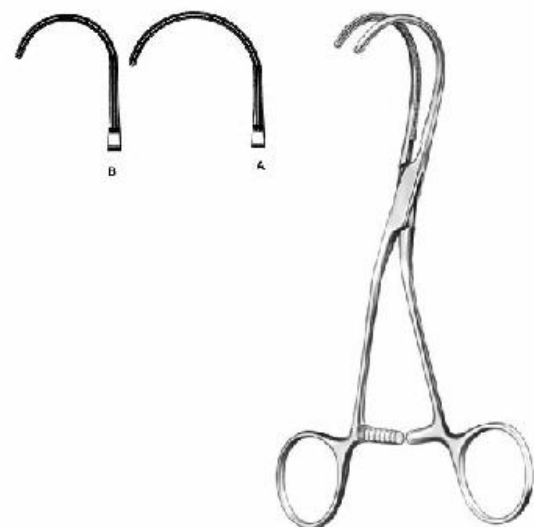

### DeBakey

FI-9-198-16

Multi purpose Vascular Clamp

16.5 cm

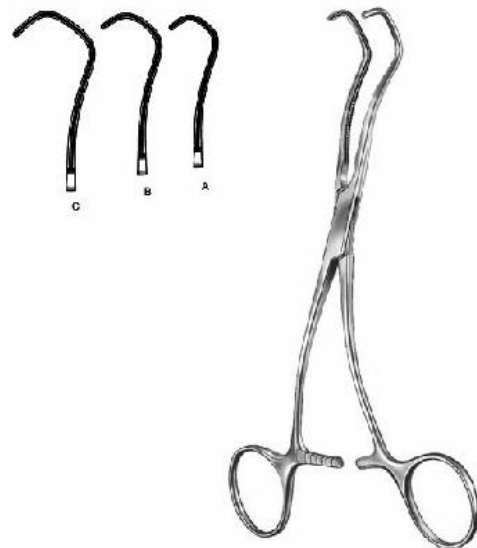

### Derra

FI-9-199-16

Anastomosis Clamp

16 cm Fig. 1, 17.5 cm Fig. 3, 18.5 cm Fig. 3



### DeBakey-Beck

FI-9-200-17

Anastomosis Clamp

17 cm



### Cooley

FI-9-201-16

Vascular Forceps

16 cm

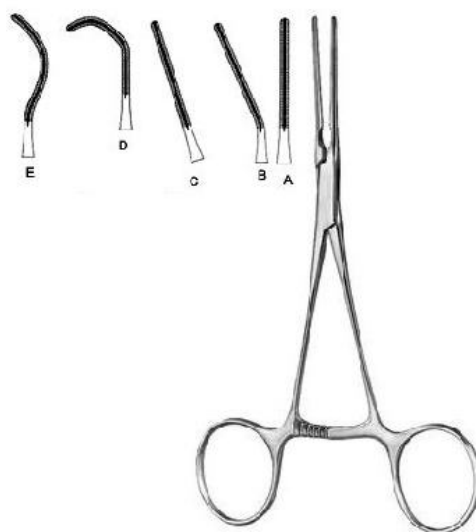

### Cooley

FI-9-202-01

Pediatric Vascular Clamp

14.5 cm



### Cooley

FI-9-203-21

Iliac Clamp

22 cm



**FISKER**  
INSTRUMENTS

## Surgical Instruments

Cardiovascular



**Cooley**  
**FI-9-204-17**  
Anastomosis Clamp  
17 cm

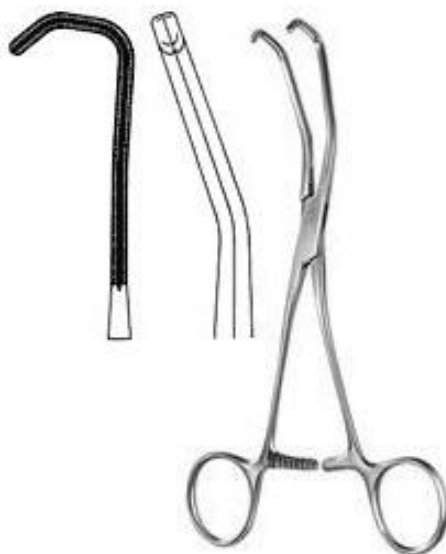

**Cooley**  
**FI-9-205-17**  
Anastomosis Clamp  
20 cm



**Cooley**  
**FI-9-206-16**  
Anastomosis Clamp  
17 cm



**Cooley**  
**FI-9-207-15**  
Multi purpose Vascular Clamp  
16 cm



**Cooley**  
**FI-9-208-17**  
Multi purpose Vascular Clamp  
17 cm



**Cooley**  
**FI-9-209-17**  
Multi purpose Vascular Clamp  
17 cm





**FISKER**  
INSTRUMENTS

# Surgical Instruments

Cardiovascular



**Cooley**

**FI-9-210-17**

Multi purpose Vascular Clamp  
17.5 cm

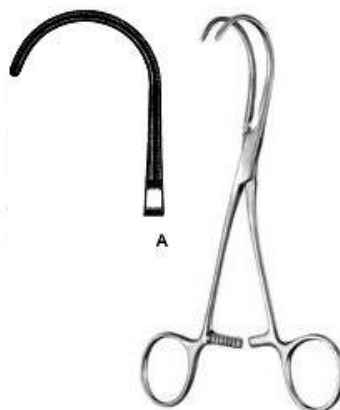

**Cooley**

**FI-9-211-16**

Multi purpose Vascular Clamp  
16.5 cm



**Cooley-Derra**

**FI-9-212-16**

Anastomosis Clamp  
16.5 cm



**Cooley-Beck**

**FI-9-213-17**

Anastomosis Clamp  
17 cm

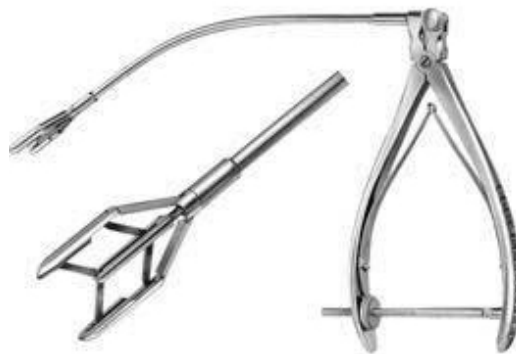

**Cooley**

**FI-9-214-00**

Aortic Dilator

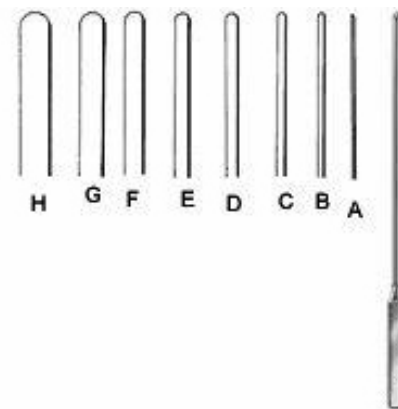

**Cooley**

**FI-9-215-05**

Vascular Dilator  
14 cm / 5 ø 11



**FISKER**  
INSTRUMENTS

# Surgical Instruments

Cardiovascular



**DeBakey**  
**FI-9-216-05**

Vascular Dilator  
19 cm



**Martin**

**FI-9-217-00**

Tunneling Set complete set with three shafts, two handles and 12 tips in storage case.



**Hach**

**FI-9-218-01**

Fasciotomy Knife with plastic handle  
30 cm



**Intima Spatula**

**FI-9-219-18**

Intima Spatula  
18.5 cm

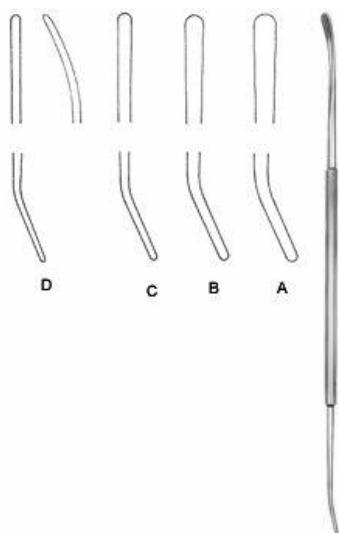

**Robb**

**FI-9-220-01**

Vascular Dissector  
24 cm Fig. 1 2,5 mm ? , 24 cm Fig. 2 2,0 mm ?



**Crile**

**FI-9-221-20**

Nerve Hooklet  
20 cm

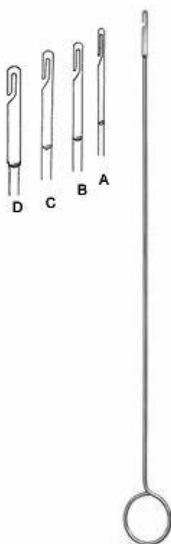

**Ligature Catcher**

**FI-9-222-15**

Ligature Catcher  
26 cm 1,5 mm



**Subramanian-Miniature**

**FI-9-223-15**

Aortic Clamp 135 degree  
15.5 cm

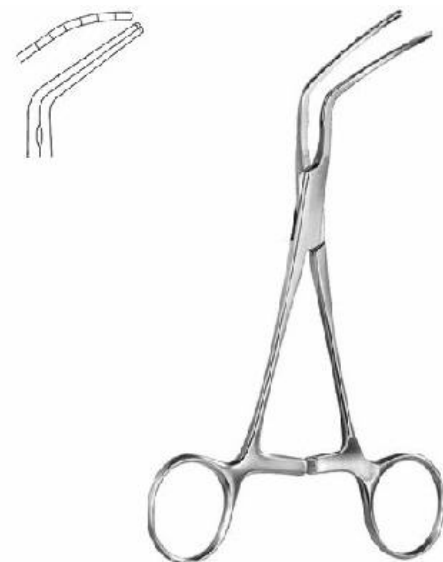

**Subramanian**

**FI-9-224-16**

Aortic Clamp  
16 cm

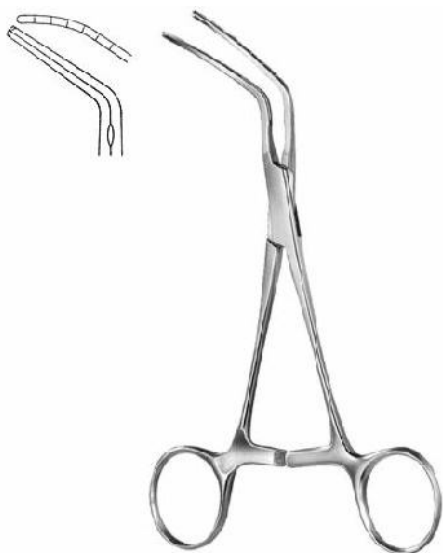

**Subramanian**

**FI-9-225-16**

Aortic Clamp

14 cm Fig. 1, 14 cm Fig. 2, 14 cm Fig. 3

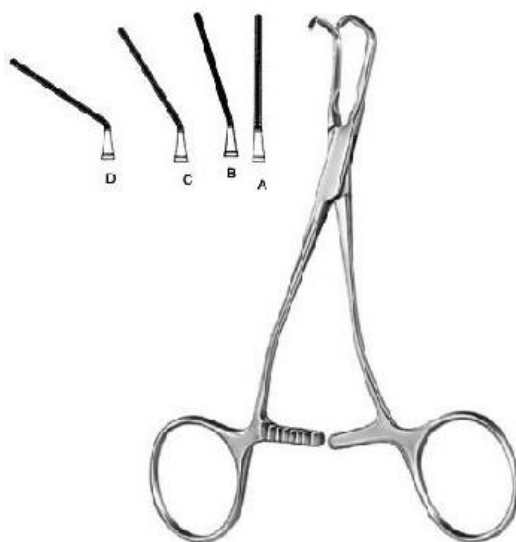

**Pediatric Vascular Clamp**

**FI-9-226-01**

Pediatric Vascular Clamp



**Pediatric Vascular Clamp**

**FI-9-227-16**

Pediatric Vascular Clamp

16.5 cm



**FISKER**  
INSTRUMENTS



**Pediatric Vascular Clamp**

**FI-9-228-16**

Pediatric Vascular Clamp

16 cm



**FISKER**  
INSTRUMENTS

## Surgical Instruments

Tracheotomy

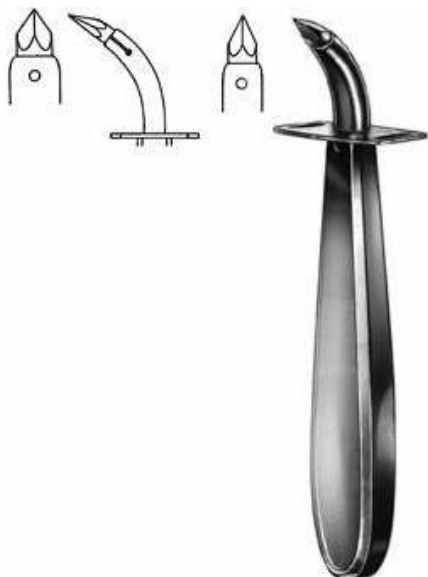

### Ueckermann

**FI-16-101-13**

Tracheotomy Trocar

11.5 cm



### Iterson

**FI-16-102-16**

Tracheal Hook

17 cm



### Rose

**FI-16-103-13**

Tracheal Hook

13.5 cm



### Luer

**FI-16-104-11**

Tracheal Hook

11 cm

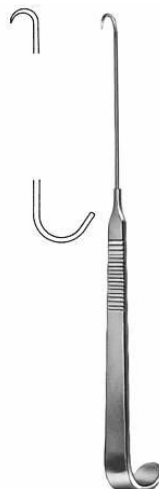

### Tracheal Hook

**FI-16-105-15**

Tracheal Hook

15 cm



### Lukens

**FI-16-106-17**

Thymus Retractor

17.5 cm



**FISKER**  
INSTRUMENTS

## Surgical Instruments

Tracheotomy

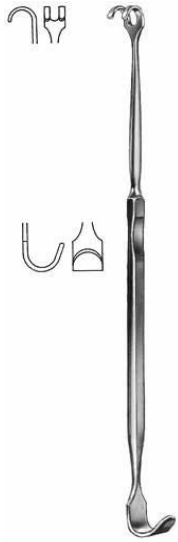

### Jackson

**FI-16-107-17**

Tracheal Hook

18 cm



### Kocher

**FI-16-108-15**

Goitre Enucleator

16.5 cm



### Kocher

**FI-16-109-15**

Goitre Enucleator

16.5 cm



### Hofmeister

**FI-16-110-21**

Goitre Enucleator

20.5 cm



### Lahey

**FI-16-111-15**

Goitre Grasping Forceps

15.5 cm



### Luer

**FI-16-112-04**

Tracheal Tube



**FISKER**  
INSTRUMENTS

## Surgical Instruments

Tracheotomy



### Luer

**FI-6-113-08**

Tracheal Tube



### Chevalier-Jackson

**FI-16-114-04**

Tracheal Tube outer tube closed inner tube  
closed silver



### Speaking Tube

**FI-16-115-08**

Speaking Tube



**FISKER**  
INSTRUMENTS

## Surgical Instruments

Dermatology



**Moncorps**  
**FI-17-101-14**  
Milium Knife  
14 cm



**Moncorps**  
**FI-17-102-00**  
Spare Blade



**Vidal**  
**FI-17-103-14**  
Lupus Scraper  
13 cm



**Wolff**  
**FI-17-105-01**  
Lupus Curette  
14 cm



**Kilner**  
**FI-17-106-15**  
Skin Hooklet  
14.5 cm



**Gillies**  
**FI-17-107-18**  
Skin Hooklet  
18 cm





**FISKER**  
INSTRUMENTS

## Surgical Instruments

Dermatology



### Kaye

**FI-17-108-03**

Face-lift Hook

13 cm

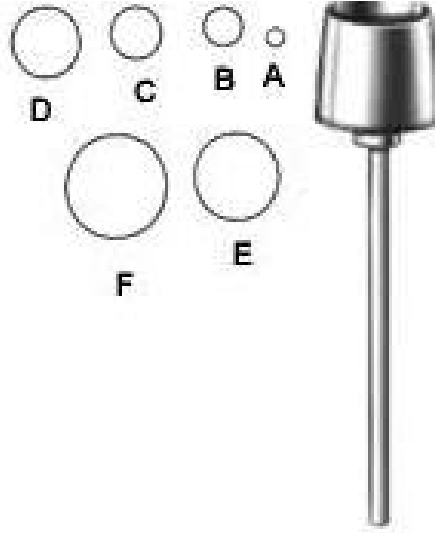

### Dermal Punch

**FI-17-109-02**

Dermal Punch

5.5 cm



### Handle

**FI-17-110-00**

Handle

8 cm

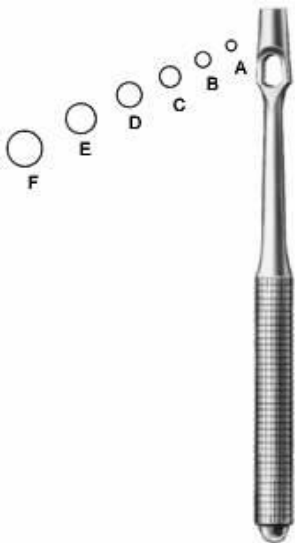

### Keys

**FI-17-111-02**

Dermal Punch

11 cm



### Unna

**FI-17-113-14**

Comedone Extractor

14.5 cm



### Saalfeld

**FI-17-114-10**

Comedone Extractor

11 cm



**FISKER**  
INSTRUMENTS

## Surgical Instruments

Dermatology



### Saalfeld

**FI-17-115-14**

Saalfeld Comedone Extractor

14.5 cm



### Schamberg

**FI-17-116-10**

Comedone Extractor

9.5 cm



### Katsch

**FI-17-117-14**

Comedone Extractor

16 cm



### Unna-Vidal

**FI-17-118-11**

Comedone Extractor

11.5 cm



### D'Assump?

**FI-17-119-15**

Face-lift Forceps

18 cm

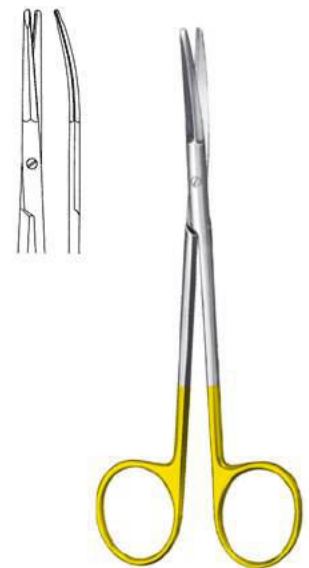

### Gregory

**FI-17-120-14**

Face-lift Scissors

14 cm



**FISKER**  
INSTRUMENTS

## Surgical Instruments

Dermatology

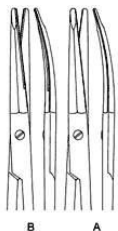

### Kaye

**FI-17-121-15**

Face-lift Scissors  
15 cm, 18 cm



### Stella-S

**FI-17-122-18**

Face-lift Scissors  
18 cm



### Gorney

**FI-17-123-18**

Face-lift Scissors  
18 cm

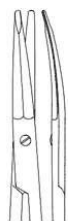

### Freeman-Kaye

**FI-17-124-18**

Face-lift Scissors  
18 cm



### Freeman

**FI-17-125-00**

Face-lift Scissors  
23 cm



### Fox

**FI-17-104-01**

Lupus Curette  
14 cm



**FISKER**  
INSTRUMENTS

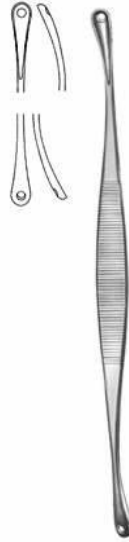

**Unna**

**FI-17-112-14**

Comedone Extractor

14.5 cm



**Allis-Baby**  
**FI-18-101-12**

Intestinal and Tissue Grasping Forceps  
13 cm

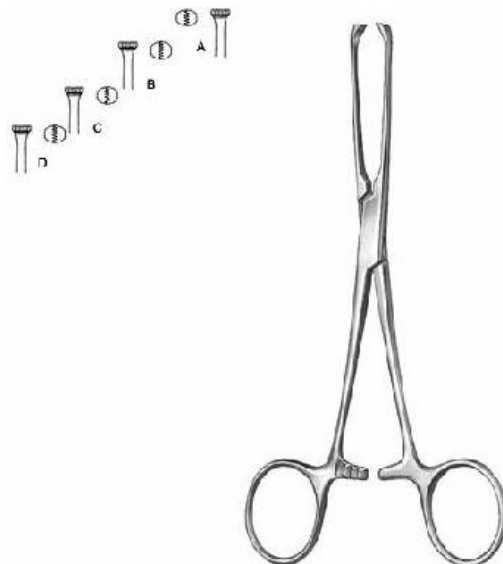

**Allis**

**FI-18-102-15**

Intestinal and Tissue Grasping Forceps  
15.5 cm, 19 cm, 25.5 cm

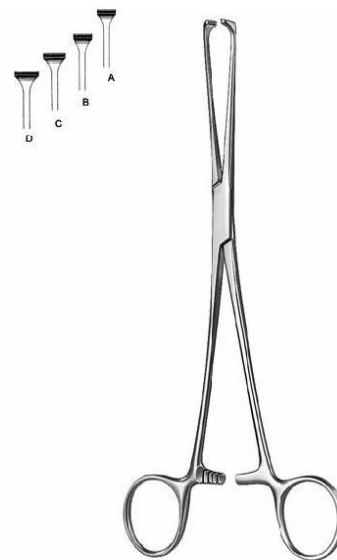

**Allis**

**FI-18-103-16**

Intestinal and Tissue Grasping Forceps  
15.5 cm, 20 cm, 24.5 cm, 30 cm



**Allis-Adair**  
**FI-18-104-15**

Intestinal and Tissue Grasping Forceps  
16 cm



**Boys-Allis**  
**FI-18-105-15**

Intestinal and Tissue Grasping Forceps  
15.5 cm



**Thoms-Allis**  
**FI-18-106-20**

Intestinal and Tissue Grasping Forceps  
20.5 cm



**FISKER**  
INSTRUMENTS

# Surgical Instruments

## Intestines & Stomach



**Allis**

**FI-18-107-20**

Intestinal and Tissue Grasping Forceps

20 cm

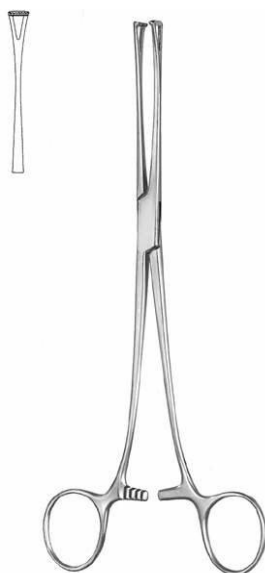

**Lockwood**

**FI-18-108-20**

Intestinal and Tissue Grasping Forceps

20 cm



**Williams**

**FI-18-109-16**

Intestinal and Tissue Grasping Forceps

16.5 cm



**Babcock**

**FI-18-110-16**

Intestinal and Tissue Grasping Forceps

16.5 cm, 21 cm

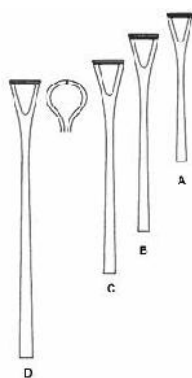

**Babcock**

**FI-18-111-16**

Intestinal and Tissue Grasping Forceps

15.5 cm, 17.5 cm, 21 cm, 24 cm

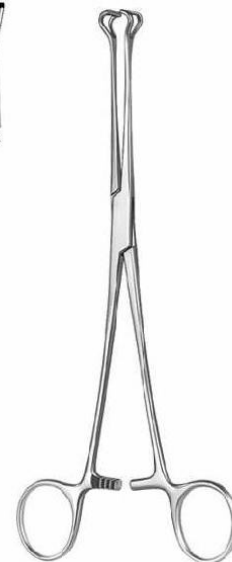
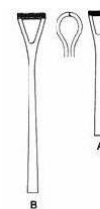

**Babcock**

**FI-18-112-16**

Intestinal and Tissue Grasping Forceps

16.5 cm, 25.5 cm



**FISKER**  
INSTRUMENTS

# Surgical Instruments

## Intestines & Stomach



**Duval**

**FI-18-113-20**

Intestinal and Tissue Grasping Forceps

20.5 cm

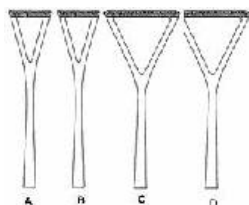

**Duval**

**FI-18-114-18**

Intestinal and Tissue Grasping Forceps

18 cm, 25.5 cm, 23 cm

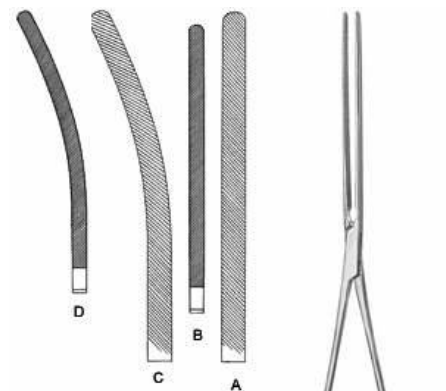

**Doyen**

**FI-18-115-21**

Intestinal Clamp

21.5 cm, 23.5 cm

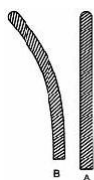

**Doyen-Baby**

**FI-18-116-18**

Intestinal Clamp

18 cm, 17.5 cm

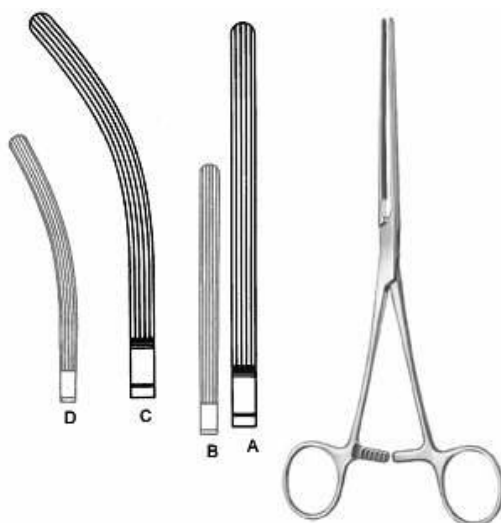

**Mayo-Robson**

**FI-18-117-21**

Intestinal Clamp

21.5 cm, 23.5 cm, 23 cm

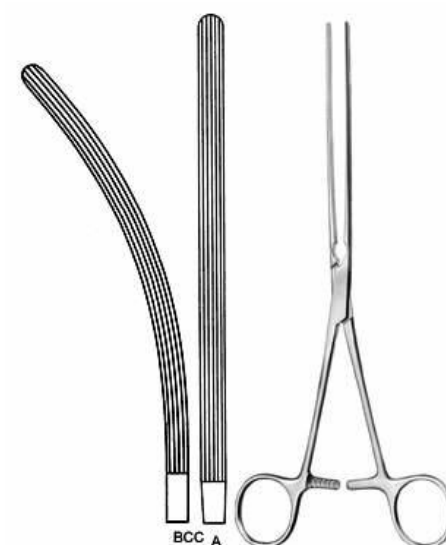

**Mayo-Robson**

**FI-18-118-25**

Intestinal Clamp

25.5 cm, 24.5 cm

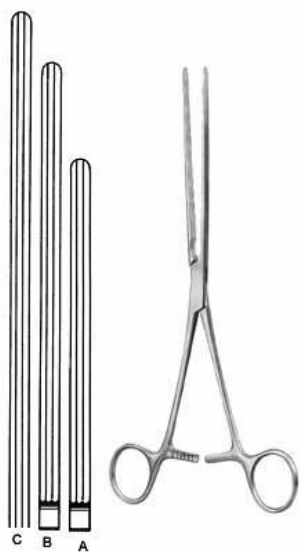

**Kocher**

**FI-18-119-22**

Intestinal Clamp

22.5 cm, 25 cm, 28.5 cm

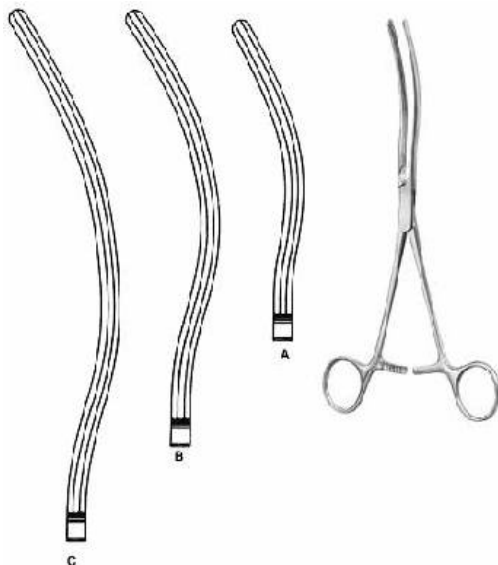

**Kocher**

**FI-18-120-22**

Intestinal Clamp

22 cm, 24.5 cm, 27.5 cm



**Allen**

**FI-18-121-16**

Intestinal Clamp

16 cm



**Payr-Baby**

**FI-18-122-15**

Intestinal and Pylorus Clamp

15 cm

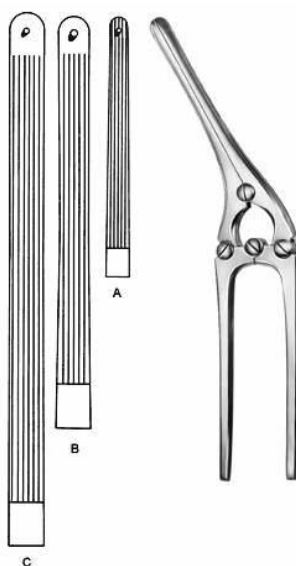

**Payr**

**FI-18-123-21**

Intestinal and Pylorus Clamp

20.5 cm, 29 cm, 34.5 cm



**Stone-Watt**

**FI-18-124-07**

Intestinal Anastomosis Clamp

8.5 cm, 10 cm





**Stone-Watt**  
**FI-18-125-15**  
Closing Forceps

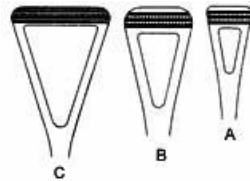

**Scheibe**  
**FI-18-126-18**  
Organ Grasping Forceps  
18 cm

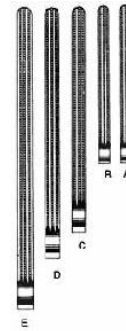

**Doyen-Baby**  
**FI-18-127-13**  
Intestinal Clamp  
14 cm, 17 cm

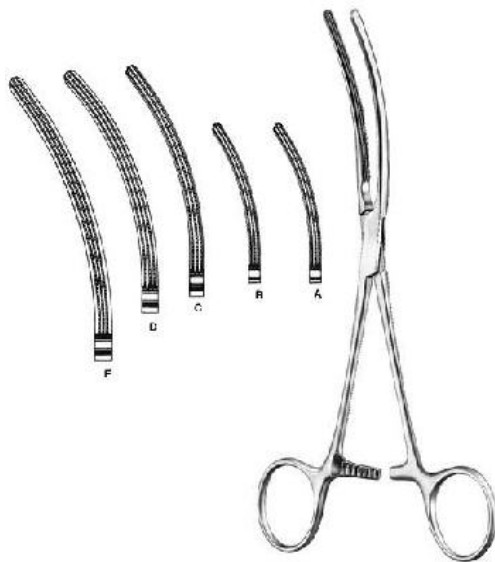

**Doyen-Baby**  
**FI-18-128-13**  
Intestinal Clamp  
13.5 cm, 17 cm



**Mayo-Robson**  
**FI-18-129-25**  
Intestinal Clamp  
26 cm



**Mayo-Robson**  
**FI-18-130-25**  
Intestinal Clamp  
25 cm

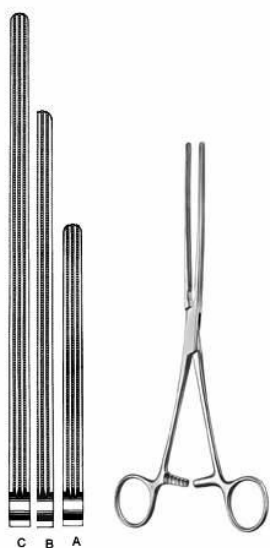

**Kocher**

**FI-18-131-22**

Intestinal Clamp  
22.5 cm, 28 cm

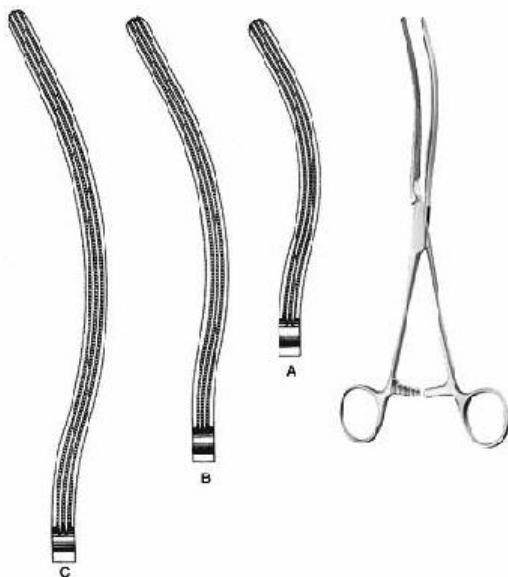

**Kocher**

**FI-18-132-22**

Intestinal Clamp  
22 cm, 25 cm, 27.5 cm

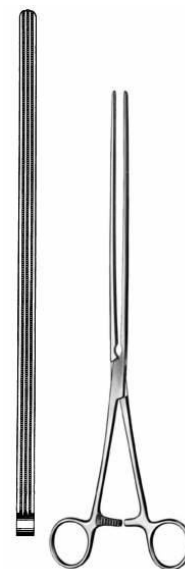

**Scudder**

**FI-18-133-33**

Intestinal Clamp  
33.5 cm

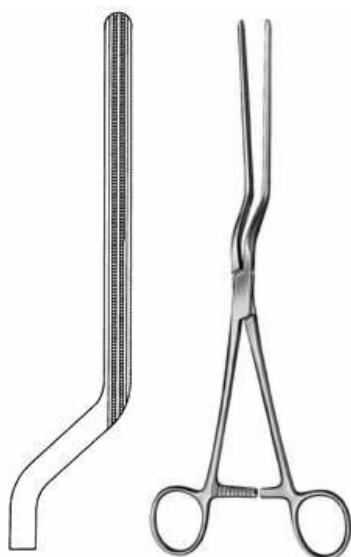

**Brunner**

**FI-18-134-24**

Sigmoid Anastomosis Forceps  
27 cm

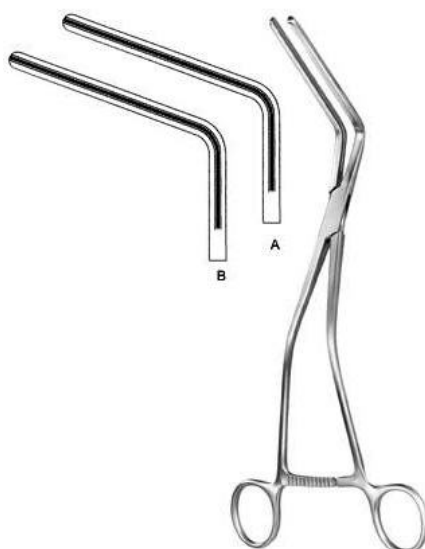

**Hayes**

**FI-18-135-26**

Sigmoid Anastomosis Forceps  
27 cm, 28 cm



**Veidenheimer**

**FI-18-136-23**

Sigmoid Anastomosis Forceps  
25 cm



**FISKER**  
INSTRUMENTS

## Surgical Instruments

Intestines & Stomach



### Fehland

**FI-18-137-24**

Sigmoid Anastomosis Forceps  
24 cm

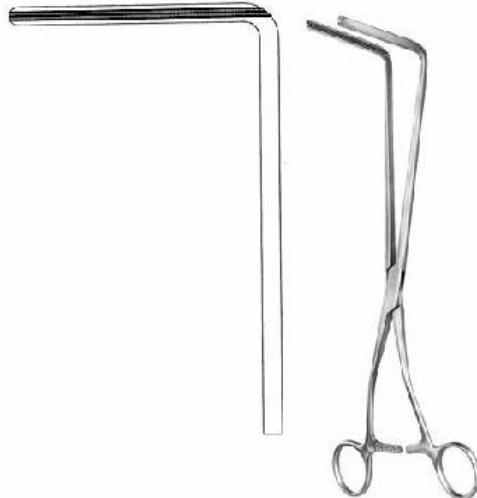

### Resano

**FI-18-138-30**

Sigmoid Anastomosis Forceps  
28 cm



### Sims

**FI-18-139-15**

Rectal Speculum  
15.5 cm



### Sims

**FI-18-140-15**

Rectal Speculum  
15.5 cm



### Mathieu

**FI-18-141-19**

Rectal Speculum  
19 cm



### Alan-Parks

**FI-18-142-00**

Alan-Parks  
14 cm



**FISKER**  
INSTRUMENTS

## Surgical Instruments

Intestines & Stomach



### McGinvey

**FI-18-143-19**

Hemorrhoidal Grasping Forceps

19 cm



### Handle For Biopsy Forceps

**FI-18-144-00**

Handle for biopsy forceps



### Rectal Biopsy Forceps

**FI-18-145-38**

Rectal Biopsy Forceps

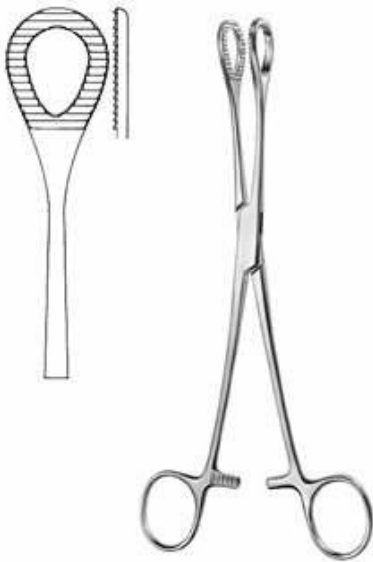

### Heywood-Smith

**FI-18-146-21**

Polypus Grasping Forceps

21 cm

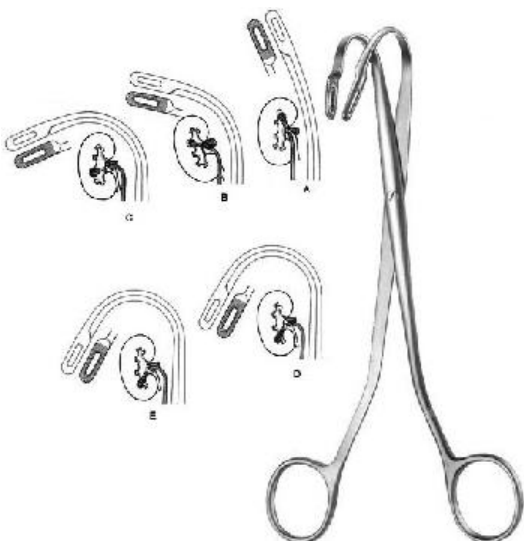

**Randall**

**FI-19-101-23 A**

Kidney Stone Forceps

23 cm Fig. 1 , 21 cm Fig. 2, 21 cm Fig. 3



**Randall**

**FI-19-102-23 A**

Kidney Stone Forceps

23 cm , 24.5 cm

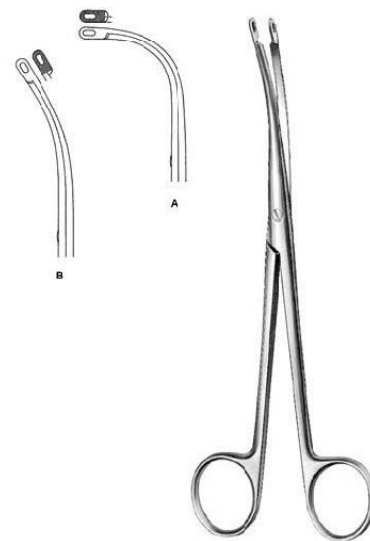

**Heiming**

**FI-19-103-16 A**

Kidney Stone Forceps

16 cm Fig. 1, 17 cm Fig. 2

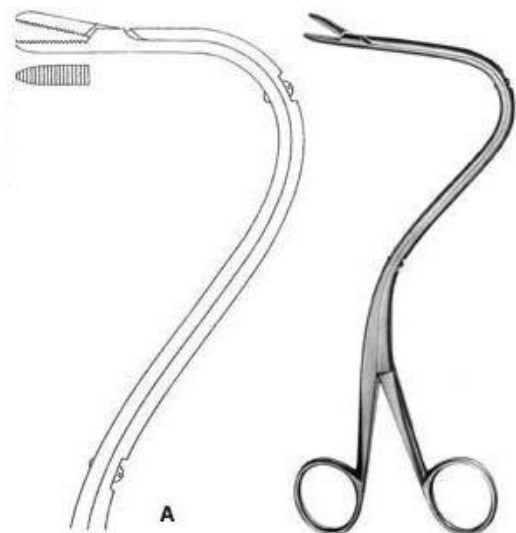

**Elsasser**

**FI-19-104-01 A**

Nephrostomy Forceps

21 cm Fig. 1 , 21 cm Fig. 2

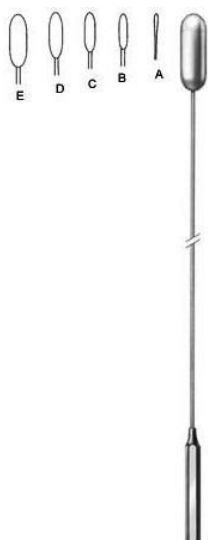

**Bakes**

**FI-19-105-01 A**

Gall Duct Dilator

32 cm

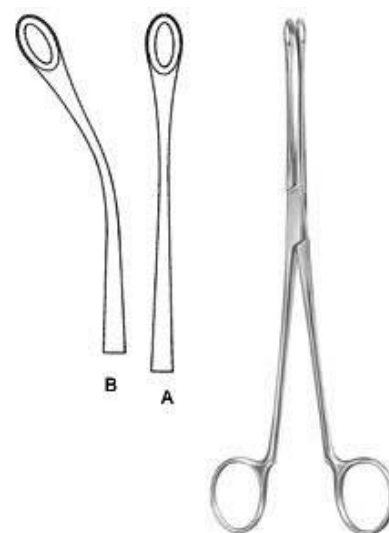

**Blake**

**FI-19-106-20 A**

Gall Stone Forceps

21 cm



**FISKER**  
INSTRUMENTS

## Surgical Instruments

Urology



### Mayo-Blake

FI-19-107-20

Gall Stone Forceps  
21 cm



### Mayo-Blake

FI-19-108-20

Gall Stone Forceps  
21 cm



### Mixer

FI-19-109-22

Gall Stone Forceps  
21.5 cm



### Desjardins

FI-19-110-23 A

Gall Stone Forceps  
23 cm

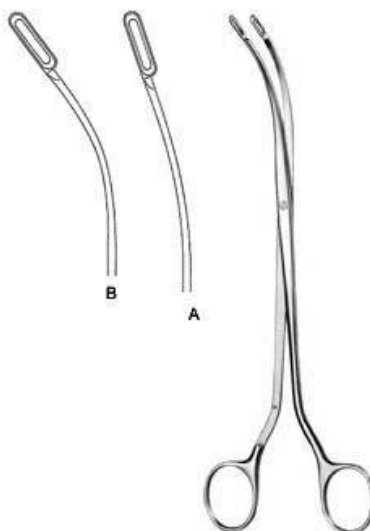

### Desjardins

FI-19-111-24 A

Gall Stone Forceps



### Luer-Korte

FI-19-112-01 A

Gall Stone Scoop

32 cm Fig. 0, 32 cm Fig. 00, 32 cm Fig. 000, 32 cm Fig. 1, 32 cm Fig. 2, 32 cm Fig. 3, 32 cm Fig. 4



**FISKER**  
INSTRUMENTS

## Surgical Instruments

Urology

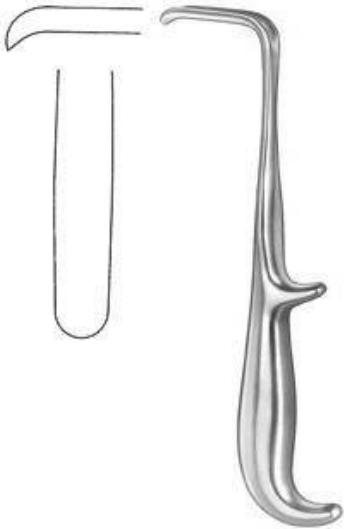

**Young**  
**FI-19-113-21**  
Prostatic Retractor  
21.5 cm



**Young**  
**FI-19-114-22**  
Prostatic Retractor  
20.5 cm

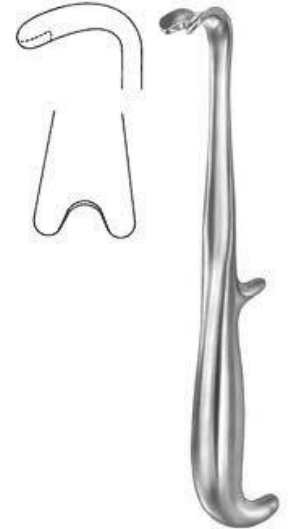

**Young**  
**FI-19-115-21**  
Prostatic Retractor  
22 cm

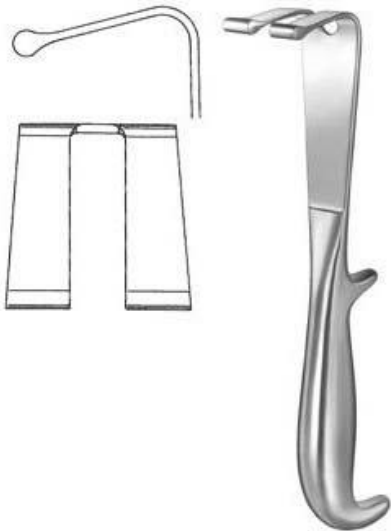

**Young**  
**FI-19-116-22**  
Prostatic Retractor  
21.5 cm

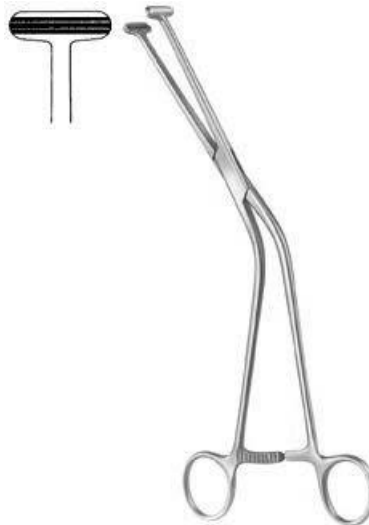

**Millin**  
**FI-19-117-24**  
Capsule Forceps  
24.5 cm

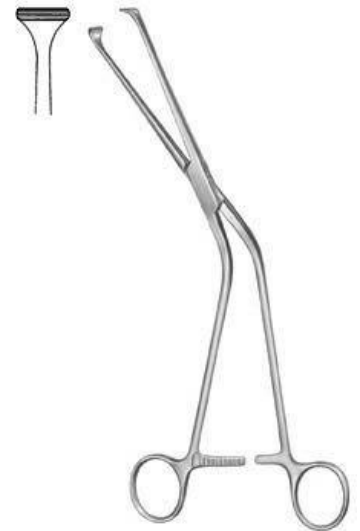

**Millin**  
**FI-19-118-24**  
Capsule Forceps  
22 cm



**FISKER**  
INSTRUMENTS

## Surgical Instruments

Urology



**Millin**

**FI-19-119-23**

Capsule Forceps  
24.5 cm



**Millin**

**FI-19-120-23**

Capsule Forceps  
22 cm

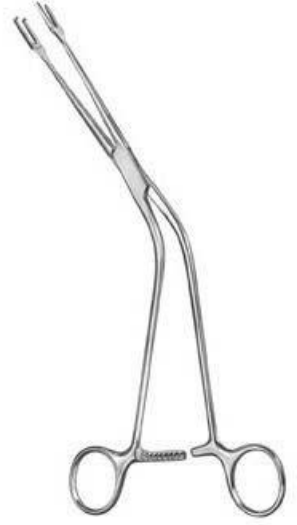
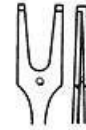

**Millin**

**FI-19-121-24**

Ligature Carrying Forceps  
24.5 cm



**Millin**

**FI-19-122-00**

Bladder Neck Spreader  
29



**Thomson-Walker**

**FI-19-123-00**

Bladder Retractor



**Judd-Masson**

**FI-19-124-00**

Bladder Retractor





**FISKER**  
INSTRUMENTS

## Surgical Instruments

Urology



### Millin

**FI-19-125-00 A**

Bladder Retractor



### Legueu

**FI-19-126-27**

Bladder Spatula  
24 cm , 35 mm

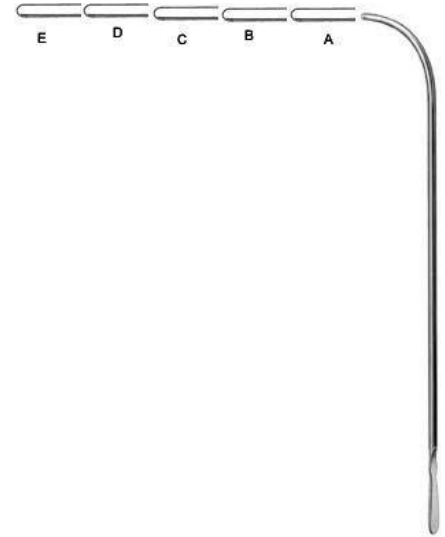

### Van Buren

**FI-19-127-00 A**

Urethral Sound  
27.5 cm

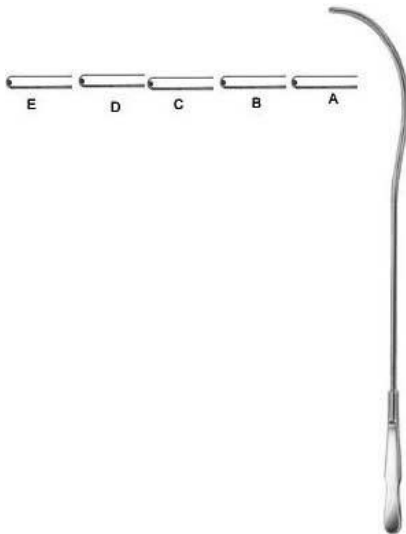

### Guyon

**FI-19-128-10 A**

Urethral Sound  
26 cm



**FISKER**  
INSTRUMENTS

## Surgical Instruments

Gynecology



**Cusco**

**FI-20-101**

Vaginal Speculum  
75 x 32 mm, 85 x 35 mm



**Cusco**

**FI-20-102-01**

Vaginal Speculum  
75 x 18 mm



**Cusco**

**FI-20-103-01**

Vaginal Speculum  
80 x 22 mm, 100 x 25 mm, 105 x 27 mm



**Cusco**

**FI-20-104-01**

Vaginal Speculum  
75 x 34 mm, 85 x 37 mm



**Collin**

**FI-20-105-01**

Vaginal Speculum  
85 x 30 mm, 100 x 35 mm

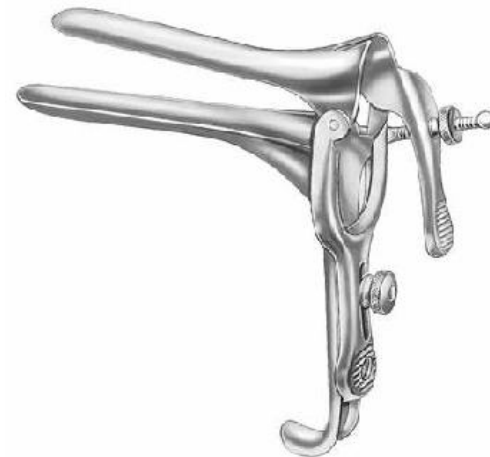

**Pederson**

**FI-20-106-01**

Vaginal Speculum  
75 x 13 mm, 100 x 22 mm



**FISKER**  
INSTRUMENTS

## Surgical Instruments

Gynecology



### Grave

**FI-20-107-01**

Vaginal Speculum

75 x 20 mm, 95 x 35 mm

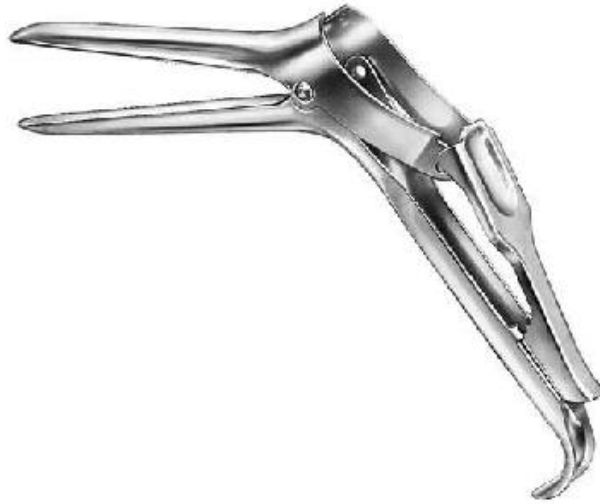

### Semm

**FI-20-108-01**

Vaginal Speculum

100 x 20 mm, 105 x 27 mm



### Sims

**FI-20-109-01**

Vaginal Speculum

65 x 25 mm, 70 x 30 mm



### Kristeller

**FI-20-110-01**

Vaginal Speculum

70 x 27 mm



### Kristeller

**FI-20-111-01**

Vaginal Retractor

75 x 23 mm



### Kristeller

**FI-20-112-01**

Vaginal Speculum

Size 1



**FISKER**  
INSTRUMENTS

## Surgical Instruments

Gynecology



**Kristeller**

**FI-20-113-01**

Vaginal Speculum  
105 x 18 mm



**Kristeller**

**FI-20-114-01**

Vaginal Retractor  
110 x 14 mm



**Kristeller**

**FI-20-115-01**

Vaginal Speculum  
Size 1

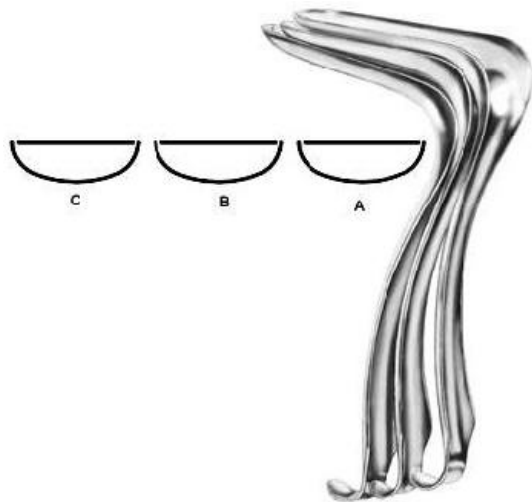

**Kristeller**

**FI-20-116-01**

Vaginal Speculum  
105 x 26 mm

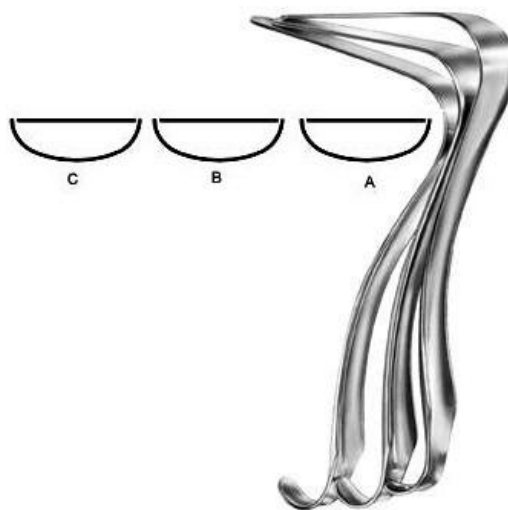

**Kristeller**

**FI-20-117-01**

Vaginal Retractor  
115 x 22 mm, 115 x 23 mm

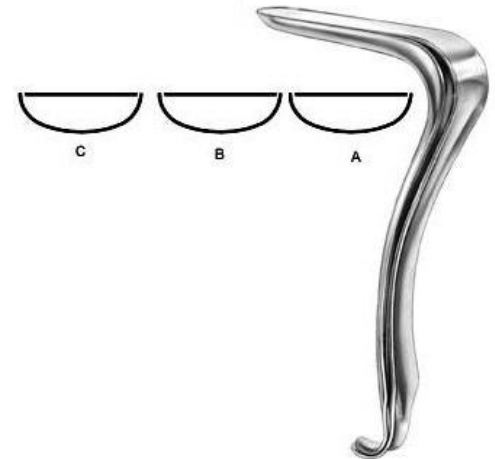

**Kristeller**

**FI-20-118-01**

Vaginal Speculum  
Size 1

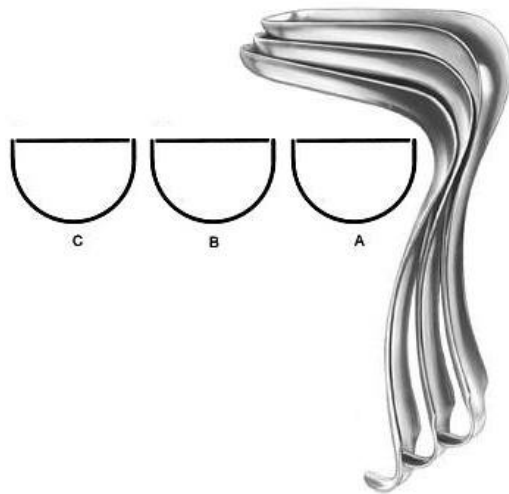

**Kristeller**

**FI-20-119-01**

Vaginal Speculum  
110 x 27 mm

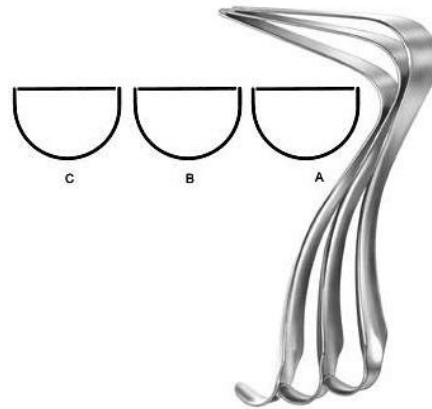

**Kristeller**

**FI-20-120-01**

Vaginal Retractor  
115 x 23 mm

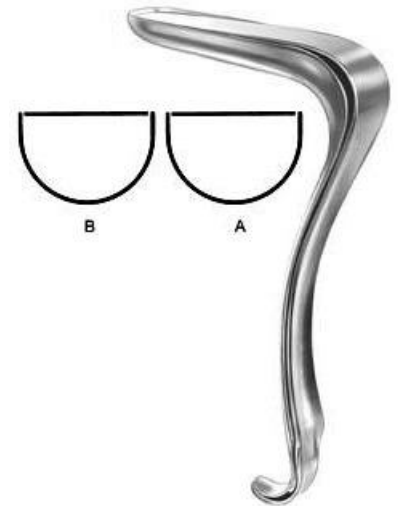

**Kallmorgen**

**FI-20-121-01**

Vaginal Speculum



**Kallmorgen**

**FI-20-122-01**

Vaginal Retractor  
70 x 40 mm Fig. 1, 90 x 40 mm Fig. 2



**Kallmorgen**

**FI-20-123-01**

Vaginal Speculum  
70 x 33 mm, 90 x 33 mm

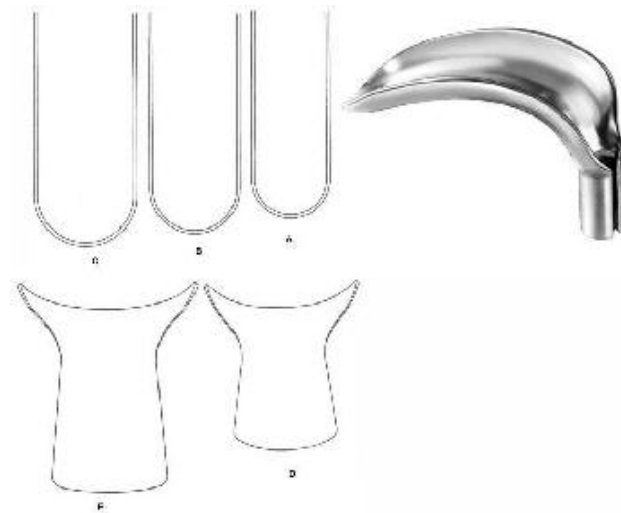

**Scherbak**

**FI-20-125-00**

Vaginal Speculum  
Size 1



**FISKER**  
INSTRUMENTS

## Surgical Instruments

Gynecology



**Auvard**

**FI-20-126-22**

Vaginal Speculum  
80 x 43 mm



**Weissbarth**

**FI-20-127-24**

Vaginal Speculum  
21 cm 80 x 42 mm



**Breisky**

**FI-20-128-20**

Vaginal Speculum  
29 cm 100 x 20 mm, 29 cm 100 x 25 mm



**Kogan**

**FI-20-129-24**

Endocervical Speculum  
25 cm 70 x 30 mm



**Kogan**

**FI-20-130-24**

Endocervical Speculum  
24.5 cm



**Hegar**

**FI-20-131-24**

Uterine Dilator  
18.5 cm 1,0



**FISKER**  
INSTRUMENTS

## Surgical Instruments

Gynecology



### Hegar

**FI-20-132-02**

Uterine Dilator  
20 cm 1,0



### Hank

**FI-20-133-10**

Uterine Dilator  
26.5 cm Fig. 9/10



### Sims

**FI-20-134-32**

Uterine Sound  
33 cm



### Valleix

**FI-20-135-25**

Uterine Sound  
29.5 cm



### Braun

**FI-20-136-26**

Uterine Depressor  
27.5 cm



### Schroder

**FI-20-137-25**

Uterine Tenaculum Forceps  
25.5 cm



**Braun**

**FI-20-138-25**

Uterine Tenaculum Forceps  
26 cm



**Duplay**

**FI-20-139-28**

Uterine Tenaculum Forceps  
25.5 cm



**Beacham**

**FI-20-140-26**

Amniotome  
26 cm



**Skene**

**FI-20-141-24**

Uterine Tenaculum Forceps  
24 cm

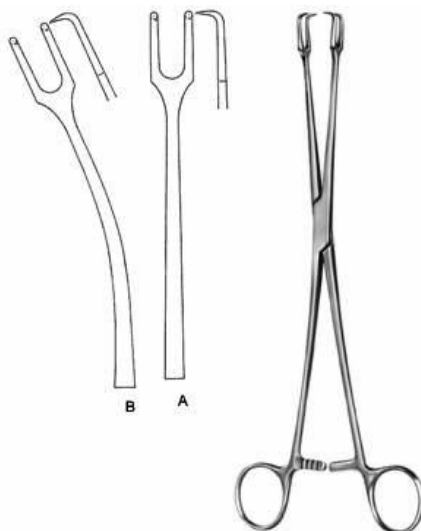

**Schroder**

**FI-20-142-24**

Uterine Tenaculum Forceps  
25 cm



**Teale**

**FI-20-143-23**

Uterine Tenaculum Forceps  
23.5 cm





**FISKER**  
INSTRUMENTS

## Surgical Instruments

Gynecology

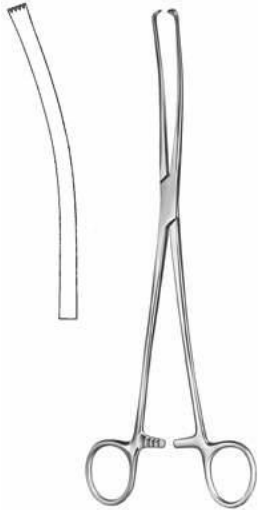

**Iowa**

**FI-20-144-26**

Uterine Tenaculum Forceps  
26 cm



**Museux**

**FI-20-145-24**

Uterine Tenaculum Forceps  
24 cm



**Jacobs**

**FI-20-146-21**

Uterine Tenaculum Forceps  
21 cm



**Uterine Tenaculum Forcep**

**FI-20-147-26**

Uterine Tenaculum Forcep  
26.5 cm



**Braun**

**FI-20-148-16**

Uterine Tenaculum Forceps  
16 cm

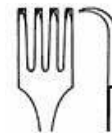

**Czerny**

**FI-20-149-21**

Uterine Tenaculum Forceps  
21 cm



**FISKER**  
INSTRUMENTS

## Surgical Instruments

Gynecology



**Kelly**

**FI-20-150-32**

Uterine Polypus Forceps  
32 cm



**Noto**

**FI-20-151-27**

Uterine Polypus Forceps  
27 cm

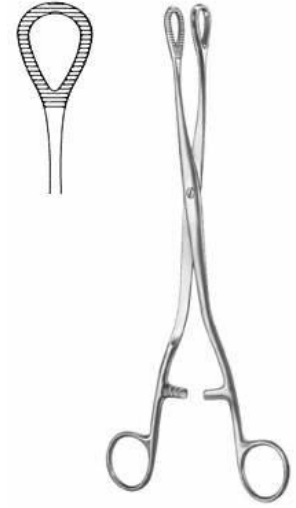

**Heywood-Smith**

**FI-20-152-25**

Uterine Polypus Forceps  
25 cm



**Doyen**

**FI-20-153-17**

Myoma Screw  
17 cm



**Doyen**

**FI-20-154-17**

Myoma Screw  
14.5 cm



**Segond**

**FI-20-155-27**

Myoma Knife  
28 cm



**FISKER**  
INSTRUMENTS

## Surgical Instruments

Gynecology

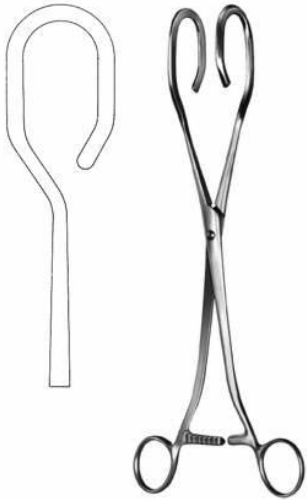

**Dartigues**

**FI-20-156-27**

Uterine Seizing Forceps

28 cm



**Somer**

**FI-20-157-27**

Uterine Seizing Forceps

22.5 cm



**Collin**

**FI-20-158-25**

Uterine Seizing Forceps jaw 40 mm wide

26 cm



**Ayre**

**FI-20-159-23**

Conization Knife cutting edge 3,6 mm wide

23.5 cm



**Emmett**

**FI-20-160-03**

Fistula Hook

22 cm Fig.3



**Simon**

**FI-20-161-22**

Fistula Hook

21.5 cm



**FISKER**  
INSTRUMENTS

## Surgical Instruments

Gynecology



**Simon**

**FI-20-162-22**

Fistula Hook  
21.5 cm



**Novak**

**FI-20-163-23**

Suction Curette 4 mm ?  
24.5 cm



**Kevorkian**

**FI-20-164-23**

Uterine Biopsy Curette 6,0 mm ?  
30 cm



**Munchen**

**FI-20-165-27**

Uterine Biopsy Curette 4,8 mm ?  
27 cm



**Gellhorn**

**FI-20-166-23**

Uterine Biopsy Forceps jaw 8,6 mm wide  
24 cm



**Faure**

**FI-20-167-21**

Faure Uterine Biopsy Forceps  
21 cm



**FISKER**  
INSTRUMENTS

## Surgical Instruments

Gynecology

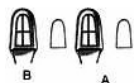

**Schubert**  
**FI-20-168-21**

Uterine Biopsy Forceps jaw 4,8 mm wide  
21.5 cm, 28 cm



**Thoms-Gaylor**  
**FI-20-169-22**

Uterine Biopsy Forceps jaw 5,6 mm ?  
21 cm, 23.5 cm

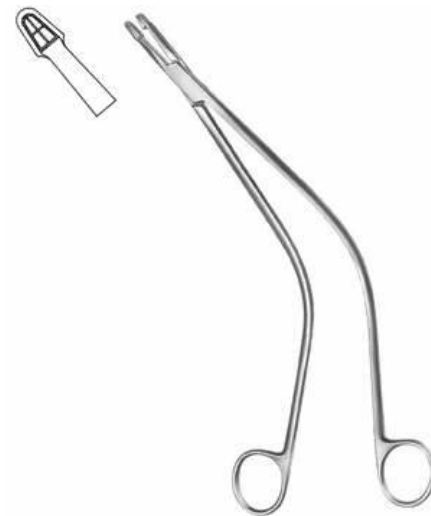

**Schubert**  
**FI-20-170-26**

Schubert Uterine Biopsy Forceps  
25.5 cm

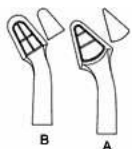

**Van Doren**  
**FI-20-171-24**

Uterine Biopsy Forceps jaw 4,9 mm wide  
27 cm, 25.5 cm



**Alexander**  
**FI-20-172-28**

Uterine Biopsy Forceps jaw 5,1 mm wide  
28 cm



**Kevorkian**  
**FI-20-173-32**

Uterine Biopsy Forceps  
25 cm



**FISKER**  
INSTRUMENTS

# Surgical Instruments

Gynecology

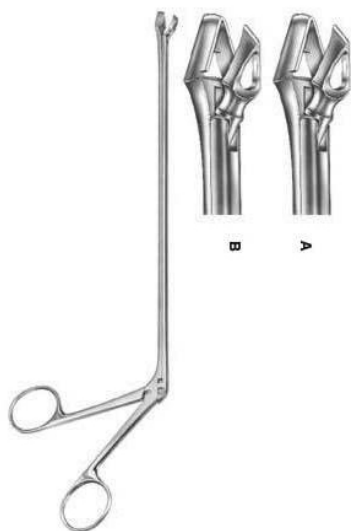

**Schumacher**

**FI-20-174-01**

Uterine Biopsy Forceps jaw 4,6 / 5,4 mm wide  
24 cm



**Schumacher**

**FI-20-175-00**

Uterine Biopsy Forceps  
25 cm



**IUP Grasping Forceps 3 Mm ?**

**FI-20-176-22**

IUP Grasping Forceps 3 mm ?  
22 cm

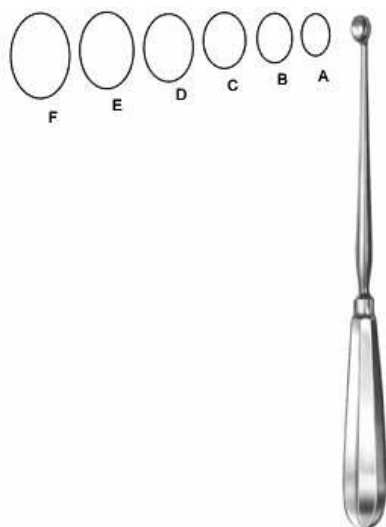

**Simon**

**FI-20-177-01**

Uterine Scoop  
24.5 cm 9,8 x 8,6 mm, 24.5 cm 11,6 x 8,3 mm



**Simon**

**FI-20-178-01**

Uterine Scoop  
30 cm 9,8 x 8,6 mm, 30 cm 11,6 x 8,3 mm



**Recamier**

**FI-20-179-05**

Uterine Curette  
31 cm Fig. 00 5 mm, 31 cm Fig. 0 6 mm



**FISKER**  
INSTRUMENTS

## Surgical Instruments

Gynecology



### Recamier

**FI-20-180-05**

Uterine Curette

31 cm Fig. 00 5 mm, 31 cm Fig. 0 6 mm



### Sims

**FI-20-181-05**

Uterine Curette

31 cm Fig. 00 5 mm, 31 cm Fig. 0 6 mm

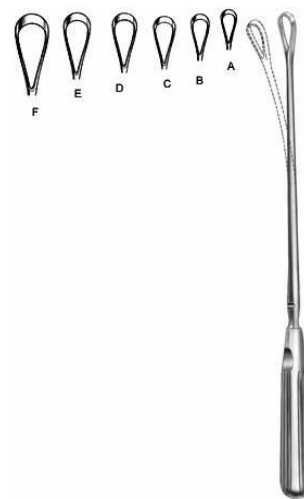

### Sims

**FI-20-182-05**

Uterine Curette

31 cm Fig. 00 5 mm, 31 cm Fig. 0 6 mm



### Suction Curette

**FI-0-183-03**

Suction Curette

29 cm 3,0 mm ?, 29 cm 4,5 mm ?, 29 cm 6,0 mm ?



**FISKER**  
INSTRUMENTS

## Surgical Instruments

Obstetrics



### Martin

**FI-21-101-34**

Pelvimeter cm, inch scale  
34 cm



### Nagele

**FI-5-102-36**

Obstetrical Forceps  
35 cm, 40.5 cm



### Simpson

**FI-5-103-30**

Obstetrical Forceps  
31 cm



### Wrigley

**FI-5-104-28**

Obstetrical Forceps  
28 cm



### Simpson

**FI-21-105-36**

Obstetrical Forceps  
36.5 cm



### Kielland

**FI-21-106-41**

Obstetrical Forceps  
42 cm



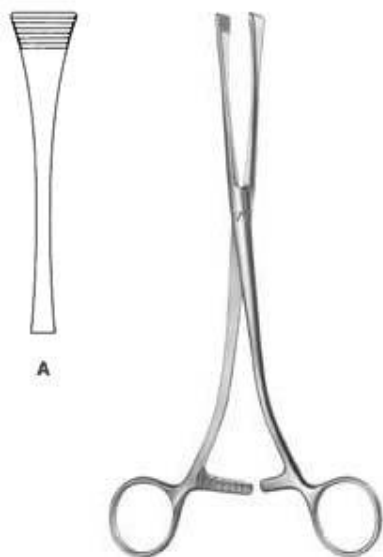

**Green-Armytage**

**FI-21-107-21**

Uterine Clamp

21 cm



**Sellheim**

**FI-21-108-28**

Obstetrical Lever

32 cm

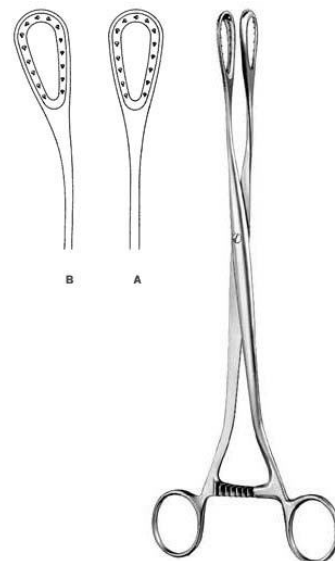

**Sanger**

**FI-21-109-27**

Placenta and Ovum Forceps

27.5 cm, 27 cm

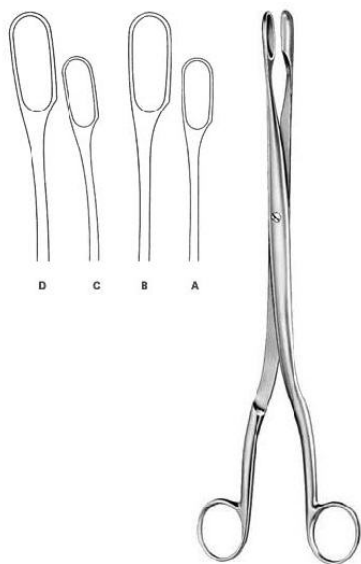

**Winter**

**FI-21-110-01**

Placenta and Ovum Forceps

28 cm Fig. 1, 28 cm Fig. 2

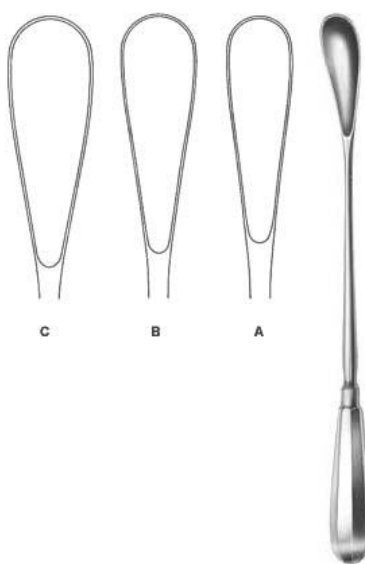

**Cuzzi**

**FI-21-111-01**

Placenta Scoop

30 cm 14,5 mm, 30 cm 18 mm

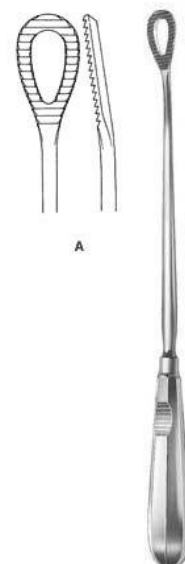

**Pestalozza**

**FI-21-112-30**

Placenta Scoop

30 cm



**FISKER**  
INSTRUMENTS

## Surgical Instruments

Obstetrics

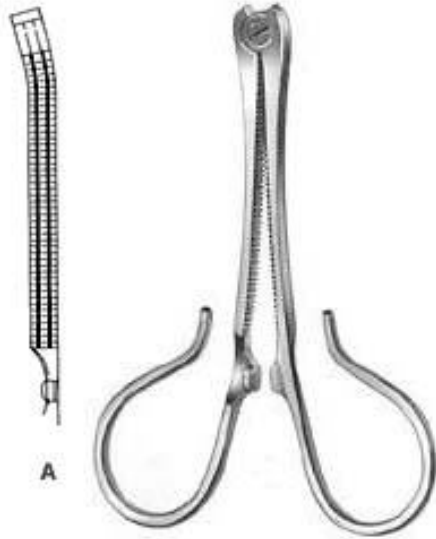

**Kane**

**FI-21-113-08**

Umbilical Cord Clamp

8.5 cm



**Collin**

**FI-21-114-09**

Umbilical Cord Clamp

8.5 cm



**FISKER**  
INSTRUMENTS

## Surgical Instruments

Sterilization



### Irrigator

**FI-23-101-10**

Sterilization  
Size 1



### Round Bowl

**FI-23-102-16**

Sterilization  
220 mm x 70 mm, 400 mm x 150 mm



### Round Bowl

**FI-23-103-33**

Sterilization  
? x h 6,00 l



### Flat Dish

**FI-23-104-11**

Sterilization  
? x h 0,20 l



### Lid Only

**FI-23-105-11**

Sterilization  
Size 1



### Stainless Steel

**FI-23-106-04**

Sterilization  
? x h 0,30 l



**FISKER**  
INSTRUMENTS

## Surgical Instruments

Sterilization



### Round Dish

**FI-23-107-11**

Sterilization

? x h 0,30 l, ? 128 x 38 mm 0,40 l



### Flat Dish

**FI-23-108-11**

Sterilization

? x h 0,15 l



### Measurer

**FI-23-109-01**

Graduated inside

100cc = 0,1 l



### Measurer

**FI-23-110-02**

Graduated Inside

0,25 l, 0,50 l



### Petri Dish

**FI-23-111-10**

with Lid ? x h



### Petri Dish

**FI-23-112-09**

without lid ? x h

Size 1



**FISKER**  
INSTRUMENTS

## Surgical Instruments

Sterilization



### Lid For Petri Dishes

**FI-23-113-10**

Sterilization  
Size 1



### Universal Tray

**FI-23-114-23**

Sterilization  
l x b x h



### Instrument Tray

**FI-23-115-21**

Sterilization  
l x b x h



### Universal Tray

**FI-23-116-23**

Sterilization  
l x b x h



### Round Bowl

**FI-23-117-22**

Sterilization  
? x h



### Metal Jar

**FI-23-118-30**

Sterilization  
? 30mm x 90 mm, ? 50mm x 100 mm



**FISKER**  
INSTRUMENTS

## Surgical Instruments

Sterilization



### Instrument Box

**FI-23-119-16**

lid with knob  
l x b x h



### Instrument Box

**FI-23-120-16**

lid with knob  
l x b x h



### Instrument Box

**FI-23-121-20**

Sterilization  
l x b x h



### Round Metal Box

**FI-23-122-06**

Sterilization  
? 75 mm x 75 mm, ? 100 mm x 60 mm



### Medicine Cup Graduated Inside

**FI-23-123-25**

Sterilization  
25 cm



### Medicine Cup Graduated Inside

**FI-23-124-50**

Sterilization  
50 cm



**FISKER**  
INSTRUMENTS

## Surgical Instruments

Sterilization



**Tablet Tray**

**FI-23-125-75**

Sterilization  
? 75 mm x 12 mm



**Metal Cup**

**FI-23-126-90**

Sterilization  
? 90 mm x 90 mm



**Denture Cup**

**FI-23-127-75**

Sterilization  
? 75 mm x 50 mm



**Insert For Cup**

**FI-23-128-75**

Sterilization  
? 73 mm x 75 mm



**Kidney Dish**

**FI-23-129-17**

Kidney Dish  
l x b x h



**Placenta Pan**

**FI-23-130-36**

Sterilization  
Size 1



**FISKER**  
INSTRUMENTS

## Surgical Instruments

Sterilization



**Waste Cotton Collector**

**FI-23-131-01**

Sterilization

? 50 mm x 75 mm



**Spirit Lamp**

**FI-23-132-07**

Sterilization

120 cm





**FISKER**  
INSTRUMENTS

## Surgical Instruments

Bone Surgery



**Charrière**

**FI-7-102-35**

Amputation Saw

35 cm



**Langenbeck**

**FI-7-103-23**

Amputation Saw

24.5 cm



**Charrière**

**FI-7-104-27**

Amputation Saw

26.5 cm



**Reamer**

**FI-7-105-14**

Reamer

13.5 cm



**Perthes**

**FI-7-106-18**

Reamer

18 cm

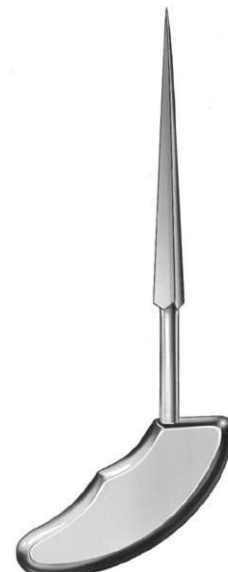

**Perthes**

**FI-7-107-21**

Reamer

21.5 cm



**FISKER**  
INSTRUMENTS

## Surgical Instruments

Bone Surgery



**Reamer**

**FI-7-108-14**

Reamer  
14 cm



**Flat Trephine**

**FI-7-111-18**

Flat Trephine

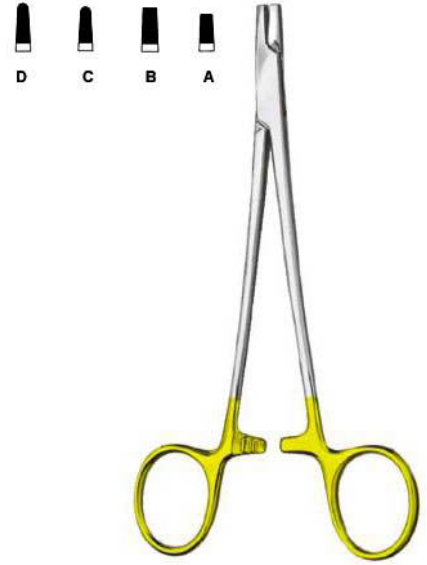

**Wire Twisting Forceps**

**FI-7-112-01**

Wire Twisting Forceps  
15.5 cm, 18 cm, 20 cm

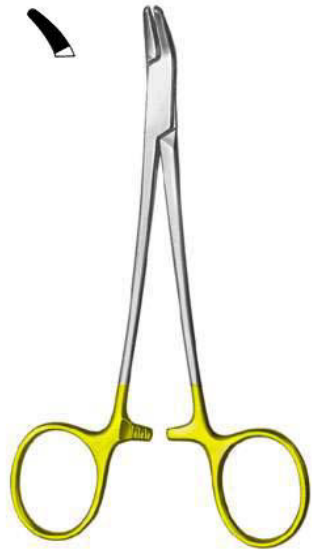

**Wire Twisting Forceps**

**FI-7-113-15**

Wire Twisting Forceps  
15.5 cm



**Flat Nose Plier**

**FI-7-114-17**

Flat Nose Plier  
18.5 cm



**Wire Twisting Forceps**

**FI-7-115-18**

Wire Twisting Forceps  
19 cm



**FISKER**  
INSTRUMENTS

## Surgical Instruments

Bone Surgery



**Combi-Flat Nose Plier**

**FI-7-116-15**

Combi-Flat Nose Plier  
15 cm



**Flat Nose Plier**

**FI-7-117-01**

Flat Nose Plier  
18 cm

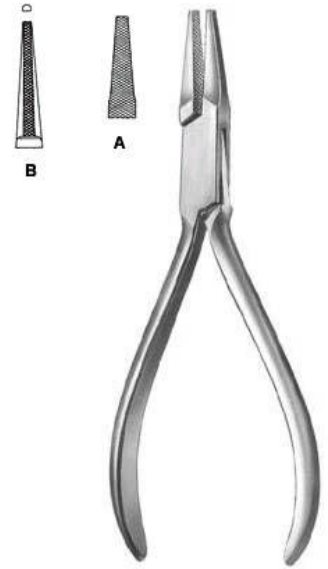

**Flat Nose Plier**

**FI-7-118-14**

Flat Nose Plier  
13.5 cm



**Hackstock**

**FI-7-119-16**

Flat Nose Plier  
16 cm



**Flat Nose Plier**

**FI-7-120-01**

Flat Nose Plier  
17.5 cm



**Wire Cutting Pliers**

**FI-7-121-18**

Wire Cutting Pliers  
18.5 cm



**FISKER**  
INSTRUMENTS

## Surgical Instruments

Bone Surgery



**Wire Cutting Pliers**

**FI-7-122-15**

Wire Cutting Pliers  
15 cm



**Wire Cutting Pliers**

**FI-7-123-18**

Wire Cutting Pliers  
17.5 cm

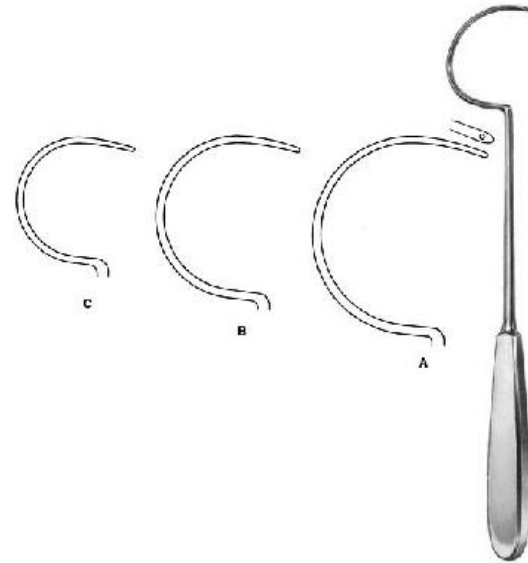

**Demel**

**FI-7-124-18**

Wire Guide  
28 cm Fig. 3 , 29 cm Fig. 2 , 31 cm Fig. 1

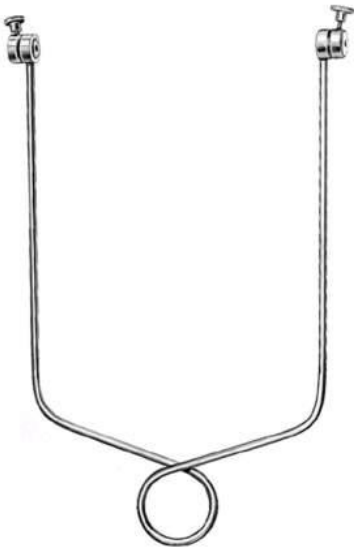

**Bohler**

**FI-7-125-15**

Extension Bow



**Kirschner**

**FI-7-126-01**

Extension Bow  
18.5 cm , 26.5 cm



**Traction Hook For Extention Bows**

**FI-7-127-06**

Traction Hook for Extention Bows



**FISKER**  
INSTRUMENTS

## Surgical Instruments

Bone Surgery



**Kirschner**  
**FI-7-128-06**  
Wire Drill  
6 cm, 12 cm



**Kirschner**  
**FI-7-129-06**  
Wire Drill  
14 cm, 16 cm



**Kirschner**  
**FI-7-130-10**  
Wire Drill  
31 cm



**Kirschner**  
**FI-7-131-10**  
Wire Drill  
12 cm, 16 cm, 18 cm



**Kirschner**  
**FI-7-132-10**  
Wire Drill  
31 cm



**Buckley**  
**FI-7-133-02**  
Chisel  
16 cm



**FISKER**  
INSTRUMENTS

## Surgical Instruments

Bone Surgery



### **Buckley**

**FI-7-134-02**

Gouge  
16 cm



### **Stout**

**FI-7-135-03**

Bone Chisel  
21 cm



### **Bone Chisel**

**FI-7-112-01**

Bone Chisel  
18 cm



### **Bone Chisel**

**FI-7-137-04**

Bone Chisel  
18 cm



### **Bone Chisel**

**FI-138-04**

Bone Chisel  
17 cm



### **Bone Chisel**

**FI-7-139-04**

Bone Chisel  
17 cm



**FISKER**  
INSTRUMENTS

# Surgical Instruments

Bone Surgery

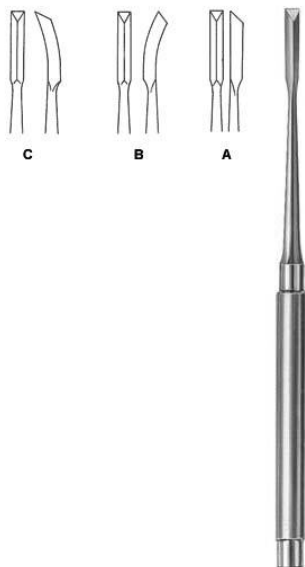

**Gardner**  
**FI-7-112-01**  
Bone Chisel  
17 cm 4mm



**Snyder-O.S.U.**  
**FI-7-141-03**  
Bone Chisel  
16.5 cm 3mm , 16.5 cm 5.5mm



**O.S.U.**  
**FI-7-142-01**  
one Chisel  
17 cm 7mm



**O.S.U.**  
**FI-7-143-01**  
One Chisel  
17 cm 9mm



**Osteotome**  
**FI-7-144-08**  
Osteotome  
13.5 cm 8mm , 13.5 cm 10mm , 13.5 cm 12mm ,  
13.5 cm 14mm , 13.5 cm 16mm



**Chisel**  
**FI-7-145-08**  
Chisel  
13.5 cm 8mm , 13.5 cm 10mm , 13.5 cm 12mm ,  
13.5 cm 14mm , 13.5 cm 16mm



**FISKER**  
INSTRUMENTS

# Surgical Instruments

Bone Surgery



## Gouge

**FI-7-146-08**

Gouge

13.5 cm 8mm , 13.5 cm 10mm , 13.5 cm 12mm ,  
13.5 cm 14mm , 13.5 cm 16mm



## Partsch

**FI-7-147-02**

Chisel

13.5 cm 2mm, 13.5 cm 3mm , 13.5 cm 4mm , 13.5  
cm 5mm , 13.5 cm 6mm , 17 cm 2mm , 17 cm  
3mm , 17 cm 4mm , 17 cm 5mm , 17 cm 6mm



## Partsch

**FI-7-148-02**

Gouge

13.5 cm 2mm, 13.5 cm 3mm , 17 cm 2mm , 17 cm  
3mm

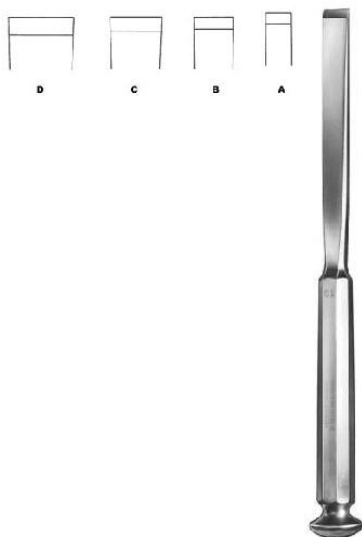

## Stille

**FI--7-149**

Chisel

20 cm 10mm , 20 cm 15mm , 20 cm 20mm , 20  
cm 25mm



## Stille

**FI-7-150**

Osteotome

20 cm 10mm , 20 cm 15mm , 20 cm 20mm , 20  
cm 25mm



## Stille

**FI-7-151-10**

Gouges

20 cm 10mm , 20 cm 15mm , 20 cm 20mm , 20  
cm 25mm





**FISKER**  
INSTRUMENTS

## Surgical Instruments

Bone Surgery



### Lambotte, Mini

**FI-7-152-02**

Osteotome

12.5 cm 2mm , 12.5 cm 3mm , 12.5 cm 4mm ,  
12.5 cm 6mm



### Lambotte

**FI-7-153-15**

Osteotome

24 cm 15mm , 24 cm 20mm , 24 cm 25mm , 24  
cm 30mm



### Lambotte

**FI-7-154-15**

Osteotome

24 cm 15mm , 24 cm 20mm , 24 cm 25mm , 24  
cm 30mm



### Smith-Petersen

**FI-7-155-06**

Osteotome

20.5 cm 6mm , 20.5 cm 9mm , 20.5 cm 13mm



### Smith-Petersen

**FI-7-156-06**

Osteotome

20.5 cm 6mm , 20.5 cm 9mm , 20.5 cm 13mm ,  
20.5 cm 16mm , 20.5 cm 19mm



### Smith-Petersen

**FI-7-157-09**

Gouge

20.5 cm 9mm , 20.5 cm 14mm , 20.5 cm 19mm ,  
20.5 cm 25mm



**FISKER**  
INSTRUMENTS

# Surgical Instruments

Bone Surgery



**Smith-Petersen**

**FI-7-158-09**

Gouge

20.5 cm 9mm , 20.5 cm 14mm , 20.5 cm 19mm



**Hoke**

**FI-7-159-03**

Osteotome

17 cm 3mm , 17 cm 5mm , 17 cm 6mm , 17 cm 8mm

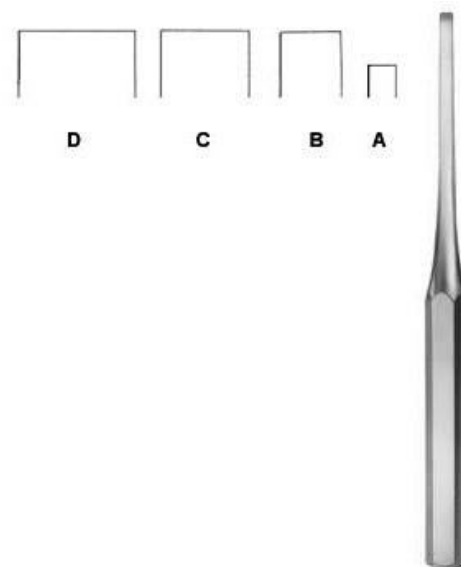

**Hibbs**

**FI-7-151-10**

Osteotome

24.5 cm 6mm , 24.5 cm 13mm , 24.5 cm 19mm

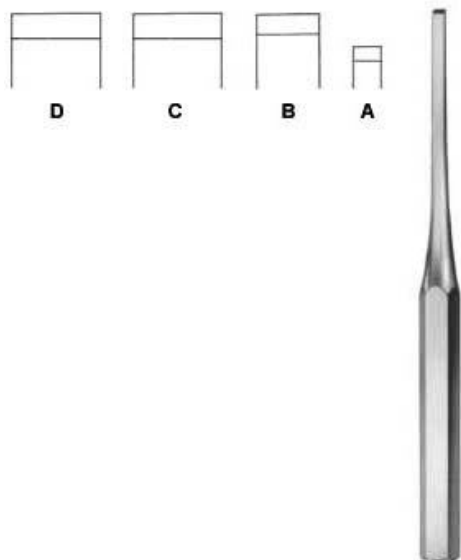

**Hibbs**

**FI-7-161-06**

Chisel

24.5 cm 6mm , 24.5 cm 13mm , 24.5 cm 19mm

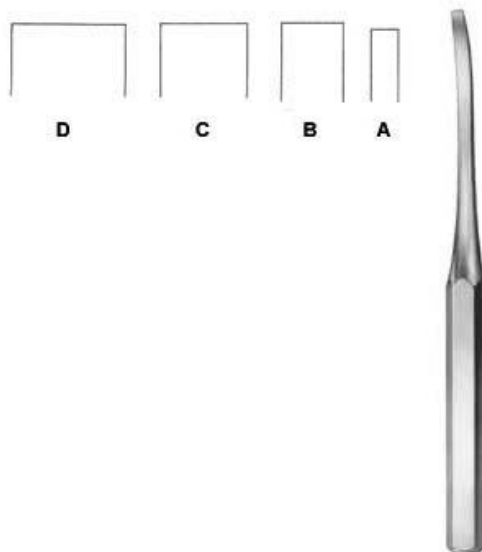

**Hibbs**

**FI-7-162-06**

Osteotome

24.5 cm 6mm , 24.5 cm 13mm , 24.5 cm 19mm

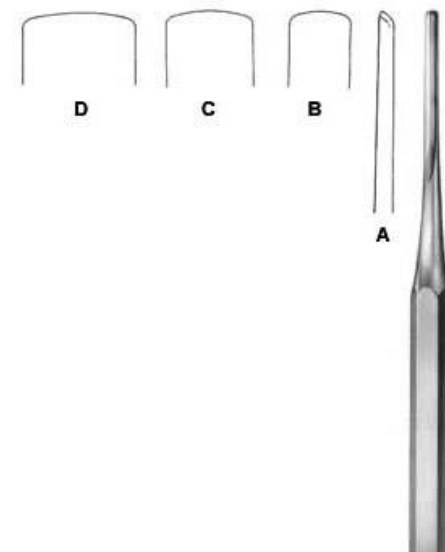

**Hibbs**

**FI-7-163-06**

Hibbs

24.5 cm 6mm , 24.5 cm 13mm , 24.5 cm 19mm



**FISKER**  
INSTRUMENTS

# Surgical Instruments

Bone Surgery



**Hibbs**

**FI-7-164-06**

Gouge

24.5 cm 6mm , 24.5 cm 13mm , 24.5 cm 19mm

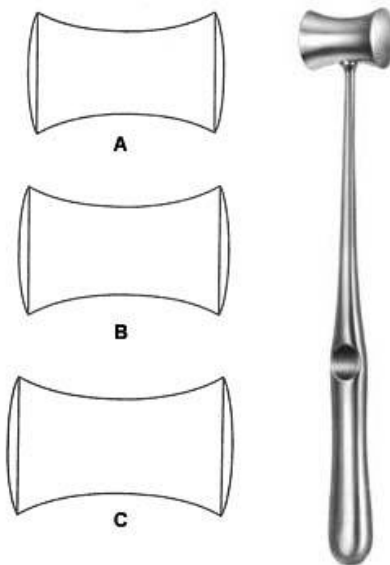

**Williger**

**FI-7-165-01**

Mallet

24 cm

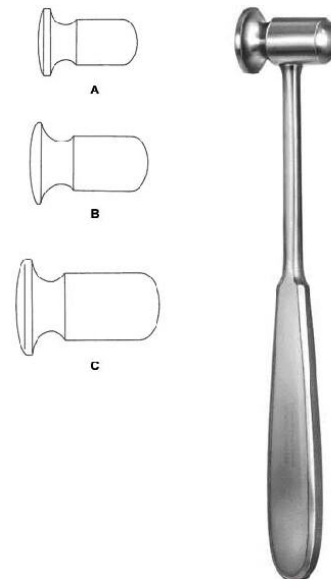

**Doyen**

**FI-7-166-01**

Mallet

20.5 cm, 21 cm, 21.5 cm



**Collin**

**FI-7-151-10**

Mallet

20 cm

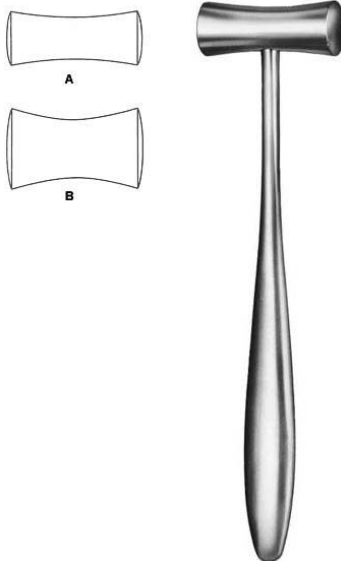

**Lucae**

**FI-7-168-01**

Mallet

19.5 cm



**Cottle**

**FI-7-169-19**

Mallet

19 cm



**FISKER**  
INSTRUMENTS

## Surgical Instruments

Bone Surgery



**Williger**

**FI-7-170-01**

Mallet  
16.5 cm



**Mead**

**FI-7-171-17**

Mallet  
19 cm



**Partsch**

**FI-7-172-18**

Mallet  
19 cm

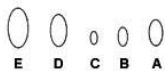

**Schede**

**FI-7-173-01**

Bone Curette Fig. 0 to 4  
17 cm



**Kahre-Williger**

**FI-7-201-04**

Periosteal Elevator  
4 mm, 5 mm, 7 mm



**Periosteal Elevator**

**FI-7-202-06**

Periosteal Elevator  
17 cm 6mm , 17 cm 8mm



**FISKER**  
INSTRUMENTS

# Surgical Instruments

Bone Surgery

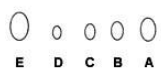

## Volkmann

**FI-7-174-01**

Bone Curette

17 cm Fig. 0, 17 cm Fig. 00, 17 cm Fig. 000, 17 cm Fig. 1, 17 cm Fig. 2, 17.5 cm Fig. 3, 17.5 cm Fig. 4



## Doyen

**FI-7-203-17**

Rib Raspatory

17.5 cm

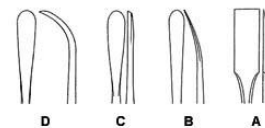

## West

**FI-7-204-19**

Periosteal Elevator, double-ended

17 cm, 17.5 cm



## Bruns

**FI-7-175-01**

Bone Curette

17 cm Fig. 0, 17 cm Fig. 00, 17 cm Fig. 000, 17 cm Fig. 1, 17 cm Fig. 2, 17 cm Fig. 3, 17 cm Fig. 4

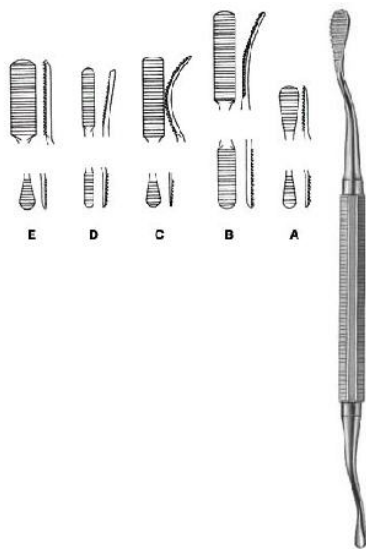

## Miller-Colburn

**FI-7-209-01**

Bone File

18 cm Fig. 1, 18 cm Fig. 2, 18 cm Fig. 3, 18 cm Fig. 4, 18 cm Fig. 5



## Spratt

**FI-7-175-01**

Bone Curette

17 cm Fig. 0, 17 cm Fig. 00, 17 cm Fig. 000, 17 cm Fig. 0000, 17 cm Fig. 1, 17 cm Fig. 2, 17 cm Fig. 3, 17 cm Fig. 4, 17 cm Fig. 5



**FISKER**  
INSTRUMENTS

# Surgical Instruments

Bone Surgery

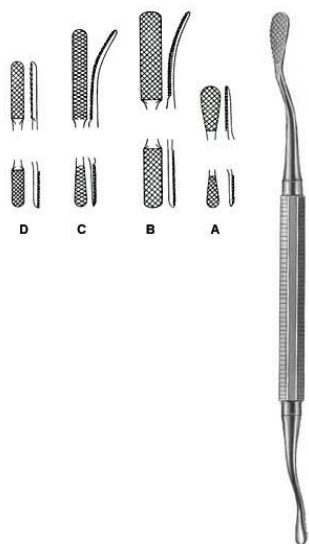

## Miller-Colburn

**FI-7-210-01**

Bone File

18 cm Fig. 1, 18 cm Fig. 2, 18 cm Fig. 3, 18 cm Fig. 4



## Langenbeck

**FI-7-211-20**

Elevator



## Bruns

**FI-7-177-01**

Bone Curette

23 cm Fig. 0, 23 cm Fig. 00, 23 cm Fig. 000, 23 cm Fig. 1, 23 cm Fig. 2, 23 cm Fig. 3

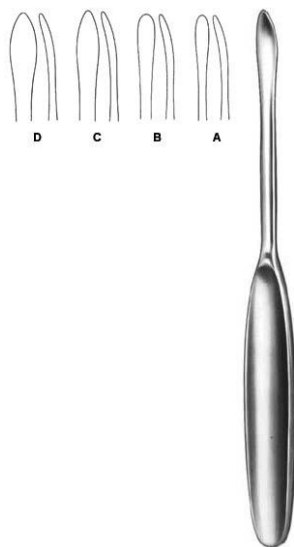

## Martin-Langenbeck

**FI-7-212-01**

Elevator

17 cm 5mm, 17 cm 7mm, 17 cm 8mm



## Scoville

**FI-7-178-25**

Bone Curette

25 cm



## Vickers

**FI-7-213-17**

Elevator

17 cm



**FISKER**  
INSTRUMENTS

# Surgical Instruments

Bone Surgery



**Vickers**  
**FI-7-214-17**  
Dissector  
17 cm

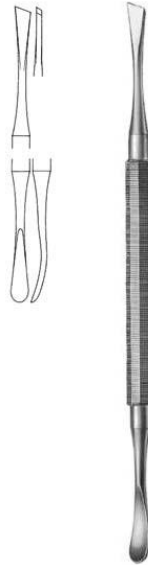

**Simon**  
**FI-7-179-01**  
Bone Curette  
25 cm Fig. 1, 25 cm Fig. 2, 25 cm Fig. 3, 25 cm Fig. 4, 25 cm Fig. 5



**Williger**  
**FI-7-215-17**  
Elevator  
16.5 cm 5.5mm



**Modell USA**  
**FI-7-180-01**  
Bone Curette  
16 cm Fig. 1, 16 cm Fig. 2, 16 cm Fig. 3, 16 cm Fig. 4



**Williger**  
**FI-7-216-16**  
Elevator  
16.5 cm 5.5mm



**Mead**  
**FI-7-217-17**  
Mallet  
19 cm



**FISKER**  
INSTRUMENTS

# Surgical Instruments

Bone Surgery



## Periosteal Elevator

**FI-7-218-18**

Periosteal Elevator



## Hohmann

**FI-7-219-43**

Bone Lever

23.5 cm

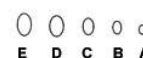

## Modell USA

**FI-7-181-01**

Bone Curette

15.5 cm Fig. 1 , 15.5 cm Fig. 2 , 15.5 cm Fig. 3 ,  
15.5 cm Fig. 4



## Lempert

**FI-7-220-19**

Bone Rongeur

19 cm



## Modell USA

**FI-7-182-01**

Bone Curette

15.5 cm Fig. 1 , 15.5 cm Fig. 2 , 15.5 cm Fig. 3 ,  
15.5 cm Fig. 4



## Luer

**FI-7-221-17**

Bone Rongeur

18 cm, 18.5 cm





**Zaufal-Jansen**  
**FI-7-222-18**  
Bone Rongeur  
18 cm



**Halle**  
**FI-7-183-01**  
Bone Curette  
21 cm Fig. 1 , 21 cm Fig. 2, 21 cm Fig. 3

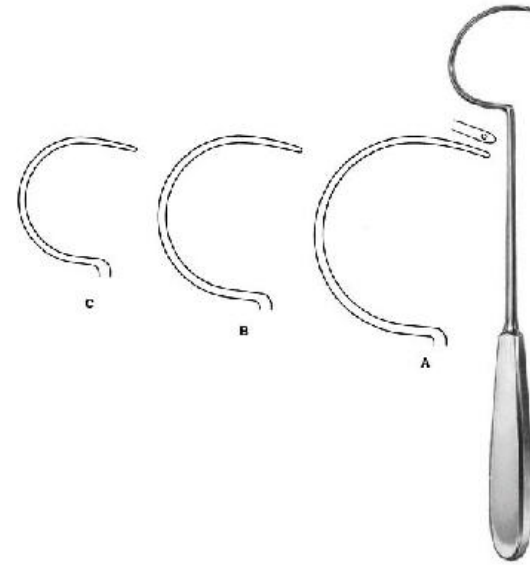

**Demel**  
**FI-7-124-01**  
Wire Guide  
31 cm Fig. 1



**Volkmann**  
**FI-7-184-01**  
Bone Curette, double-ended  
12.5 cm, 14.5 cm , 17 cm



**Volkmann**  
**FI-7-185-13**  
Bone Curette, double-ended  
13 cm , 16 cm



**Bone Curette**  
**FI-7-186-21**  
Bone Curette, double-ended  
21 cm



**FISKER**  
INSTRUMENTS

# Surgical Instruments

Bone Surgery



**Williger**  
**FI-7-187-00**

Bone Curette, double-ended  
13.5 cm Fig. 00/0 , 13.5 cm Fig. 0/1 , 13.5 cm Fig. 1/2



**Hemingway**  
**FI-7-189-11**

Bone Curette, double-ended  
18 cm



**Hemingway**  
**FI-7-190-00**

Bone Curette, double-ended  
18.5 cm



**Bone Curette**  
**FI-7-191-01**

Bone Curette, double-ended  
17.5 cm

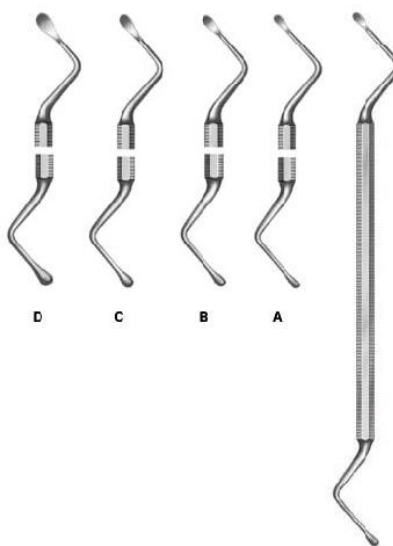

**Lucas**

**FI-7-192-11**

Bone Curette, double-ended  
18 cm

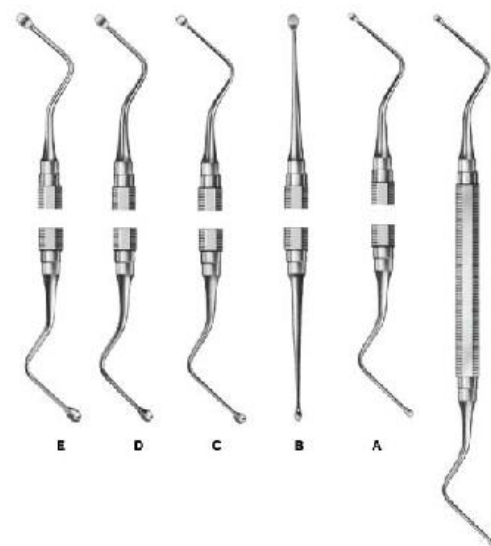

**Miller-Colburn**

**FI-7-193-00**

Bone Curette, double-ended  
17 cm Fig. 0, 17 cm Fig. 1 , 17 cm Fig. 2 , 17 cm Fig. 3



**FISKER**  
INSTRUMENTS

# Surgical Instruments

Bone Surgery

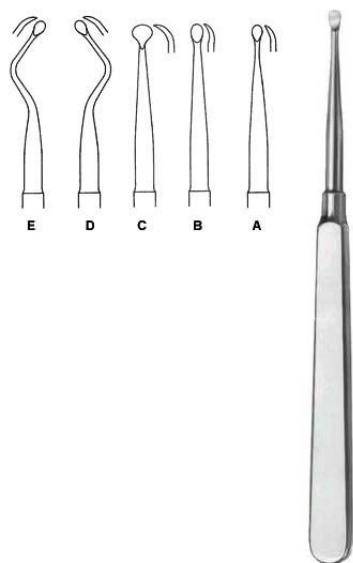

## Molt

**FI-7-194-01**

Bone Curette

17 cm Fig. 1, 17 cm Fig. 2, 17 cm Fig. 3, 17 cm Fig. 4

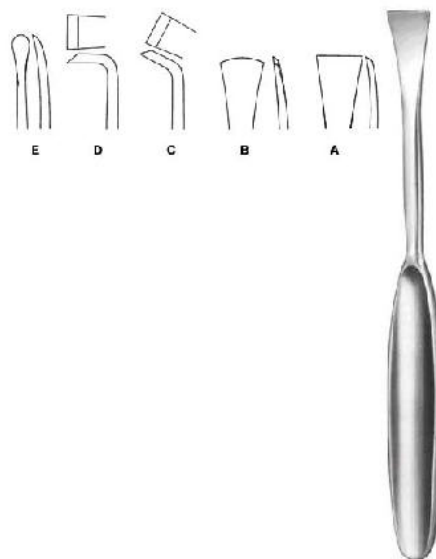

## Martin-Langenbeck

**FI-7-195-01**

Periosteal Elevator

19 cm 16mm



## Langenbeck

**FI-7-196-18**

Periosteal Elevator

18.5 cm



## Langenbeck

**FI-7-197-19**

Periosteal Elevator

19.5 cm



## Periosteal Elevator

**FI-7-198-05**

Periosteal Elevator

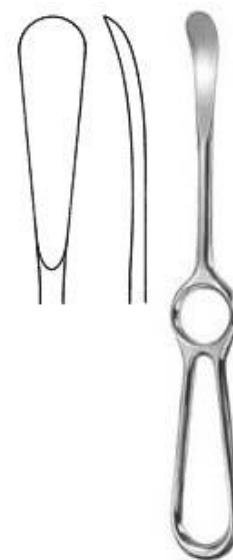

## Sedillot

**FI-7-199-21**

Periosteal Elevator

22 cm 15mm



**FISKER**  
INSTRUMENTS

## Surgical Instruments

Bone Surgery



### Williger

**FI-7-200-13**

Periosteal Elevator  
12.5 cm 5mm



### Kahre-Williger

**FI-7-201-04**

Periosteal Elevator  
4 mm, 5 mm, 7 mm

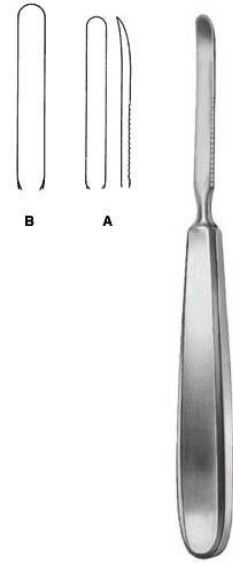

### Periosteal Elevato

**FI-7-202-06**

Periosteal Elevato  
17 cm 6mm , 17 cm 8mm



### Doyen

**FI-7-203-17**

Rib Raspatory  
17.5 cm

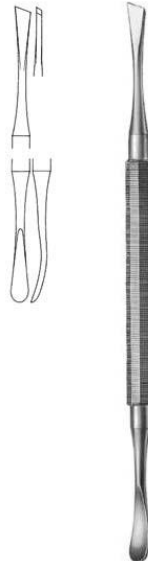

### West

**FI-7-204-19**

Periosteal Elevator, double-ended  
18.5 cm

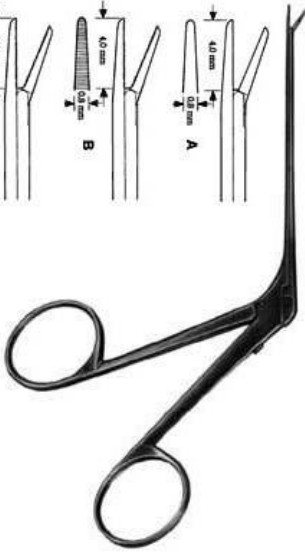
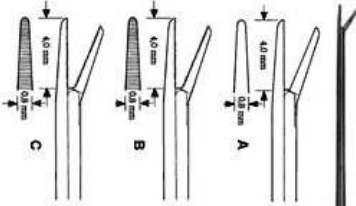

**ENT**

**FI-12-101-01**

Micro Ear Forceps shaft length 80mm, smooth straight, serrated straight

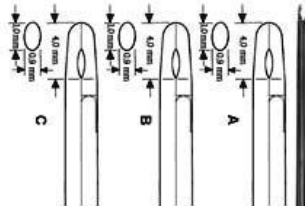

**ENT**

**FI-12-102-01**

Micro Ear Forceps shaft length 80mm, straight, bent upwards

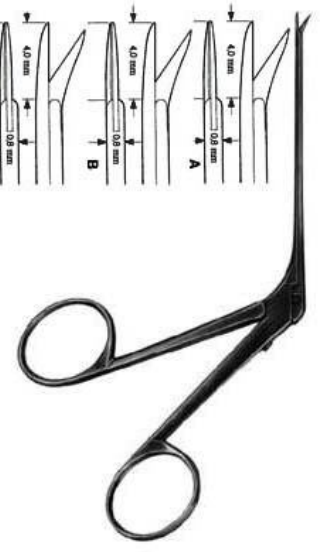
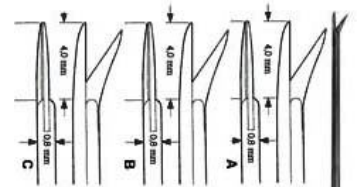

**Bellucci**

**FI-12-103-01**

Micro Ear Scissors shaft length 80 mm



**McGee**

**FI-12-104-11**

Wire Bending Forceps Wire Bending Forceps shaft length 80 mm

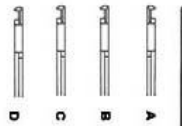

**House-Dieter**

**FI-12-105-01**

Malleus Nipper shaft length 80 mm



**Fuller**

**FI-12-106-01**

Introducing Forceps shaft length 80 mm



**Schuknecht**

**FI-12-107-02**

Rotary Knife

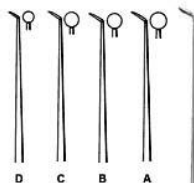

**Rosen**

**FI-12-108-01**

Circular Cut Knife

15 cm Fig. 1 3mm?, 15 cm Fig. 2 2,8mm?, 15 cm Fig. 4 2mm?, 15 cm Fig. 5 1,6mm?, 15 cm Fig. 6 1,4mm?, 15 cm Fig. 7 1,0mm?

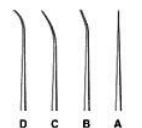

**Barbara**

**FI-12-109-01**

Micro Ear Needle 0,3mm to 2,5mm

16 cm

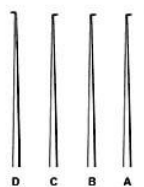

**Micro Ear Hook**

**FI-12-110-01**

Micro Ear Hook 0,3mm to 1,0mm

15.5 cm



**Micro Ear Hook**

**FI-12-111-06**

Micro Ear Hook 0,3mm to 3,0mm, 25, 45, 90

degree



**House**

**FI-12-112-01**

Micro Measuring Rod

15.5 cm 3,5mm, 15.5 cm 4,0mm , 15.5 cm 4,5mm, 15.5 cm 5,0mm



**House**  
**FI-12-113-01**  
Micro Curette  
14.5 cm

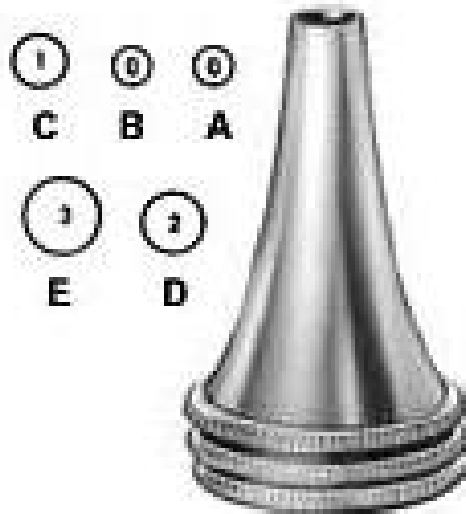

**Hartmann**  
**FI-12-114-03**  
Ear Specula, Set  
3.6 cm Fig. 0, 3.6 cm Fig. 1, 3.6 cm Fig. 2, 3.6 cm Fig. 3, 3.6 cm Fig. 4



**Zollner**  
**FI-12-115-00**  
Ear Specula, Set  
3.8 cm



**Farrior**  
**FI-12-116-01**  
Ear Speculum  
3.8 cm



**Martin-Alloy**  
**FI-12-117-12**  
Tuning Fork  
c2 512



**Hartmann**  
**FI-12-118-10**  
Tuning Fork  
c 128



**Lucae**  
**FI-12-119-10**  
Tuning Fork  
c 128



**Hartmann**  
**FI-12-120-10**  
Tuning Fork  
c 128



**Hartmann**  
**FI-12-121-11**  
Tuning Fork  
c 256

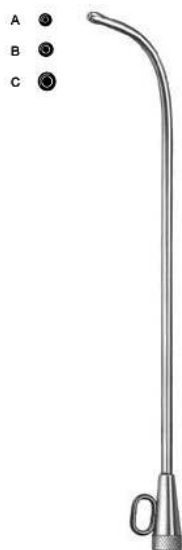

**Hartmann**  
**FI-12-122-01**  
Ear Catheter  
15 cm



**Troeltsch (Wilde)**  
**FI-12-123-11**  
Ear Forceps  
10.5 cm



**Troeltsch (Wilde)**  
**FI-12-124-12**  
Ear Forceps  
11





**FISKER**  
INSTRUMENTS

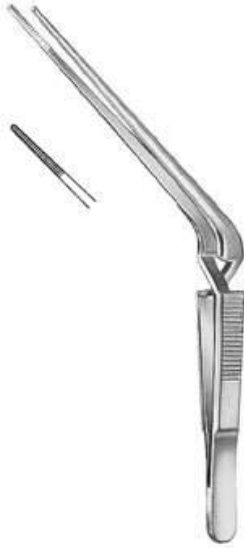

**Troeltsch (Wilde)**

**FI-12-125-13**

Ear Forceps  
12.5 cm



**Grunwald**

**FI-12-126-14**

Ear Forceps  
14.5 cm



**Jansen**

**FI-12-127-16**

Ear Forceps  
16 cm, 21.5 cm

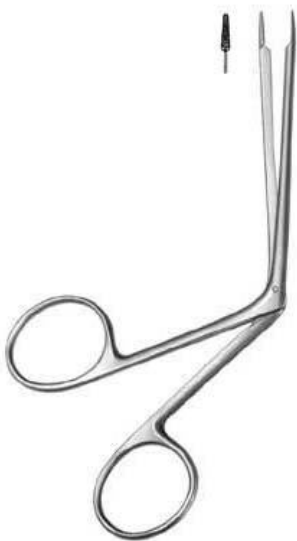

**Littauer**

**FI-12-128-12**

Ear Polypus Forceps  
10 cm



**Hartmann**

**FI-12-129-12**

Ear Polypus Forceps  
12 cm



**Hartmann**

**FI-12-130-14**

Ear Polypus Forceps  
12 cm



**FISKER**  
INSTRUMENTS

## ENT Instruments

Otology



**Hartmann-Wullstein**

**FI-12-131-08**

Ear Polypus Forceps shaft length 85mm



**Citelli**

**FI-12-132-17**

Mastoid Rongeur 3mm cut



**Beyer**

**FI-12-133-19**

Mastoid Rongeur 2mm cut

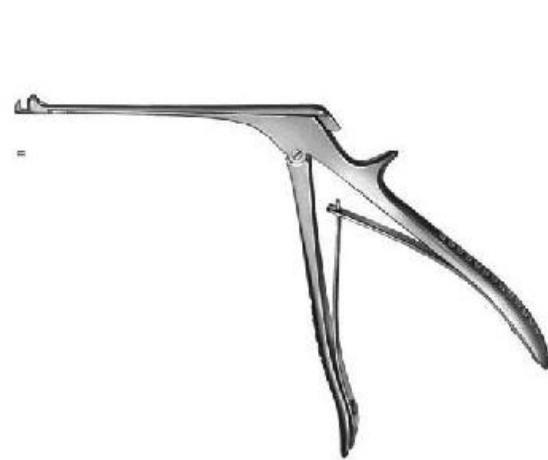

**Beyer**

**FI-12-134-14**

Mastoid Rongeur 1mm cut



**Langenbeck**

**FI-12-135-13**

Ear Curette  
13 cm



**Shapleigh**

**FI-12-136-01**

Ear Curette  
15 cm



**FISKER**  
INSTRUMENTS



**Buck**  
**FI-12-137-02**  
Ear Curette  
17 cm



**Jansen**  
**FI-12-138-15**  
Ear Scoop  
17 cm



**Gross**  
**FI-12-139-12**  
Ear Scoop/Hook  
13 cm



**Weber-Loch**  
**FI-12-140-01**  
Foreign Body Instrument  
16.5 cm



**Billeau**  
**FI-12-141-01**  
Ear Loop  
16 cm



**Zaufal**  
**FI-12-142-16**  
Foreign Body Lever  
15 cm



**FISKER**  
INSTRUMENTS



**Wagener**

**FI-12-143-01**

Ear Hooklet

14 cm Fig. 1 , 14 cm Fig. 2 , 14 cm Fig. 3, 14 cm Fig. 4



**Day**

**FI-12-144-01**

Ear Hooklet

17 cm

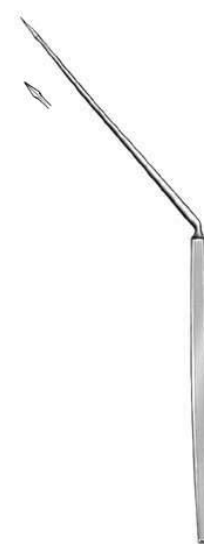

**Politzer**

**FI-12-145-16**

Tympanum Needle

15.5 cm



**Lucae**

**FI-12-146-18**

Tympanum Needle

17.5 cm



**Lempert**

**FI-12-147-20**

Micro Ear Periosteal Elevator

20.5 cm



**Lempert**

**FI-12-148-17**

Micro Ear Periosteal Elevator

18 cm



**FISKER**  
INSTRUMENTS



**Lempert**  
**FI-12-149-10**  
Ear Scoop  
21.5 cm



**Ear Syringe**  
**FI-12-150-00**  
Ear Syringe  
50 ml , 100 ml



**FISKER**  
INSTRUMENTS

## ENT Instruments

Rhinology



**Goldsmith (Thudichum)**

**FI-13-101-01**

Nasal Speculum  
6.5 cm

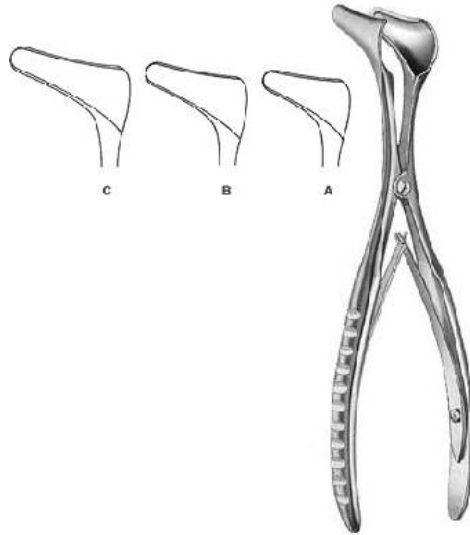

**Hartmann-Halle**

**FI-13-102-01**

Nasal Speculum  
15.5 cm



**Martin**

**FI-13-103-13**

Nasal Speculum  
13 cm



**Martin**

**FI-13-104-13**

Nasal Speculum  
12.5 cm



**Tieck-Halle**

**FI-13-105-13**

Nasal Speculum  
13 cm

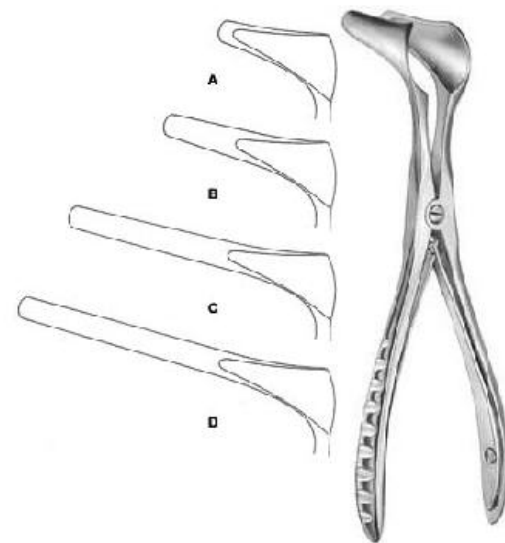

**Killian**

**FI-13-106-01**

Nasal Speculum  
13 cm



**FISKER**  
INSTRUMENTS

## ENT Instruments

Rhinology

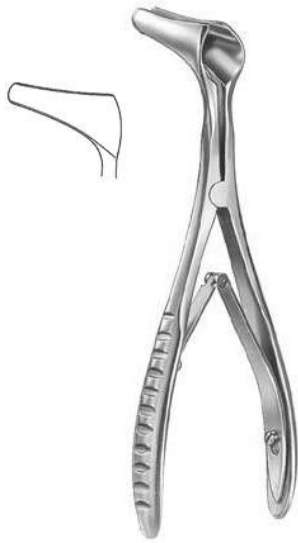

**Modell Wien**

**FI-13-107-14**

Nasal Speculum  
13.5 cm

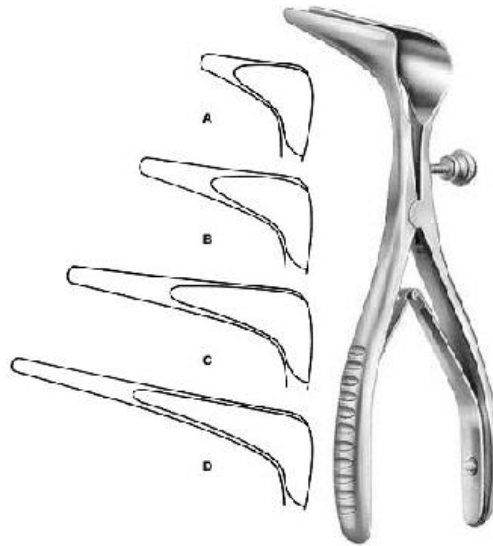

**Cottle**

**FI-13-108-35**

Nasal Speculum  
13.5 cm , 14.5 cm



**Cottle**

**FI-13-109-45**

13.5 cm



**Cottle**

**FI-13-110-15**

Nasal Tampon Forceps  
14.5 cm



**Troeltsch**

**FI-13-111-18**

Nasal Tampon Forceps  
18 cm



**Grunwald (Jansen)**

**FI-13-112-20**

Nasal Tampon Forceps  
21.5 cm



**FISKER**  
INSTRUMENTS

## ENT Instruments

Rhinology



**Lubet-Barbon**

**FI-13-113-20**

Nasal Tampon Forceps  
18.5 cm



**Lubet-Barbon**

**FI-13-114-20**

Nasal Tampon Forceps  
18.5 cm



**Killian**

**FI-13-115-16**

Septum Forceps  
16 cm



**Takahashi**

**FI-13-116-12**

Ethmoid Bone Forceps  
19 cm



**Watson-Williams**

**FI-13-117-10**

Ethmoid Bone Forceps  
19 cm

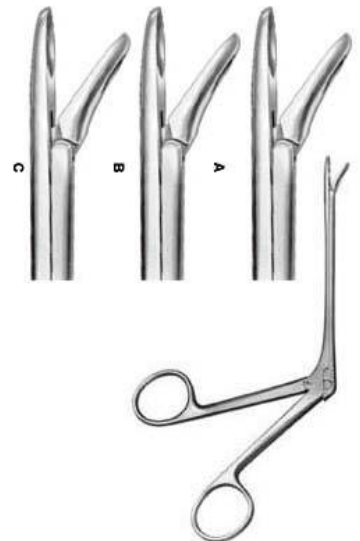

**Weil-Blakesley**

**FI-13-118-01**

Nasal Cutting Forceps  
12 cm





**FISKER**  
INSTRUMENTS

## ENT Instruments

Rhinology

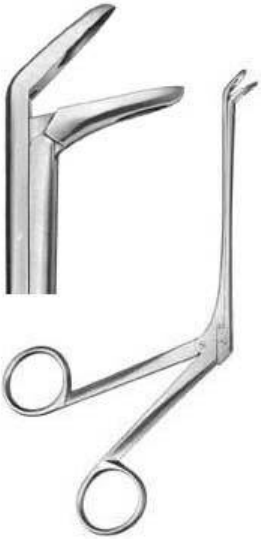

**Weil-Blakesley**

**FI-13-119-01**

Ethmoid Bone Forceps shaft length 120mm

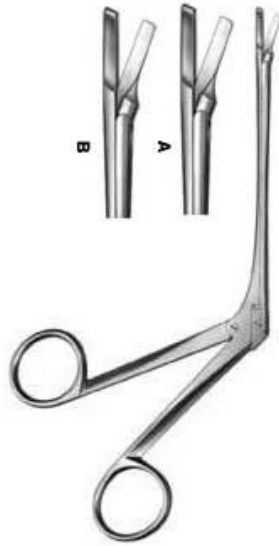

**Struycken**

**FI-13-120-01**

Nasal Cutting Forceps  
19 cm



**Hartmann**

**FI-13-121-01**

Nasal Cutting Forceps  
19 cm



**Schmeden**

**FI-13-122-12**

Nasal Cutting Forceps  
19 cm



**Ferris-Smith-Kerrison**

**FI-13-123-17**

Sphenoid Bone Punch  
18 cm

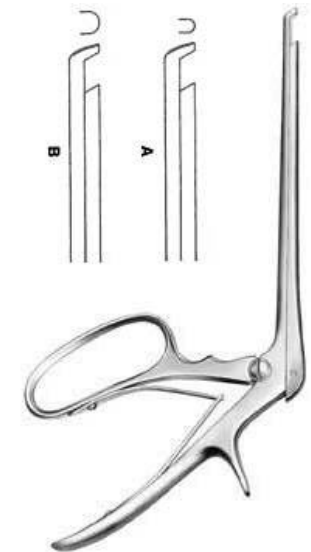

**Ferris-Smith-Kerrison**

**FI-13-124-03**

Sphenoid Bone Punch  
18 cm



**FISKER**  
INSTRUMENTS

## ENT Instruments

Rhinology



### Kerrison

**FI-13-125-00**

Antrum Punch

3 1/4"

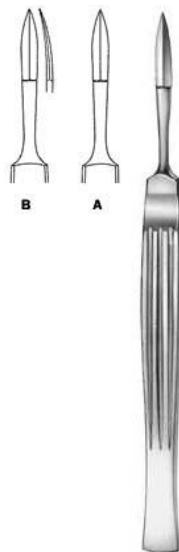

### Joseph

**FI-13-126-01**

Rhinoplastic Knife

15 cm



### Fomon

**FI-13-127-16**

Rhinoplastic Knife

16.5 cm



### Converse

**FI-13-128-16**

Rhinoplastic Knife

16 cm



### Cottle

**FI-13-129-15**

Rhinoplastic Knife

14 cm



### Freer

**FI-13-130-15**

Mucosa Knife

16.5 cm



**FISKER**  
INSTRUMENTS

## ENT Instruments

Rhinology



### McKenty

FI-13-131-04

Septum Elevator

15 cm



### Halle

FI-13-132-16

Septum Elevator

16 cm



### Joseph

FI-13-133-16

Septum Elevator

16 cm



### Freer

FI-13-134-20

Septum Elevator

19 cm

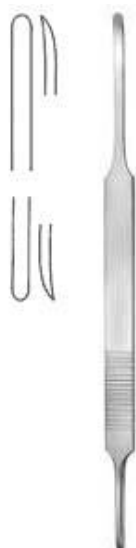

### McKenty

FI-13-135-22

Septum Elevator

20.5 cm



### Ballenger-Hajek

FI-13-136-19

Septum Elevator

19 cm



**FISKER**  
INSTRUMENTS

## ENT Instruments

Rhinology

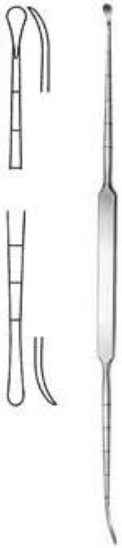

### Cottle

**FI-13-137-22**

Septum Elevator

23 cm



### Masing

**FI-13-138-21**

Periosteal Elevator

19 cm

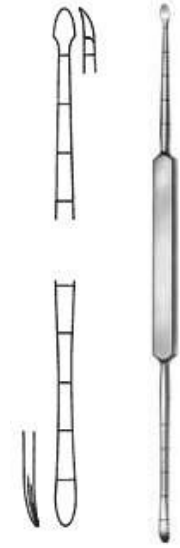

### Cottle

**FI-13-139-21**

Periosteal Elevator

22 cm



### Joseph

**FI-13-140-16**

Periosteal Elevator

18 cm



### Freer

**FI-13-141-15**

Septum Gouge

15 cm



### Killian

**FI-13-142-16**

Septum Gouge

16 cm



**FISKER**  
INSTRUMENTS



**Killian-Claus**

**FI-13-143-16**

Septum Gouge

16 cm

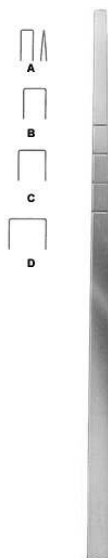

**Cottle**

**FI-13-144-04**

Osteotome

18.5 cm



**Cottle**

**FI-13-145-06**

Osteotome

18.5 cm



**Cottle**

**FI-13-146-16**

Osteotome

18.5 cm



**Walter**

**FI-13-147-03**

Osteotome

19 cm



**Fomon**

**FI-13-148-04**

Chisel

16 cm



**FISKER**  
INSTRUMENTS

# ENT Instruments

Rhinology

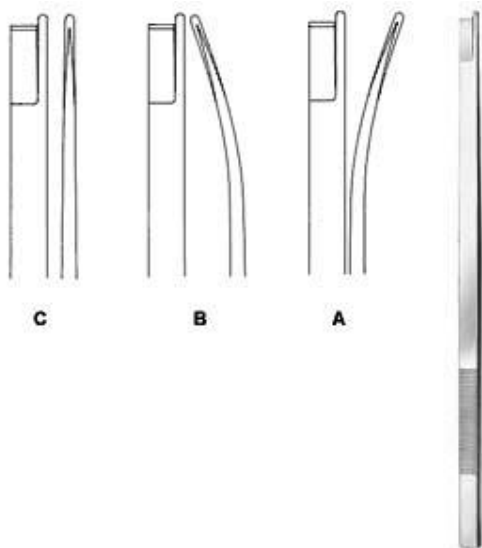

## Neivert-Anderson

**FI-13-149-01**

Osteotome  
20.5 cm

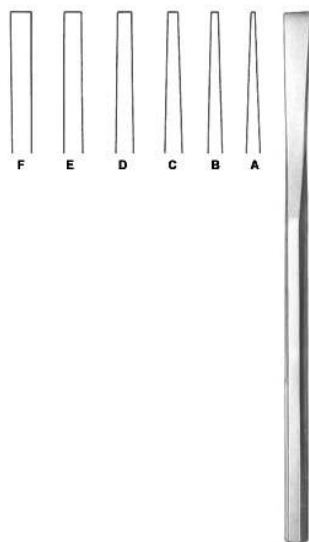

## Sheehan

**FI-13-150-01**

Osteotome  
15 cm

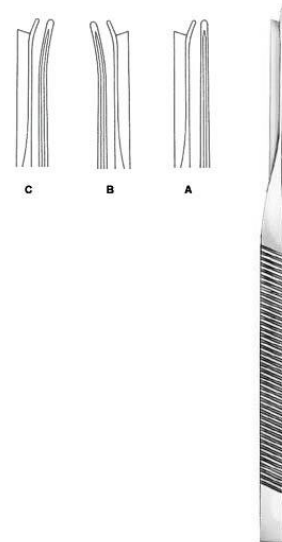

## Silver

**FI-13-151-01**

Rhinoplastic Chisel  
18 cm



## Parkes

**FI-13-152-01**

Osteotome  
16 cm

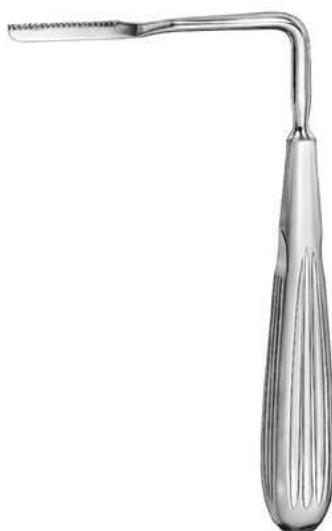

## Joseph

**FI-13-153-20**

Nasal Saw  
17 cm

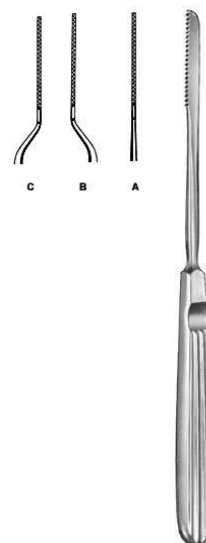

## Joseph

**FI-13-154-00**

Nasal Saw  
19 cm



**FISKER**  
INSTRUMENTS

## ENT Instruments

Rhinology



**Maltz**  
**FI-13-155-18**  
Nasal Rasp  
17.5 cm

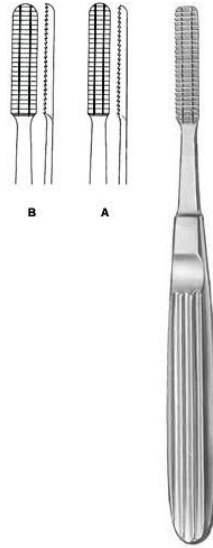

**Maltz**  
**FI-13-156-01**  
Nasal Rasp  
17 cm

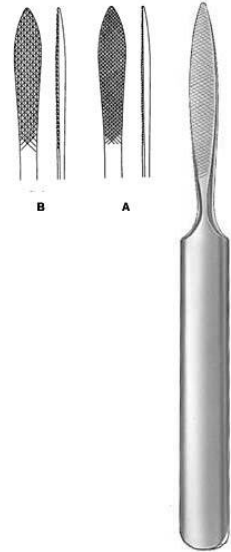

**Joseph**  
**FI-13-157-01**  
Bone File  
16 cm



**Cottle**  
**FI-13-158-21**  
Nasal Rasp  
20.5 cm

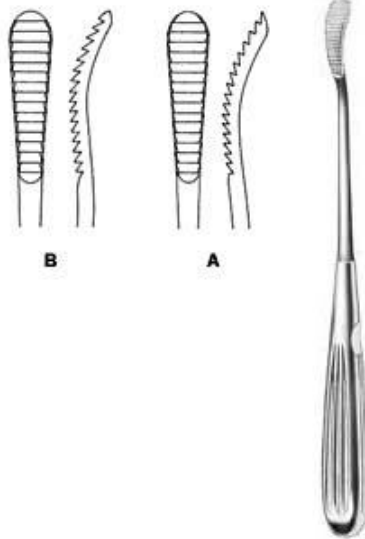

**Aufricht**  
**FI-13-159-21**  
Glabella Rasp  
21 cm

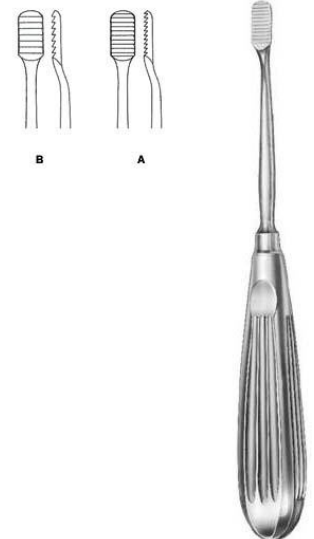

**Lewis**  
**FI-13-160-18**  
Nasal Rasp  
19 cm



**FISKER**  
INSTRUMENTS

## ENT Instruments

Rhinology



**Lewis**  
**FI-13-161-18**  
Nasal Rasp  
19 cm



**Fomon**  
**FI-13-162-01**  
Bone File  
20.5 cm



**Cottle**  
**FI-13-163-01**  
Nasal Hook  
17 cm



**Converse**  
**FI-13-164-01**  
Nasal Retractor  
9 cm



**Converse**  
**FI-13-165-12**  
Alar Hooklet  
11.5 cm



**Freer**  
**FI-13-166-15**  
Mucosa Hooklet  
15 cm





**FISKER**  
INSTRUMENTS

## ENT Instruments

Rhinology



### Joseph

FI-13-167-02

Mucosa Hooklet

16.5 cm

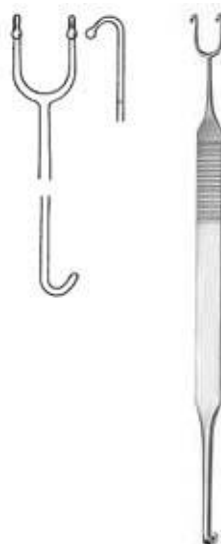

### Cottle-Neivert

FI-13-168-20

Alar Hooklet

19.5 cm



### Cottle

FI-13-169-15

Saddle Hook

14 cm



### Kressner

FI-13-170-20

Septum Forceps

21 cm

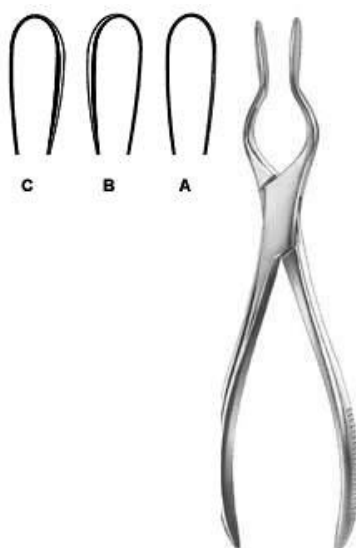

### Cottle-Walsham

FI-13-171-01

Septum Straightening Forceps

23 cm

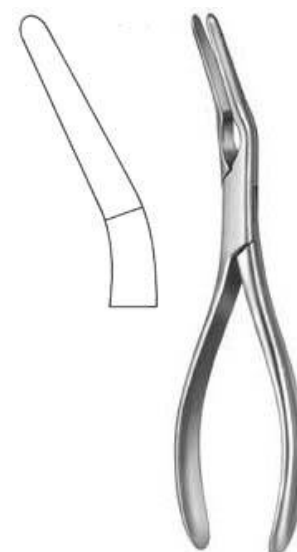

### Asch

FI-13-172-23

Septum Straightening Forceps

22.5 cm



**FISKER**  
INSTRUMENTS



**Ogura**

**FI-13-13-11**

Skin Grasping Forceps

11 cm

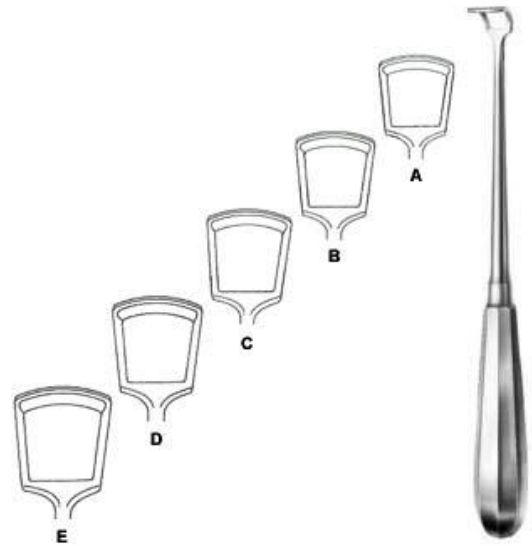

**Beckmann**

**FI-13-174-01**

Adenoid Curette

22.5 cm



**Terry**  
**FI-14-101-16**  
Elevator  
17 cm



**Terry**  
**FI-14-102-00**  
Periosteal Elevator  
18 cm

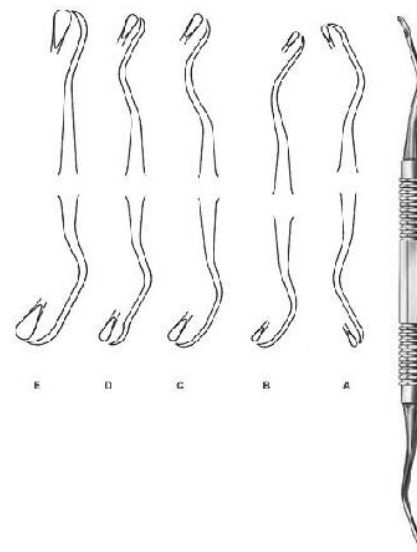

**Sinus Lift Curette**  
**FI-14-103-01**  
Sinus Lift Curette  
18 cm, 17.5 cm, 18.5 cm, 19 cm, 16 cm, 15 cm,  
17 cm



**Heister**  
**FI-14-104-13**  
Mouth Gag  
13 cm



**Molt**  
**FI-14-105-11**  
Mouth Gag  
11 cm



**Denhart**  
**FI-14-106-12**  
Mouth Gag  
13 cm



**FISKER**  
INSTRUMENTS

## ENT Instruments

Oral Instruments

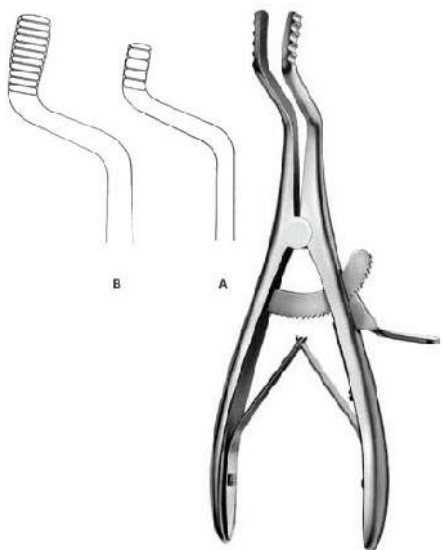

### Roser-Konig

**FI-14-107-16**

Mouth Gag

16 cm

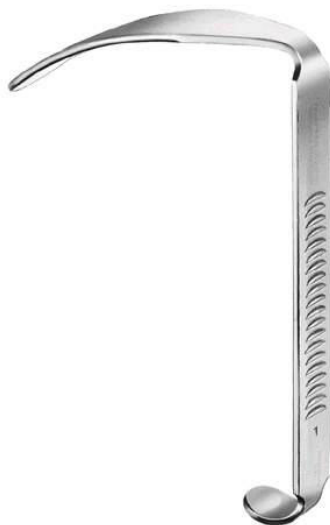

### Roser-Knig

**FI-14-108-16**

Mouth Gag

13.5 cm



### Jennings

**FI-14-109-09**

Mouth Gag

10.5 cm



### Oringer

**FI-14-110-00**

Lip and Cheek Retractor

9.5 cm, 10.5 cm, 10, 11 cm



### Martin-Simplex

**FI-14-111-11**

Cheek Retractor

10.5 cm



### Vestibulum Retractor

**FI-14-112-14**

Vestibulum Retractor

14 cm



**FISKER**  
INSTRUMENTS

## ENT Instruments

### Oral Instruments



#### **Sternberg**

**FI-14-113-14**

Lip and Cheek Retractor

14 cm



#### **Obwegeser**

**FI-14-114-12**

Cheek Retractor

12 cm



#### **Cawood-Minnesota**

**FI-14-115-15**

Cheek Retractor

15 cm



#### **Cheek Retractor**

**FI-14-116-00**

Cheek Retractor

14 cm



#### **Hartmann**

**FI-14-117-15**

Tongue Depressor

15 cm



#### **Tobold**

**FI-14-118-14**

Tongue Depressor

15 cm



**FISKER**  
INSTRUMENTS

## ENT Instruments

Oral Instruments



### Tobold

**FI-14-119-14**

Tongue Depressor

14.5 cm



### Tongue Spatula

**FI-14-120-16**

Tongue Spatula

16 cm



### Tongue Spatula

**FI-14-121-15**

Tongue Spatula

15 cm



### Martin

**FI-14-122-18**

Tongue Spatula

18.5 cm



### Doyen

**FI-14-123-18**

Tongue Spatula

13.5 cm



### Bruennings

**FI-14-124-19**

Tongue Spatula

19 cm



**FISKER**  
INSTRUMENTS

## ENT Instruments

Oral Instruments



**Collin**

**FI-14-125-17**

Tongue Holding Forceps

17 cm



**Young**

**FI-14-126-17**

Tongue Holding Forceps

15 cm



**Obwegeser**

**FI-14-127-40**

Soft Tissue Retractor

21.5 cm



**Obwegeser**

**FI-14-128-22**

Nasal Spine Retractor

22 cm



**Obwegeser**

**FI-14-129-22**

Ramus Retractor

22 cm



**Obwegeser**

**FI-14-130-16**

Chin Retractor

16.5 cm



**FISKER**  
INSTRUMENTS

## ENT Instruments

Oral Instruments



**Obwegeser**

**FI-14-131-18**

Channel Retractor

17 cm



**Retractor**

**FI-14-132-01**

Retractor

18.5 cm



**Periosteal Elevator**

**FI-14-133-01**

Periosteal Elevator

18 cm



**Obwegeser**

**FI-14-134-06**

Periosteal Elevator

17.5 cm



**Obwegeser**

**FI-14-135-21**

Elevator

20.5 cm



**Gillies**

**FI-14-136-21**

Zygoma Elevator

20 cm





**FISKER**  
INSTRUMENTS

## ENT Instruments

Oral Instruments



### Obwegeser

**FI-14-137-21**

Elevator  
20.5 cm



### Rowe

**FI-14-138-01**

Disimpaction Forceps  
22.5 cm



### Rowe

**FI-14-139-01**

Disimpaction Forceps  
22.5 cm



### Dingmann

**FI-14-140-21**

Zygoma Elevator  
21 cm



### Dingmann-Wilk

**FI-14-141-19**

Retractor  
20 cm



### Jeter-Van Sickels

**FI-14-142-01**

Bone Holding Forceps  
18 cm



**FISKER**  
INSTRUMENTS

## ENT Instruments

Oral Instruments



**Keen**

**FI-14-143-01**

Bone Holding Forceps

17.5 cm



**Steinhauser**

**FI-14-144-01**

Bone Holding Forceps

13 cm



**Wolford**

**FI-14-145-25**

Bone Holding Forceps

25 cm



**Salyer**

**FI-14-146-16**

Bone Holding Forceps

16 cm



**Bauer**

**FI-14-147-00**

Osteotome

20.5 cm



**Bauer**

**FI-14-148-00**

Osteotome

20.5 cm



**FISKER**  
INSTRUMENTS

## ENT Instruments

Oral Instruments



**Epker-Bauer**

**FI-14-149-01**

Osteotome  
17.5 cm



**Dautrey-Munro**

**FI-14-150-04**

Osteotome  
16 cm



**Dunn-Dautrey**

**FI-14-151-04**

Osteotome  
16.5 cm



**Dunn-Dautrey**

**FI-14-152-01**

Osteotome  
17 cm



**Epker**

**FI-14-153-04**

Osteotome  
18 cm



**Hargis**

**FI-14-154-19**

Anterior Border Stripper  
19 cm



**FISKER**  
INSTRUMENTS

## ENT Instruments

Oral Instruments



**Hargis**

**FI-14-155-01**

Periosteal Elevator

23 cm



**Hargis**

**FI-14-156-18**

Periform Rim Retractor

18.5 cm



**Hargis**

**FI-14-157-22**

Pterygoid Osteotome

22 cm



**Smith**

**FI-14-158-01**

Sagittal Split Separator

17 cm



**Terry**

**FI-14-159-16**

Mandibular Retractor

16.5 cm



**Terry**

**FI-14-160-24**

Ramus Pusher

24 cm



**FISKER**  
INSTRUMENTS

## ENT Instruments

Oral Instruments



**Terry**

**FI-14-161-00**  
Occlusal Wedge



**Steinhauser**

**FI-14-162-18**  
Elevator  
18.5 cm



**Steinhhauser**

**FI-14-163-07**  
Ramus Osteotome  
17 cm



**Steinhauser**

**FI-14-164-07**  
Chisel  
19 cm



**Steinhauser**

**FI-14-165-01**  
Periosteal Elevator  
16 cm



**Steinh?User**

**FI-14-166-16**  
Steinh?user  
16.5 cm



**FISKER**  
INSTRUMENTS

## ENT Instruments

Oral Instruments



**Steinhilber**  
**FI-14-167-05**  
Orbital Osteotome  
18 cm



**Wolford**  
**FI-14-168-06**  
Osteotome  
23 cm



**FISKER**  
INSTRUMENTS



**Salyer**

**FI-15-101-18**

Cleft Palate Hooklet

18.5 cm



**Salyer**

**FI-15-102-18**

Cleft Palate Hooklet

18.5 cm



**Salyer**

**FI-15-103-08**

Cleft Palate Dissector

18.5 cm



**Salyer**

**FI-15-104-18**

Cleft Palate Dissector

18 cm



**Salyer**

**FI-15-105-18**

Cleft Palate Elevator

18 cm



**Salyer**

**FI-15-106-18**

Cleft Palate Elevator

18 cm



**FISKER**  
INSTRUMENTS

## ENT Instruments

Tonsil



**Salyer**

**FI-15-107-18**

Cleft Palate Elevator

18 cm



**JABOMA**

**FI-15-108-17**

Cleft Palate Periosteal Elevator

17 cm



**Hurd**

**FI-15-109-21**

Cleft Palate Needle

20.5 cm



**Hurd**

**FI-15-111-21**

Cleft Palate Needle

20.5 cm



**Carpenter**

**FI-15-112-25**

Tonsil Knife / Enucleator

25 cm



**Hurd**

**FI-15-113-22**

Tonsil Dissector/Retractor

22.5 cm





**FISKER**  
INSTRUMENTS

## ENT Instruments

Tonsil



**Henke**

**FI-15-114-23**

Tonsil Elevator  
22.5 cm



**Henke**

**FI-15-115-23**

Tonsil Elevator  
22.5 cm

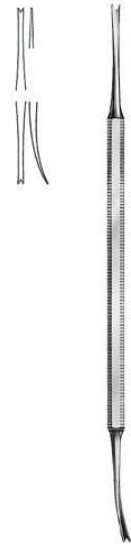

**Luniatschek**

**FI-15-116-19**

Gauze Packer  
17.5 cm



**Luniatschek**

**FI-15-116-19**

Gauze Packer  
17.5 cm



**White**

**FI-15-118-18**

Tonsil Grasping Forceps  
18 cm



**Blohmke**

**FI-15-119-20**

Tonsil Grasping Forceps  
20 cm



**FISKER**  
INSTRUMENTS

## ENT Instruments

Tonsil

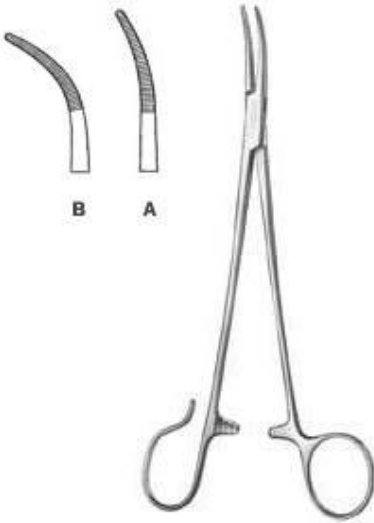

### Schnidt

**FI-15-120-19**

Tonsil Forceps  
19 cm

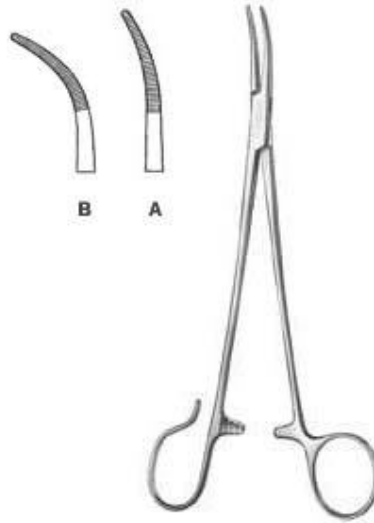

### Schnidt

**FI-15-121-19**

Tonsil Forceps  
19 cm , 18.5 cm



### Eves

**FI-15-122-28**

Tonsil Snare  
28.5 cm



### Eves

**FI-15-123-28**

Tonsil Snare  
28.5 cm

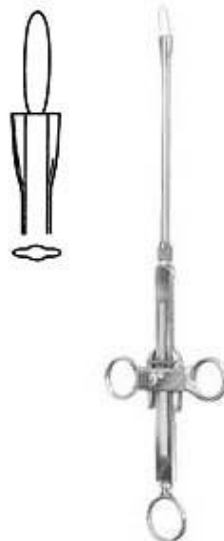

### Brunings

**FI-15-124-28**

Tonsil Snare  
29 cm

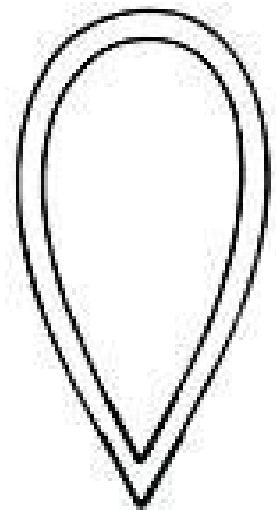

### Wire Loop

**FI-15-125-40**



**FISKER**  
INSTRUMENTS

## ENT Instruments

Tonsil



**Snare Wire**

FI-15-126-01

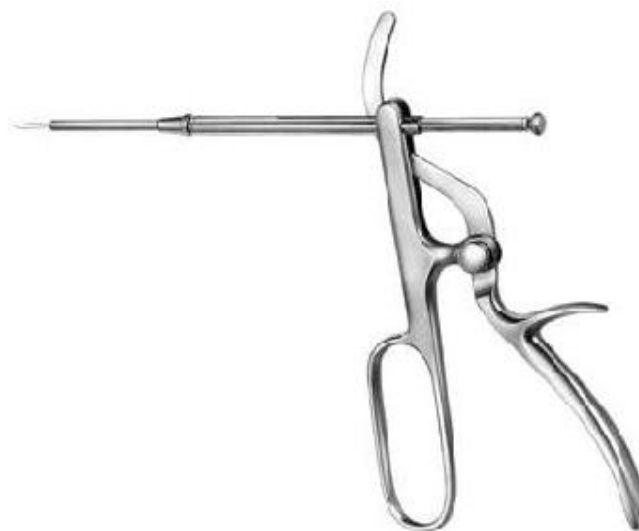

**Tyding**

FI-15-127-01

Tonsil Snare



**Hartmann**

FI-15-128-13

Tonsil Punch

12 cm



**Huber**

FI-15-129-01

Universal Handle

20 cm, 30 cm, 40.5 cm



**Bruenings**

FI-15-130-20

Interchangeable Tube



**Bruenings**

FI-15-131-20

Laryngeal Tube

20 cm



**FISKER**  
INSTRUMENTS

Manufacturers & Exporters of Surgical, Dental, Manicure,  
Veterinary , Eye , TC , Single & Hollowware Instruments

**Address:** Defance Road, Hadi Town Near  
Jamia Qadria P.O.Box 322  
Sialkot-51310 Pakistan.

**Tel:** +92 324 0087186

**WhatsApp:** +92 324 0087186

**E-mail:** [info@fiskerinstruments.com](mailto:info@fiskerinstruments.com)

**Website:** [www.fiskerinstruments.com](http://www.fiskerinstruments.com)



**CONTACT US**