



FISKER
INSTRUMENTS

Manufacturers & Exporters of Surgical, Dental, Orthodontic,
Hollow Wears & Manicure Instruments.



Catalogue

DENTAL
Instruments

Dear Valued Buyers

We feel immense pleasure to present our latest catalogue in which we have featured a most comprehensive range of all types of quality Surgical & Dental instruments required for day to day use for Hospital. We will be pleased to quote you a competitive Price and Delivery time.

All instruments are manufactured according to the recognized standard patterns currently in use in Hospital throughout the world and are being produced under restrict control of experts to avoid any flaw and to refrain any complaint at any stage.

A group of very vast experienced persons in manufacturing handling our quality Control System.

Any instruments proven defective in workmanship or material will be replaced with out charges.

We express our thanks to all our customers for the confidence they have placed us in the past. We further assure them that we will continue our best efforts to gain their confidence in the future.

We are always at your service.

Chief Executive



01

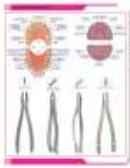

EXTRACTING FORCEPS

Page # 01 - 14H

02



ROOT ELEVATORS

Page # 15 - 29

03



**DIAGNOSTIC, PROBES, SCALERS, FILLING
& LABORATORY INSTRUMENTS**

Page # 30 - 77

04



**MAXILLOFACIAL SURGERY
INSTRUMENTS**

Page # 78 - 95

05



**ORTHODONTIC INSTRUMENTS
& PLIERS**

Page # 96 - 107

06



DENTAL IMPLANT INSTRUMENTS

Page # 108 - 142

07

impression Tray & Hollow wares

Page # 143 - 148

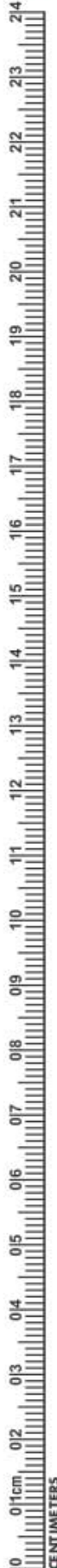

Handle Selection For Extracting Forceps

Dear Valued Buyers if any Universal Fig. No. of Extracting Forceps not Found in our Catalogue you Can Refer the Fig. No. From These Diagram.

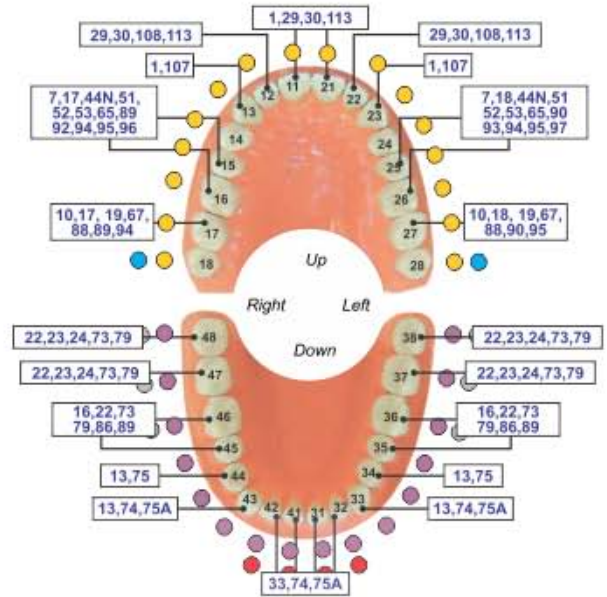
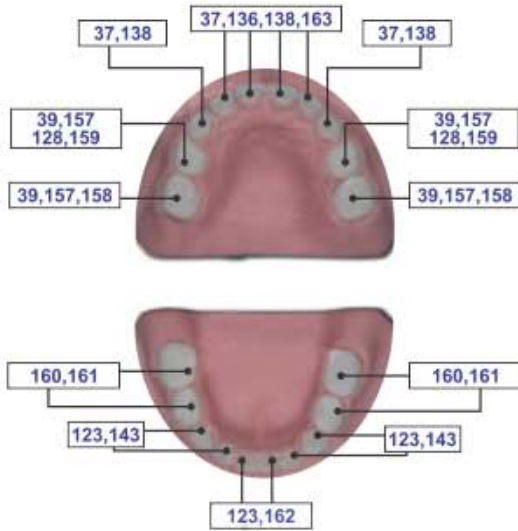

Dear Valued Buyers these are our Handle Styles



English Pattern



English Pattern



English Pattern, Anatomical Handle



American Pattern



Deep Grip Forceps With Hole Pattern



Hole Pattern



A



B



C



D



E



F



- Щипцы экстракционные (английская форма)
- Daviers (Forme Anglaise)
- Zahnzangen (Englische Form)

- Щипці екстракційні (англійська форма)
- Forceps de Extracción (Forme Inglesa)
- استخراج المنقط (نمط اللغة الإنجليزية)

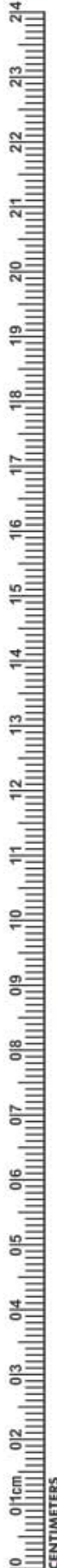

DE-001
 Fig. 1
 Upper Centrals
 and Canines



DE-002
 Fig. 2
 Upper Laterals
 and Canines



DE-003
 Fig. 4
 Lower Incisors
 and Canines



DE-004
 Fig. 7
 Upper Premolars



DE-005
 Fig. 8
 Lower Premolars



DE-006
 Fig. 13
 Lower Premolars



DE-007
 Fig. 17
 Upper Molars,
 Right



DE-008
 Fig. 18
 Upper Molars,
 Left



DE-009
 Fig. 21
 Lower Molar



DE-010
 Fig. 22
 Lower Molar

EXTRACTING FORCEPS (English Pattern)

- Щипцы экстракционные (английская форма)
- Daviers (Forme Anglaise)
- Zahnzangen (Englische Form)
- Щипці екстракційні (англійська форма)
- Forceps de Extracción (Forme Inglesa)
- استخراج الملقط (نمط اللغة الإنجليزية)



DE-011
18A
upper molars



DE-012
19
upper third molars



DE-013
20
lower third molar



DE-014
24
lower molar, right



DE-015
29
upper roots



DE-016
30
Upper Roots



DE-017
33
lower roots



DE-018
33A
Lower Roots



DE-019
33M
Lower roots
with long beak



DE-020
46L
Upper Roots



DE-021
51
Upper Roots



DE-022
51A
Upper Roots



- Щипцы экстракционные (английская форма)
- Щипці екстракційні (англійська форма)
- Daviers (Forme Anglaise)
- Forceps de Extracción (Forme Inglesa)
- Zahnzangen (Englische Form)
- استخراج المسقط (نمط اللغة الإنجليزية)

WISDOM EXTRACTING FORCEPS



DE-023
Routerier
 (# 22 ½ L)
 lower molars and
 wisdoms, left



DE-024
Routerier
 (# 22 ½ R)
 lower molars and
 wisdoms, right



DE-025
Routerier
 (# 33 ½ L)
 lower molar and
 wisdom roots, left



DE-026
Routerier
 (# 33 ½ R)
 lower molar and
 wisdom roots, right



DE-027
Fig. 186L
 lower molars



DE-028
Fig. 186R
 lower molars



DE-029
51AL



DE-030
67
 Upper Thrid Molars



DE-031
67A
 Upper Thrid Molars



DE-032
79
 Lower Third Molars



EXTRACTING FORCEPS (English Pattern)

- Щипцы экстракционные (английская форма)
- Daviers (Forme Anglaise)
- Zahnzangen (Englische Form)
- Щипці екстракційні (англійська форма)
- Forceps de Extracción (Forme Inglesa)
- استخراج الملقط (نمط اللغة الإنجليزية)



DE-033
73
Lower Molars



DE-034
73 A
lower molars



DE-035
73 S



DE-036
74
Lower Roots



DE-037
74N
Lower Roots



DE-038
75
Lower Premolars



DE-039
86A
Lower Molars



DE-040
86B
lower molars



DE-041
86C
lower molars



DE-042
87
Lower Molars



DE-043
89
Upper Molars,
Right



DE-044
90
Upper Molars,
Left



- Щипцы экстракционные (английская форма)
- Daviers (Forme Anglaise)
- Zahnzangen (Englische Form)

- Щипці екстракційні (англійська форма)
- Forceps de Extracción (Forme Inglesa)
- استخراج المنقط (نمط اللغة الإنجليزية)

A-TRAUMATIC EXTRACTION
 Improved tapered beaks for complete root contact. Cross serrations.
 Deep Gripe Extracting Forceps



- No Fracture
- No Tissue Damage
- Extraction With Easy



Thin Tip



DE-045
34
 Upper incisors and
 premolars
 deep-gripping



Wide Tip



DE-046
34A
 Upper centrals / cains
 deep-gripping



Thin Tip



DE-047
Fig. 35
 upper premolars
 deep-gripping



Wide Tip



DE-048
35A
 Upper incisors and
 premolars
 deep-gripping



Thin Tip



DE-049
36
 Lower premolars
 deep-gripping



Wide Tip



DE-050
36A
 Lower premolars
 deep-gripping



DE-051
336
 lower premolars
 deep-gripping



DE-052
F-7C
 lower molar



DE-053
9
 Apex Forceps Lower Universal
 Deep Root Pick



DE-054
79N
 Lower third molars
 deep-gripping



DE-055
79
 Lower Third Molars



EXTRACTING FORCEPS (English Pattern)

- Щипцы экстракционные (английская форма)
- Daviers (Forme Anglaise)
- Zahnzangen (Englische Form)
- Щипці екстракційні (англійська форма)
- Forceps de Extracción (Forme Inglesa)
- استخراج الملقط (نمط اللغة الإنجليزية)

DEEP GRIP FORCEPS



DE-056
146

Apex Forceps Lower Root
Deep Root Pick



DE-057
153

Apex Forceps Upper Root
Deep Root Pick



DE-058
149

Apex Forceps Upper Root
Deep Root Pick



DE-061
Fig. 44



DE-060
Fig. 44Z



DE-059
Fig. 45Z



DE-062
46XL
Apex Forceps Lower Root
Deep Root Pick



DE-063
67
Upper Third Molars

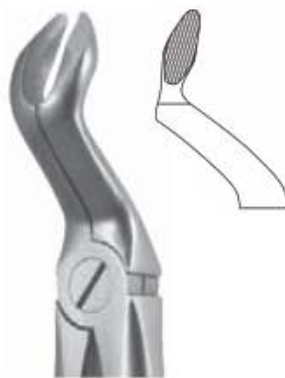

DE-064
67A
Upper Third Molars



DE-065
67N
Lower third molars
deep-gripping



DE-066
331
upper roots
deep-gripping



EXTRACTING FORCEPS (English Pattern)

- Щипцы экстракционные (английская форма)
- Daviers (Forme Anglaise)
- Zahnzangen (Englische Form)

- Щипці екстракційні (англійська форма)
- Forceps de Extracción (Forme Inglesa)
- استخراج المنقط (نمط اللغة الإنجليزية)

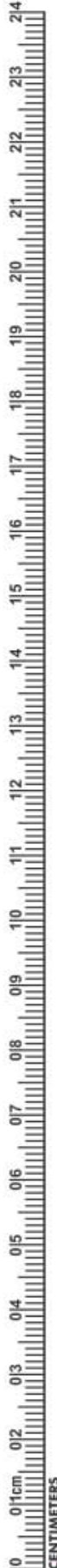

Fig. 1
upper
laterals
and canines



DE-067 Set of 10 Pieces

- Fig. 1
- Fig. 7
- Fig. 13
- Fig. 17
- Fig. 18
- Fig. 22
- Fig. 51A
- Fig. 67
- Fig. 74N
- Fig. 79

Fig. 7
upper
premolars



Fig. 13
lower
premolars



Fig. 17
upper
molars,
right



Fig. 18
upper
molars,
left



Fig. 22
lower
roots



FISHER
INSTRUMENTS

Fig. 51A
upper roots



Fig. 67
upper third
molars



Fig. 74N
lower
molar



Fig. 79
lower third
molars



EXTRACTING FORCEPS

- Щипцы экстракционные
- Daviers
- Zahnzangen
- Щипці екстракційні
- Forceps de Extracción
- استخراج الملقط

Pediatric Tooth Extracting Forceps Set



DE-069
English Pattern Klein #51S
Pedodontic Upper root



DE-068
English Pattern Klein #137
Pedodontic, Upper Incisors Spring handle



DE-072
English Pattern Klein #5
Pedodontic Lower Incisors.



DE-070
English Pattern Klein #139
Pedodontic Upper Premolars

Baby Tooth Extraction Forceps



Fig. # 01 to 07
Set of 7 Pieces



DE-073
English Pattern Klein #7
Pedodontic Lower Roots,



DE-071
English Pattern Klein #3
Pedodontic Upper Molars Universal

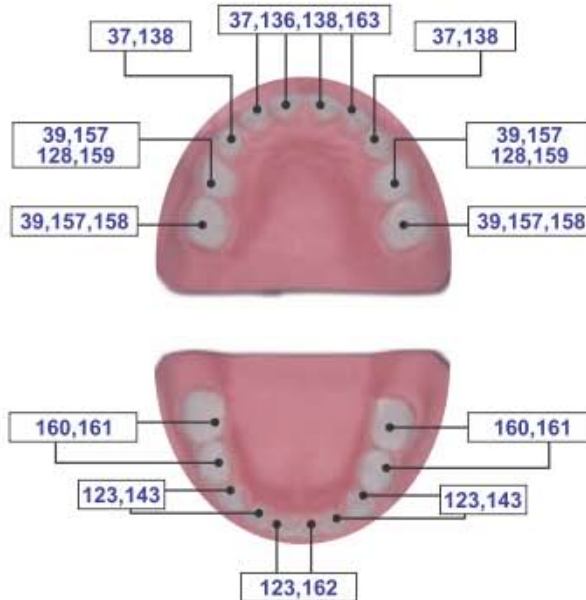

DE-074
English Pattern Klein #6
Pedodontic Lower Molars, Spring Handle



EXTRACTING FORCEPS (American Pattern)

- Щипцы экстракционные (американская форма)
- Daviers - forme américaine
- Fórceps de extracción - forma americana
- Щипці екстракційні (американська форма)
- Pinzoper per estrazione - forma americana
- استخراج المنقط (المنقط الأمريكي)



DE-075
1STD
Winter
upper centrals and canines



DE-076
Fig. 1
upper incisors
and roots



DE-077
Cryer
Fig. 150



EXTRACTING FORCEPS (American Pattern)

- Щипцы экстракционные (американская форма)
- Щипці екстракційні (американська форма)
- Daviers - forme américaine
- Pinzere per estrazione - forma americana
- Fórceps de extracción - forma americana
- استخراج المنقط (النمط الأمريكي)



DE-079
Fig. 62
incisors, premolars,
deciduous teeth



DE-080
10S
upper roots



DE-081
17
lower molars



DE-082
Harris
Fig. 18R



DE-083
Harris
Fig. 18L

DE-078
Fig. 150A
Cryer

upper incisors, premolars, roots



EXTRACTING FORCEPS (American Pattern)

- Щипцы экстракционные (американская форма)
- Daviers - forme américaine
- Fórceps de extracción - forma americana
- Щипці екстракційні (американська форма)
- Pinzoper per estrazione - forma americana
- استخراج المنقط (النمط الأمريكي)



DE-084
 Fig. 210
 upper third molars



DE-085
 Fig. 53R
 upper molars, right



DE-086
 Fig. 53L
 upper molars, left



DE-087
 NEVIUS
 Fig. 88R



EXTRACTING FORCEPS (American Pattern)

- Щипцы экстракционные (американская форма)
- Daviers - forme américaine
- Fórceps de extracción - forma americana
- Щипці екстракційні (американська форма)
- Pinzere per estrazione - forma americana
- استخراج المنقط (النمط الأمريكي)



DE-088
Fig. 24
upper molars



DE-089
210S
upper third molars



DE-090
210H
upper third molars



DE-091
286
Upper Roots,
Premolars, Incisors

FISKER
INSTRUMENTS



DE-092
99C
Kells
upper incisors,
canines, premolars



DE-093
222
lower third molars



DE-094
286
Lower Molar



EXTRACTING FORCEPS (American Pattern)

- Щипцы экстракционные (американская форма)
- Daviers - forme américaine
- Fórceps de extracción - forma americana
- Щипці екстракційні (американська форма)
- Pinzere per estrazione - forma americana
- استخراج المنقط (النمط الأمريكي)



DE-095
 Nevis
 Fig. 88L
 upper molars, left



DE-096
 Fig. 65
 upper incisors
 and roots



DE-097
 Parmlly Fig. 32A
 upper premolars
 and roots



DE-098
 Parmlly Fig. 32
 upper premolars
 and molars



EXTRACTING FORCEPS (American Pattern)

- Щипцы экстракционные (американская форма)
- Dáviers - forme américaine
- Férceps de extracción - forma americana
- Щипці екстракційні (американська форма)
- Pinzere per estrazione - forma americana
- استخراج المنقط (النمط الأمريكي)



DE-099
COHEN
universal

DE-100
Fig. 203
lower incisors
and roots

DE-101
Tomes Fig. 69
upper and lower
roots

EXTRACTING FORCEPS (American Pattern)

- Щипцы экстракционные (американская форма)
- Daviers - forme américaine
- Fórceps de extracción - forma americana
- Щипці екстракційні (американська форма)
- Pinzere per estrazione - forma americana
- استخراج المنقط (المنقط الأمريكي)



DE-102
 Fig. 23
 lower molars



DE-103
 Fig. 16
 lower molars



DE-104
 Physic Fig. 5
 lower third molars



DE-105
 Harris Fig. 15
 lower molars



DE-106
 Fig. 103



EXTRACTING FORCEPS (American Pattern)

- Щипцы экстракционные (американская форма)
- Щипці екстракційні (американська форма)
- Pinzere per estrazione - forma americana
- مستخراج المنقط (النمط الأمريكي)
- Daviers - forme américaine
- Fórceps de extracción - forma americana



DE-107
Hull
Fig. 101
Deciduous teeth

DE-108
Cryer
Fig. 150S
upper teeth,
for children

DE-109
Fig. 150 AS

EXTRACTING FORCEPS (American Pattern)

- Щипцы экстракционные (американская форма)
- Daviers - forme américaine
- Fórceps de extracción - forma americana
- Щипці екстракційні (американська форма)
- Pinzere per estrazione - forma americana
- استخراج المنطق (النمط الأمريكي)

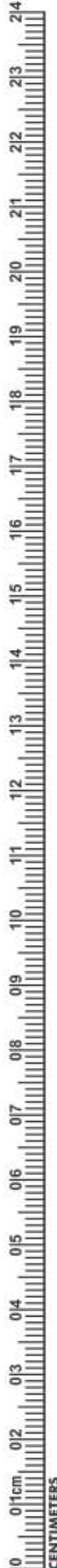

DE-110
 Cryer
 Fig. 151
 lower teeth,
 for children

DE-111
 Fig. 151 S
 lower incisors,
 premolars, roots

DE-112
 Fig. 151 AS

EXTRACTING FORCEPS (American Pattern)

- Щипцы экстракционные (американская форма)
- Daviers - forme américaine
- Férceps de extracción - forma americana
- Щипці екстракційні (американська форма)
- Pinzere per estrazione - forma americana
- استخراج المنقط (النمط الأمريكي)



DE-113
16S
lower molars for children



DE-114
17S
lower molars



DE-115
23 S
Lower molars

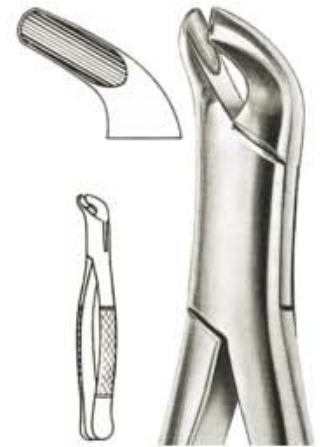

DE-116
27
lower molars



DE-117
18LS
upper molars left



DE-118
18RS
upper molars right



DE-119
85 Tomas
lower canines, premolars and molars



DE-120
85A Tomas
lower canines, premolars and molars



DE-121
69S
upper and lower roots



DE-122
99A Kells
upper incisors, canines, premolars



DE-123
217
lower molars



EXTRACTING FORCEPS (American Pattern)

- Щипцы экстракционные (американская форма)
- Daviers - forme américaine
- Fórceps de extracción - forma americana
- Щипці екстракційні (американська форма)
- Pinzeta per estrazione - forma americana
- استخراج المنطق (المنطق الأمريكي)



DE-124
#10 SK
 Upper Molars Sup



DE-125
#17 SK Universal
 Lower Molars



DE-126
#23 SK Universal
 Upper Molars



DE-127
#69 SK Tomas
 upper and lower roots



DE-128
#99 SK
 upper incisors,
 canines, premolars



DE-129
#150 SK
 upper incisors,
 premolars, roots



DE-130
#151 SK
 lower incisors,
 premolars, roots



DE-131
#222 SK
 lower third molars



FISHER
 INSTRUMENTS



EXTRACTING FORCEPS (American Pattern)

- Щипцы экстракционные (американская форма)
- Щипці екстракційні (американська форма)
- Daviers - forme américaine
- Pinzere per estrazione - forma americana
- Fórceps de extracción - forma americana
- استخراج المنقط (النمط الأمريكي)



DE-132
Fig. 1
Upper Anterior

DE-133
Lower Molar
Fig. 23 Cow Horn



DE-134
Fig. 74
Lower Anterior



DE-135
Fig. 88L
Upper Molar Left



DE-136
Fig. 88R
Upper Molar Right



DE-137
Fig. 74
Lower Anterior



DE-138
Fig. 106
Lower Incisors



DE-139
Fig. 174
Extra Narrow
Lower Anterior
Apical Retention
Forceps



DE-140
Fig. 859
Lower Molars
Roots



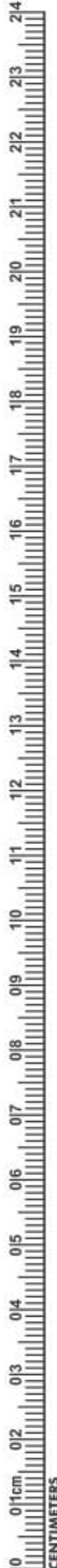

- Шприцы стоматологические карпульные
 - Seringues à usage dentaire
 - Dentalspritzen
- Шприцы стоматологічні карпульні
 - Jeringas dentales
 - المحاقن الأسنان



DE-141 1.8ML
DE-142 2.2ML



DE-143 1.8ML
DE-144 2.2ML



DE-145 1.8ML
DE-146 2.2ML



DE-147 1.8ML
DE-148 2.2ML



DE-149 1.8ML
DE-149A 2.2ML



DE-149B 1.8ML
DE-149C 2.2ML



DE-149D
1001
Intraligamental
Anesthesia
Syringe in
Black Colour



DE-149E 1.8ML
DE-149F 2.2ML
Angled



DE-149G
Aluminium - Dark 1.8 ml

- | | | | |
|---|---|---|---|
|  |  |  |  |
| DE-149H
Aluminium -
Silver 1.8 ml | DE-149I
Aluminium -
Orange 1.8 ml | DE-149J
Aluminium -
Green 1.8 ml | DE-149K
Aluminium -
Blue 1.8 ml |



Type C
DE1-149 1,8ml.
DE2-149 2,2ml



Type C
DE3-149 1,8ml
DE4-149 2,2ml



2-Ring
DE5-149 1,8ml.
DE6-149 2,2ml



Aspirating Syringe
DE7-149 1.8mm
DE8-149 2.2mm



Cartridge Syringe
DE9-149 1.8mm
DE10-149 2.2mm



Cartridge Syringe
DE11-149 1.8mm
DE12-149 2.2mm



Cartridge Syringe
DE13-149 1.8mm
DE14-149 2.2mm

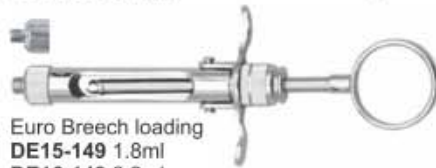

Euro Breech loading
DE15-149 1.8ml
DE16-149 2.2ml

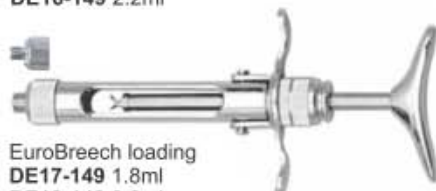

EuroBreech loading
DE17-149 1.8ml
DE18-149 2.2ml



Manual Aspirating Syringe
DE19-149 1.8ml
DE20-149 2.2ml



Quatro
DE21-149 1.8ml
DE22-149 2.2ml



Trio
DE23-149 1.8ml
DE24-149 2.2ml



Swedish Type
DE25-149 1.8ml
DE26-149 2.2ml



Ject Ultima
DE27-149 1.8ml
DE28-149 2.2ml
Injects 0.05 ml with every click Supplied with
angled and straight tubes



Ject angled
DE29-149 1.8ml
DE30-149 2.2ml

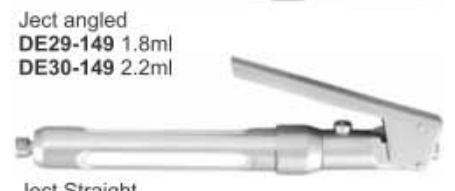

Ject Straight
DE31-149 1.8ml
DE32-149 2.2ml



Disc System
DE33-149 1.8ml
DE34-149 2.2ml



Disc System
DE35-149 1.8ml

BONE ROUNGER

- Костные кусачки
- Hohlmeißelzangen
- Pincas-gouges
- Кусачки для кісток
- Pinzas-gubias
- رونجیورس العظام



DE-149L
Blumenthal
15cm



DE-149M
Blumenthal
15cm



DE-149N
Blumenthal
15cm



DE-149O
Friedman
14cm



DE-149P
Friedman
14.5cm



DE-149Q
Micro-Friedman
14cm



DE-149R
Micro-Friedman
15cm



DE-149S
Micro-Friedman
16cm



DE-149T
Kleinert-Kutz
18.5cm



DE-149U
Beyer
18.5cm



DE-149V
Mead 1A
18.5cm



DE-149W
Luer
18.5cm



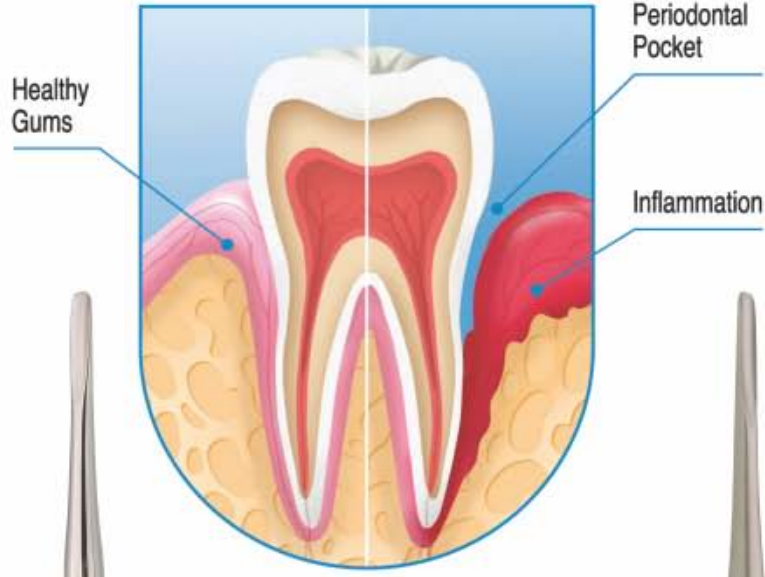
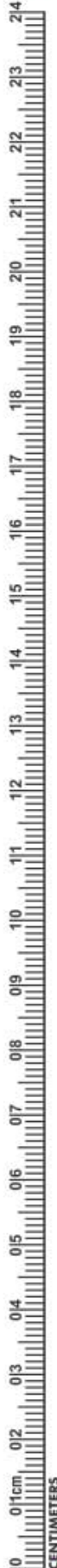

**HANDLES FOR ROOT ELEVATORS POINTS
A, B, C, D**

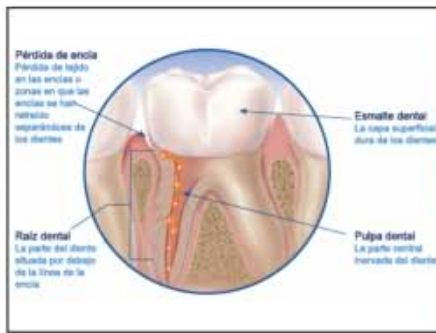

ROOT ELEVATOR

- Элеватор корневой экстракционный
- Elévateurs à racines
- Wurzelheber
- Слеватор корневий экстракційний
- Elevadores para raices
- المصاعد الجذر

Apexo Root Elevators



Apexo



DE-150
Apexo
2.5x9mm
Straight



DE-151
Apexo
2.7x9mm
Straight



DE-152
Apexo
3.0x9mm
Straight



DE-153
Apexo
2.5x9mm
Curved



DE-154
Apexo
3.0x9mm
Curved



DE-155
Seldin
3.0x14mm
Straight

Luxator Root Elevators



Luxator



DE-156
Luxator
3mm
straight



DE-157
Luxator
3mm
curved



DE-158
Luxator
4mm
straight



DE-159
Luxator
4mm
curved



DE-160
Luxator
5mm
straight



DE-161
Luxator
5mm
curved

Bein Root Elevators



Bein



DE-162
Bein 2mm



DE-163
Bein 3mm



DE-164
Bein 4mm

Seldin Root Elevators



Seldin



DE-165
Flohr 1



DE-166
Seldin 34S



DE-167
Seldin 34



- Элеватор корневой экстракционный
- Elévateurs à racines
- Wurzelheber
- Слеватор корневий екстракційний
- Elevadores para raíces
- المصاعد الجذر

Apexo Root Elevators

Apexo

DE-168
 Apexo
 2.5x9mm
 Straight

DE-169
 Apexo
 2.7x9mm
 Straight

DE-170
 Apexo
 3.0x9mm
 Straight

DE-171
 Apexo
 2.5x9mm
 Curved

DE-172
 Apexo
 3.0x9mm
 Curved

DE-173
 Seldin
 3.0x14mm
 Straight

Luxator Root Elevators

Luxator

DE-174
 Luxator
 3mm
 straight

DE-175
 Luxator
 3mm
 curved

DE-176
 Luxator
 4mm
 straight

DE-177
 Luxator
 4mm
 curved

DE-178
 Luxator
 5mm
 straight

DE-179
 Luxator
 5mm
 curved

Bein Root Elevators

Bein



DE-180
 Bein 2mm

DE-181
 Bein 3mm

DE-182
 Bein 4mm

Seldin Root Elevators

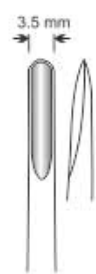
Seldin

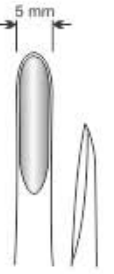
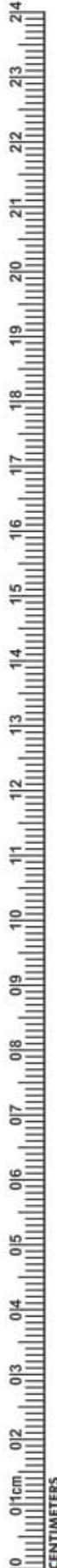

DE-183
 Flohr 1

DE-184
 Seldin 34S

DE-185
 Seldin 34

ROOT ELEVATOR

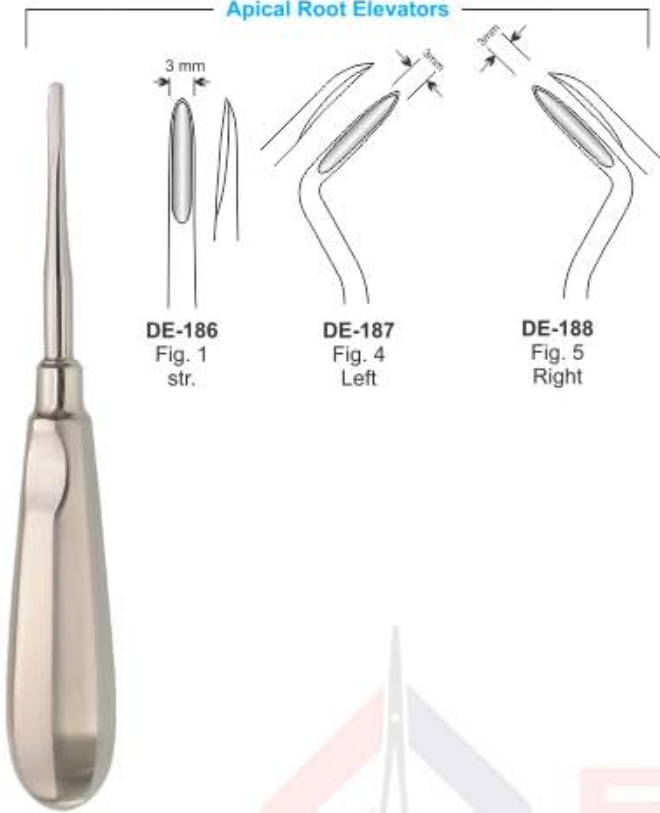
- Элеватор корневой экстракционный
- Elévateurs à racines
- Wurzelheber
- Слеватор корневий экстракційний
- Elevadores para raices
- المصاعد الجذر

Apical Root Elevators



DE-186
Fig. 1
str.

DE-187
Fig. 4
Left

DE-188
Fig. 5
Right

Apical Root Elevators

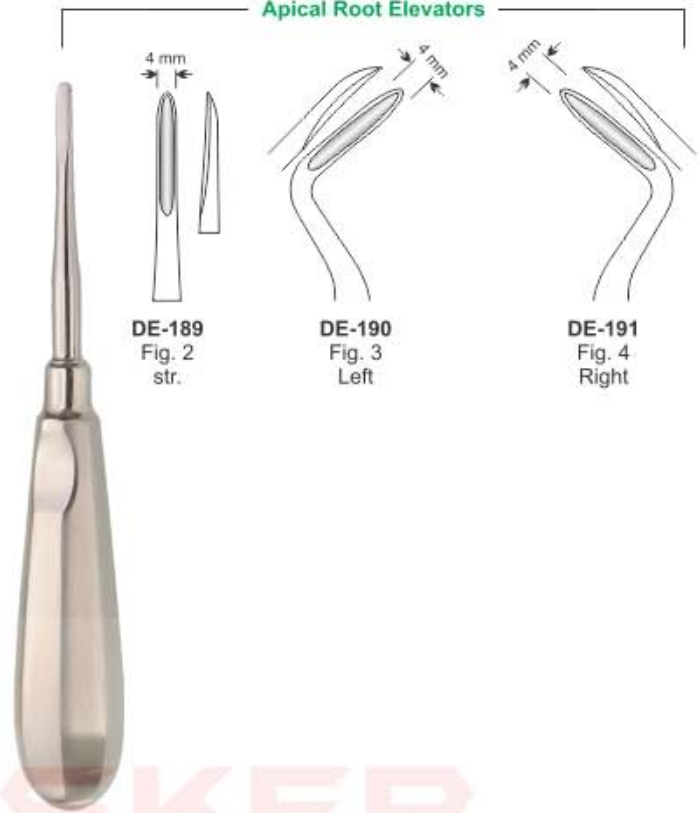

DE-189
Fig. 2
str.

DE-190
Fig. 3
Left

DE-191
Fig. 4
Right

Coupland Root Elevators

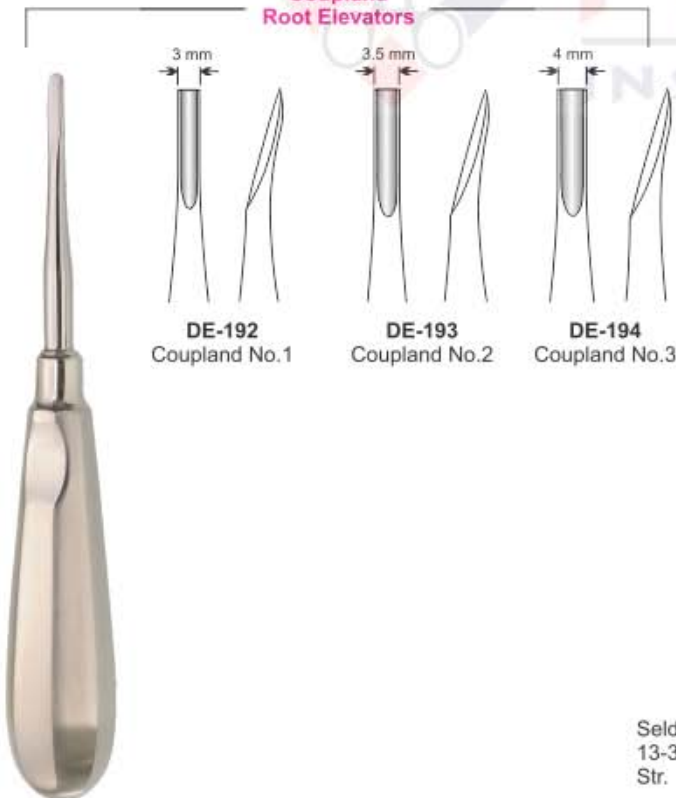

DE-192
Coupland No.1

DE-193
Coupland No.2

DE-194
Coupland No.3

Seldin Root Elevators

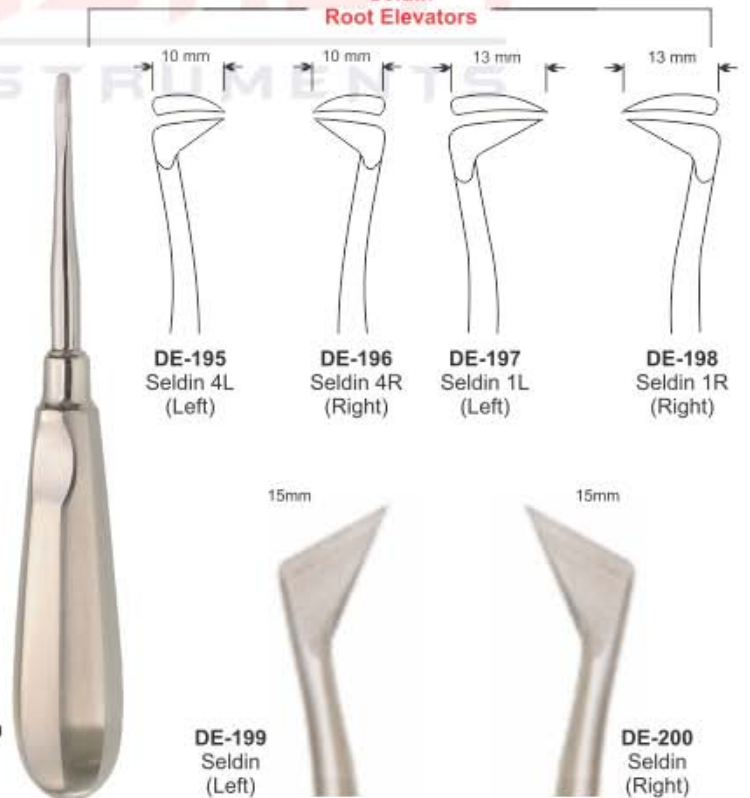

DE-195
Seldin 4L
(Left)

DE-196
Seldin 4R
(Right)

DE-197
Seldin 1L
(Left)

DE-198
Seldin 1R
(Right)

Seldin
13-3
Str.

DE-199
Seldin
(Left)

DE-200
Seldin
(Right)



- Элеватор корневой экстракционный
- Elévateurs à racines
- Wurzelheber

- Єлеватор кореневий екстракційний
- Elevadores para raices
- المصاعد الجذر

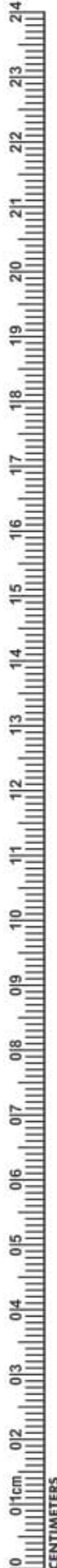

Apical Root Elevators

Apical Root Elevators

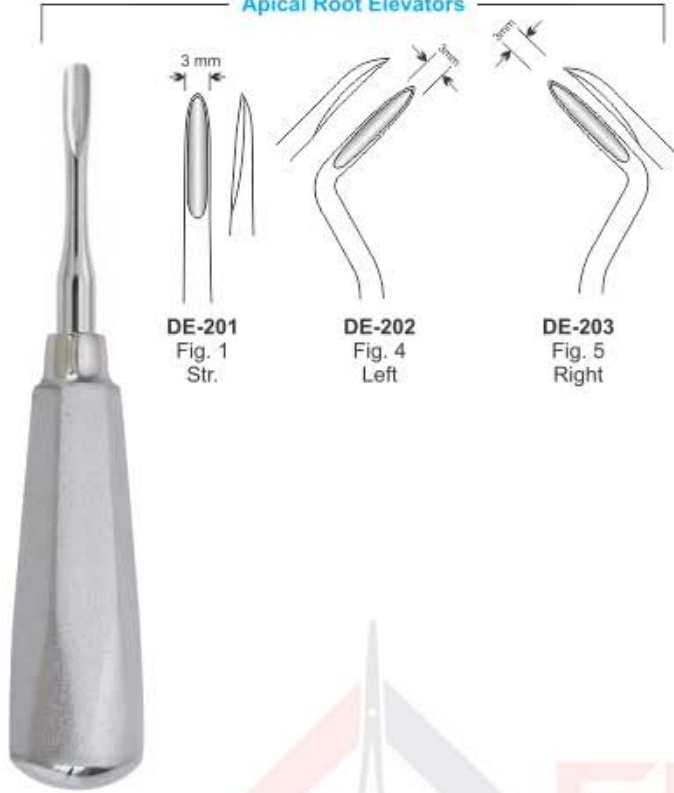

Coupland Root Elevators

Seldin Root Elevators

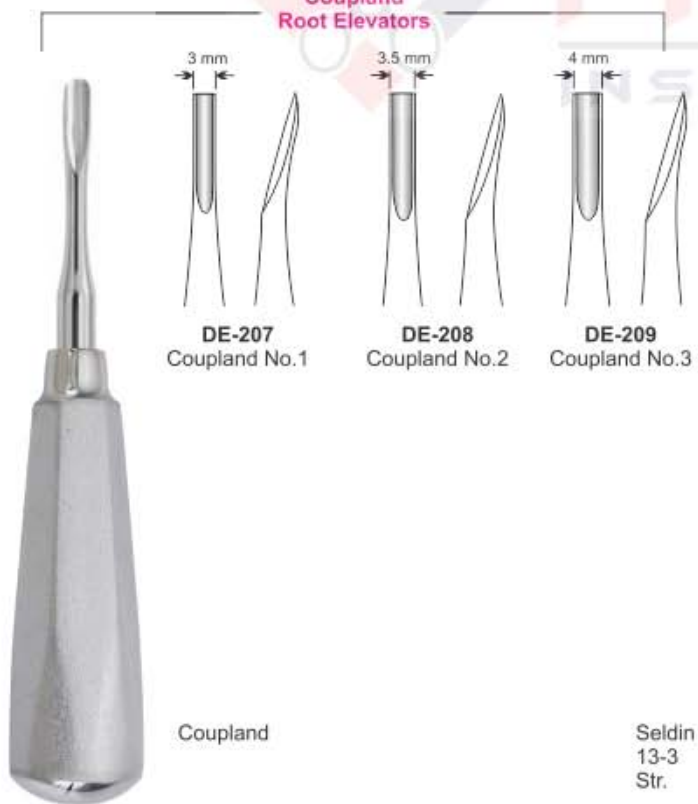

ROOT ELEVATOR

- Элеватор корневой экстракционный
- Elévateurs à racines
- Wurzelheber
- Слеватор корневий екстракційний
- Elevadores para raices
- المصاعد الجذر

Apical Root Elevators

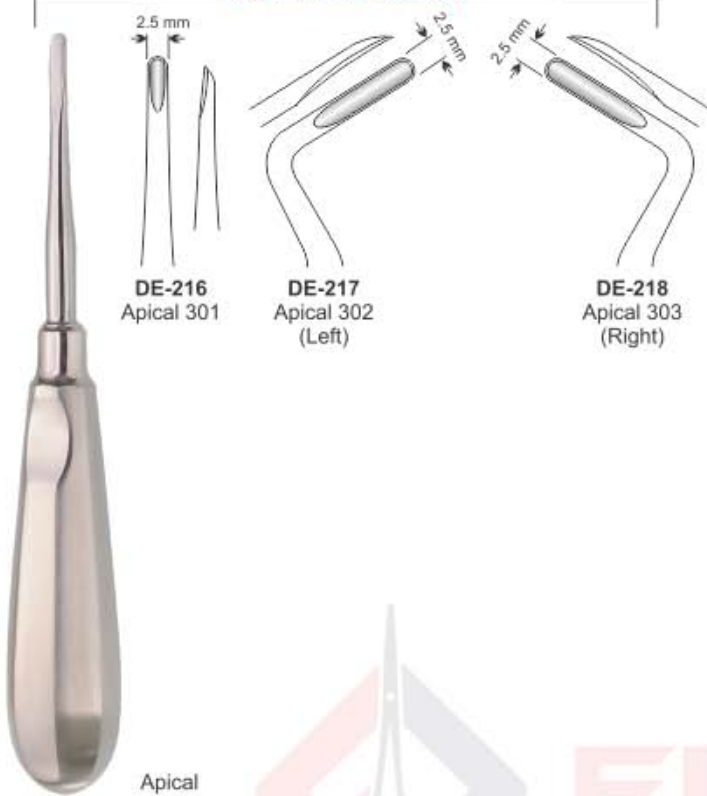

Apical Root Elevators

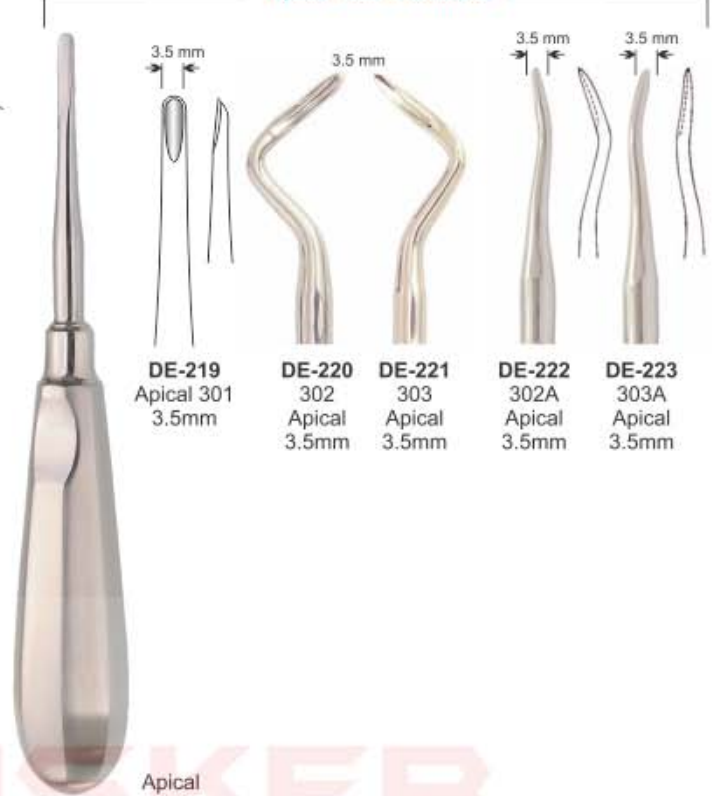

Apical Root Elevators



Laxutor Root Elevators



- Элеватор корневой экстракционный
- **Élévateurs à racines**
- Wurzelheber

- Слеватор корневий экстракційний
- Elevadores para raices
- المصاعد الجذر

Lindo Levian Root Elevators

Flohr Root Elevators
Heidbrink Root Elevators

ROOT ELEVATOR

- Элеватор корневой экстракционный
- Elévateurs à racines
- Wurzelheber
- Слеватор корневий екстракційний
- Elevadores para raices
- المصاعد الجذر

Friedmann Roots Elevator



DE-251
Friedmann 4F
Str.

DE-252
Friedmann 5F
Left

DE-253
Friedmann 6F
Right

Heidbrink Roots Elevator



DE-254
Heidbrink
Straight

DE-255
Heidbrink
Left

DE-256
Heidbrink
Right

Wisdom Roots Elevator



DE-257
Wisdom
for 18 and 38

DE-258
Wisdom
for 28 and 48

Bayonet Roots Elevator Set



DE-259
Left

DE-260
Right

DE-261
bayonet

Luxator Roots Elevator



DE-262
Curved

DE-263
Straight

DE-264
Luxator
Straight

DE-265
Luxator
Curved

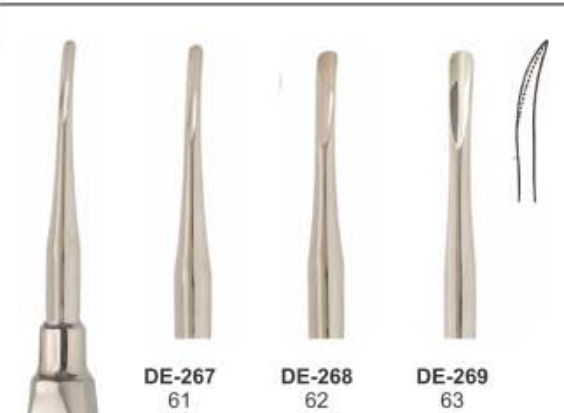

- Элеватор корневой экстракционный
- Elévateurs à racines
- Wurzelheber
- Слеватор корневий екстракційний
- Elevadores para raices
- المصاعد الجذر

Roots Elevator

 DE-267
61

 DE-268
62

 DE-269
63

 DE-266
60

Luxier Roots Elevator

 DE-270
Luxier
3mm, Straight

 DE-271
Luxier
3mm, Curved

 DE-272
Luxier
5mm, Stright

 DE-273
Luxier
3mm, Angular

Luxier Roots Elevator

 DE-274
Luxier
Cvd.

 DE-275
Luxier
Str.

Claw-Lift Roots Elevator

 DE-276
Claw-Lift
Right

 DE-277
Claw-Lift
Left

ROOT ELEVATOR

- Элеватор корневой экстракционный
- Elévateurs à racines
- Wurzelheber
- Слеватор корневий екстракційний
- Elevadores para raices
- المصاعد الجذر

Hyllin Roots Elevator

Cryer Roots Elevator



Kopp Roots Elevator



- Элеватор корневой экстракционный
- Élévateurs à racines
- Wurzelheber

- Elevator cornevier ekstraktsionnyy
- Elevadores para raices
- المصاعد الجذر

Kopp Roots Elevator

DE-295
 Kopp
 Right

DE-296
 Kopp
 Left

Heber Roots Elevator

DE-297
 Heber
 Bayonet

DE-298
 Heber
 Bayonet

Bein Roots Elevator

DE-299
 Bein,
 3mm

DE-300
 Bein,
 4mm

Bein Roots Elevator

DE-301
 Bein
 2mm, curved
 serrated

DE-302
 2mm
 straight
 serrated

DE-303
 3mm
 straight

DE-304
 4mm
 Curved

DE-305
 Bein
 2mm, curved
 serrated

DE-306
 2mm
 straight
 serrated

DE-307
 3mm
 straight

DE-308
 4mm
 Curved

DE-309
 Bein
 2mm, curved
 serrated

DE-310
 2mm
 straight
 serrated

DE-311
 3mm
 straight

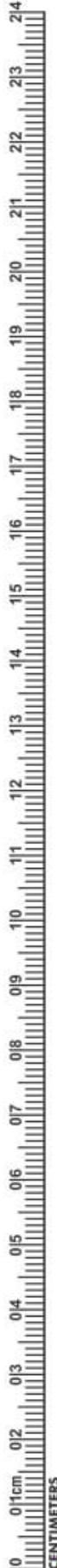
DE-312
 4mm
 Curved

ROOT ELEVATOR

- Элеватор корневой экстракционный
- Elévateurs à racines
- Wurzelheber
- Слеватор корневий екстракційний
- Elevadores para raices
- المصاعد الجذر

Seldin Roots Elevator



W. Barry Roots Elevator



Winter Roots Elevator



Pott Roots Elevator



- Элеватор корневой экстракционный
- Elévateurs à racines
- Wurzelheber

- Слеватор корневий екстракційний
- Elevadores para raices
- المصاعد الجذر

Heidbrink Roots Elevator

DE-338
 Heidbrink
 Straight

DE-339
 Heidbrink
 Left

DE-340
 Heidbrink
 Right

DE-341
 Heidbrink
 Straight

DE-342
 Heidbrink
 Left

DE-343
 Heidbrink
 Right

Syndesmotomes Roots Elevator

DE-344
 Straight

DE-345
 Left

DE-346
 Right

Periotome Roots Elevator

Syndesmotomes

DE-347
 Periotome
 2.1mm
 Straight

DE-348
 Periotome
 2.6mm
 Straight

DE-349
 Periotome
 2.1mm
 Angular

DE-350
 Periotome
 2mm
 Curved

DE-351
 Periotome
 2.0mm

DE-352
 Periotome
 2.5mm

DE-353
 Periotome
 3.0mm

DE-354
 Periotome
 4.0mm

ROOT ELEVATOR

- Элеватор корневой экстракционный
- Elévateurs à racines
- Wurzelheber
- Слеватор корневий екстракційний
- Elevadores para raices
- المصاعد الجذر



DE-355
1S
(Straight 1mm)



DE-356
2S
(Straight 2mm)



DE-357
3S
(Straight 3mm)



DE-358
5S
(Straight 5mm)



DE-359
3C
(Curved 3mm)



DE-360
5C
(Curved 5mm)



DE-361
3CA
(Curved Angle 3mm)



DE-362
3IC
(Inverted Curved 3mm)



DE-363
DE 3
(Dual Edge 3mm / 1.5mm)



DE-364
DE 5
(Dual Edge 5mm / 3mm)



- Элеватор корневой экстракционный
 - **Elévateurs à racines**
 - Wurzelheber
- PDL ELEVATORS**

- Слеватор корневий екстракційний
- Elevadores para raices
- المصاعد الجذر

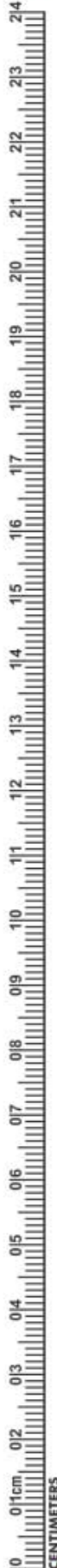

Distal, 2.5mm
Micro Edge

Mesial, 2.5mm
Micro Edge

Distal, 4mm
Micro Edge

Mesial, 4mm
Micro Edge

2.5mm
Micro Edge, curved

2.5mm
Micro Edge, Straight

3.4mm
Straight

DE-365
PDL Elevators
Set of 7 Pcs



Distal, 4mm
Micro Edge

Mesial, 4mm
Micro Edge

Distal, 2.5mm
Micro Edge

Mesial, 2.5mm
Micro Edge

2.5mm
Micro Edge, curved

2.5mm
Micro Edge, Straight

3.4mm
Straight

DE-366
PDL Elevators
Set of 7 Pcs

ROOT ELEVATOR

- Элеватор корневой экстракционный
- Elévateurs à racines
- Wurzelheber
- Слеватор корневий екстракційний
- Elevadores para raíces
- المصاعد الجذر

PDL ELEVATORS

Delicate Arrow tip



4,0mm straight
4,0mm curved

Luxivators straight
atraumatic luxation of the tooth



2,5mm straight
3,5mm straight
4,5mm straight

Luxivators curved
atraumatic luxation of the tooth



2,5mm curved
3,5mm curved
4,5mm curved



DE-367
PDL Elevators
Set of 8 Pcs



Our Scalers

Compare our scalers and curettes with the best in the industry and you will immediately recognize we are equal in every way but one... price. Note the deep precision knurling for better tactile feel. The same high-grade stainless steel tips, the same light weight (under 18 grams) for less hand fatigue, the same professional craftsmanship, and surpassing the highest industry standards. of course, any manufacturer can make these claims, but we guarantee and certify ours.

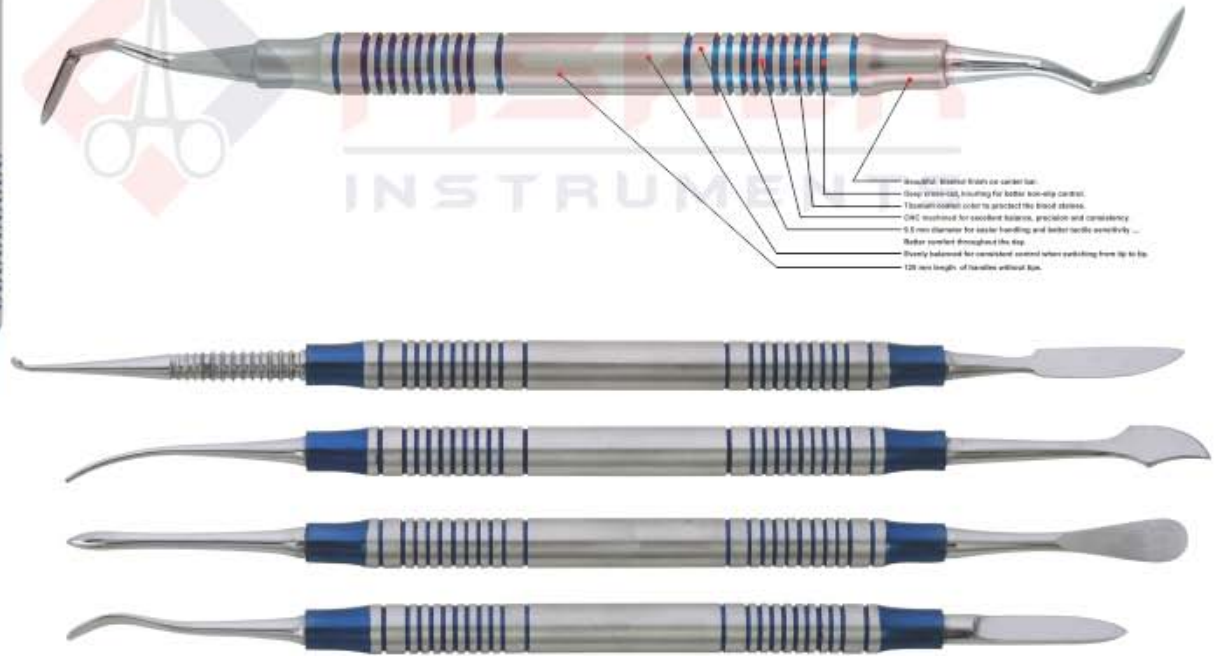
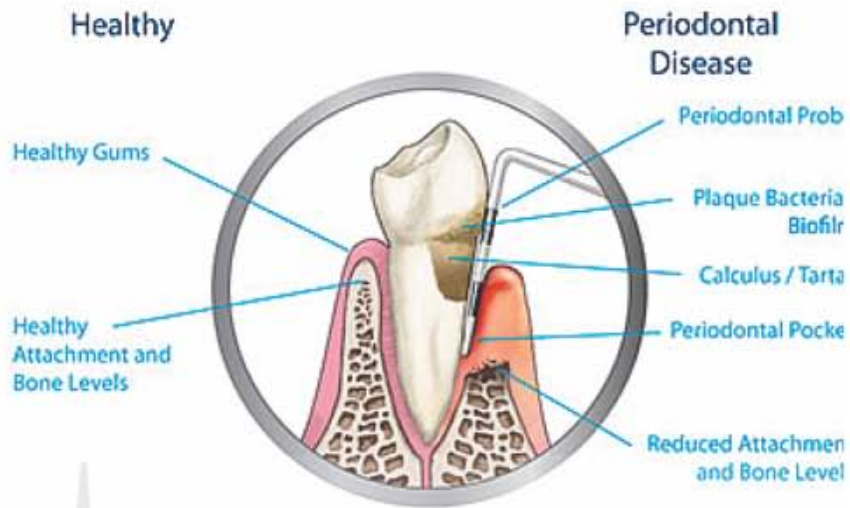
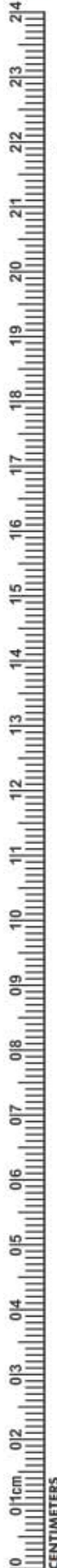

• straight, blade from occlusal face
 • deep (1000-105) knurling for better non-slip control
 • fluorinated coating color to protect the blood stream
 • CNC machined for excellent balance, precision and consistency
 • 0.5 mm diameter for easier handling and better tactile sensitivity ...
 • Rubber spacers throughout the tip
 • Dually balanced for consistent control when switching from tip to tip
 • 120 mm length of handles without tip.

- High-polish mirror finish tips.
- Manufactured within the guidelines of the FDA quality assurance system for good manufacturing practices.
- Highest grade German stainless steel, razor sharp, durable tips. Rockwell hardened to 60 RHc.
- 27 of the most popular designs from graceys to McCalls to cumbias, and many european patterns.
- All instruments are guaranteed against defects in material and workmanship.

- All instruments bear the ce mark, emblematic of the european community's highest standards.
- Customer satisfaction guarantee, too!
- Less than 20 grams ... Lightweight for less hand fatigue.
- Manufactured to the most exacting standards so the 50th instrument you buy is exactly like your first.
- You decide ... Why pay more for the same high-quality instruments?

HANDLES FOR MOUTH MIRRORS

- Ручки для зеркал
- Manches pour miroirs à bouche
- Mundspiegelgriffe
- Ручки для дзеркал
- Mangos para espejos de boca
- مقابض لمرآيا الفم



Magnifying



DE-368
Fig. 3
Ø20 mm

DE-369
Fig. 4
Ø22 mm

DE-370
Fig. 5
Ø24 mm

Plain

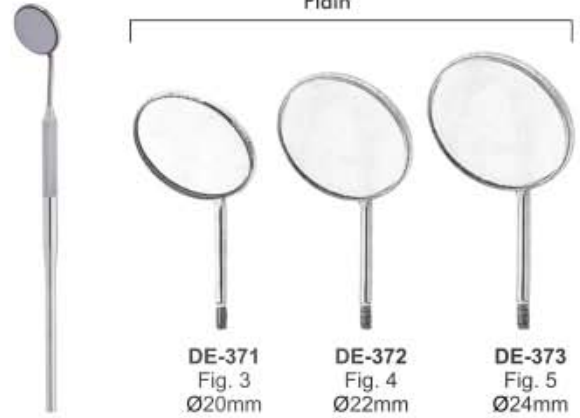

DE-371
Fig. 3
Ø20mm

DE-372
Fig. 4
Ø22mm

DE-373
Fig. 5
Ø24mm



Rhodium

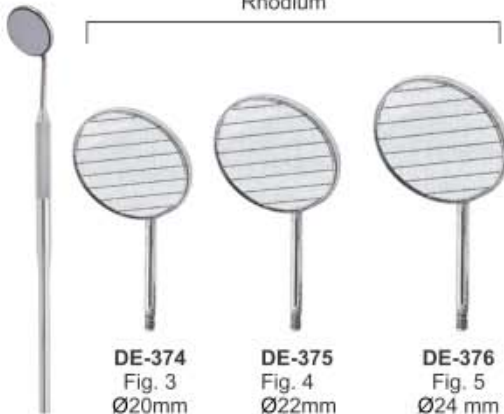

DE-374
Fig. 3
Ø20mm

DE-375
Fig. 4
Ø22mm

DE-376
Fig. 5
Ø24 mm



DE-377 Hollow Mirror Handle Stem Extra Light (7.5mm) Length 5"



DE-378 Mirror Handle Stem Octagonal (6mm) Length 5"



DE-379 Mirror Handle Stem Round (6mm) Length 5"



DE1-380 Solid 12cm



DE2-380 Solid



DE3-380 Mirror Handle Stem with Rule 35mm (6mm) Length 5"



DE-380 Mirror Handle Stem with Rule 35mm (6mm) Length 5"



- Пинцеты
- Pincettes - Brucelles
- Zahnpinzetten

- Пинцети
- Pinzas para algodón
- ملاقط



DE-381
Surgical
11.5cm



DE-382
London College
15cm



DE-383
Semken Taylor
Str.



DE-384
Semken Taylor
Cvd.



DE-385
Meriam
16cm



DE-386
Dressing
14cm



DE-387
Semken Taylor
1x2 Straight



DE-388
Semken Taylor
1x2 Curved



DE-389
Gilles
15cm 1x2



DE-390
14cm 1x2



DE-391
Perry
13cm



DE-392
Atraumatic
15cm Cvd



DE-393
Atraumatic
15cm Str.



DE-394
College with Lock
15cm Cvd.



DE-395
Gerald
17.5cm



DE-396
with lock
15cm



DE-397
Atraumatic
17.5cm



FISHER
INSTRUMENTS

TWEEZERS

- Пинцеты
- Prêcelles - Brucelles
- Zahnpinzetten
- Пинцети
- Pinzas para algodón
- ملاقط



DE-398
Adson-TC
12cm



DE-399
Adson-TC
12cm 1x2



DE-400
Adson-TC
15cm 1x2



DE-401
Adson
12cm



DE-402
Adson
12cm 1x2



DE-403
Adson
15cm 1x2



DE-404
Adson Brown
12cm



DE-405
Crane Kaplan
15cm



DE-406
Crane Kaplan
15cm



DE-407
Crane Kaplan
15cm



DE-408
Hemingway
15cm



DE-409
Miller
15cm Str.



DE-410
Miller
15cm Cvd.



DE-411
Dressing
Tweezer
14.5cm



DE-412
College
Curved
Tip 15cm



DE-413
Maryam
Tweezers
15cm



DE-414
College
Tweezer
15cm



DE-415
Perry
Tweezer
12.5cm



DE-416
Self-locking
Tweezer
15cm



- Зонды
- Sondas
- Zahnsonden
- Зонди
- Sondas
- المستكشفين

Single Ended Probe Solid Handle 4.5mm Length 150mm

 Fig. 2
 Normal Handle

 DE-416
 Fig. 2

 DE-417
 Fig. 23

 DE-418
 Fig. 9

 DE-419
 Fig. 16

 DE-420
 Fig. 11

 DE-421
 Fig. 03

 DE-422
 Fig. 3A

 DE-423
 Fig. 5

 DE-424
 Fig. 6

 DE-425
 Fig. 8A

 DE-426
 Fig. 10

 DE-427
 Fig. 12

 DE-428
 Fig. 17

 DE-429
 Fig. 17A

Single Ended Probe Hollow Handle 8.5mm Length 150mm

 Fig. 2
 Anatomic Handle

 DE-430
 Fig. 2

 DE-431
 Fig. 23

 DE-432
 Fig. 9

 DE-433
 Fig. 16

 DE-434
 Fig. 11

 DE-435
 Fig. 03

 DE-436
 Fig. 3A

 DE-437
 Fig. 5

 DE-438
 Fig. 6

 DE-439
 Fig. 8

 DE-440
 Fig. 8A

 DE-441
 Fig. 10

 DE-442
 Fig. 12

 DE-443
 Fig. 17

 DE-444
 Fig. 17A

EXPLORERS

- Зонды
- Sondes
- Zahnsonden
- Зонди
- Sondas
- المستكشفين

Probes Single End Solid Handle 6mm, length 150mm



DE-445 Fig. 6 DE-446 Fig. 8 DE-447 Fig. 9 DE-448 Fig. 16 DE-449 Fig. 23

Probes Single Ended 6mm, length 150mm

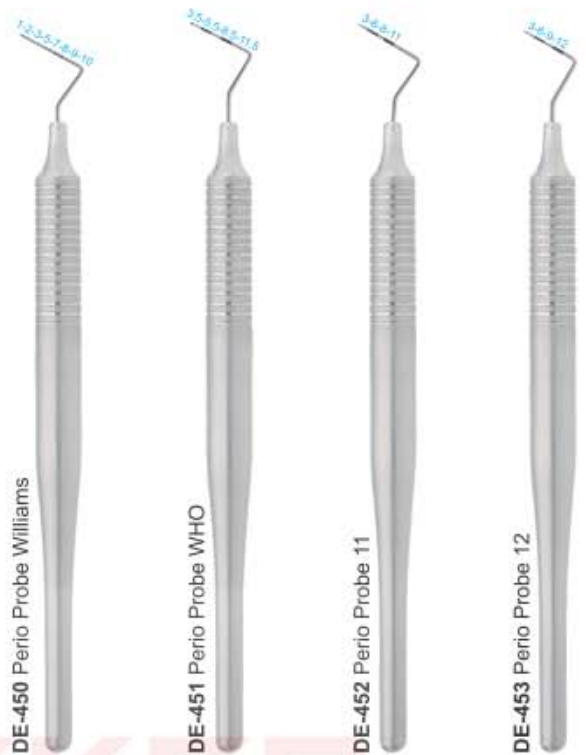

DE-450 Perio Probe Williams DE-451 Perio Probe WHO DE-452 Perio Probe 11 DE-453 Perio Probe 12

Examination kit Set of 3 Pieces



DE-454 Probe DE-455 Mirror DE-456 College Forcep 15cm

Examination Set of 4 Pieces



Examination Set of 4 Pieces



DE-457 Exp,23/17-A DE-458 Exavators DE-459 Tweezers DE-460 Mouth Mirror



EXPLORERS INSTRUMENTS SOLID HANDLE 6MM, LENGTH 170MM

- Зонды
 - Sondas
 - Zahnsonden
- Зонди
 - Sondas
 - المستكشفين

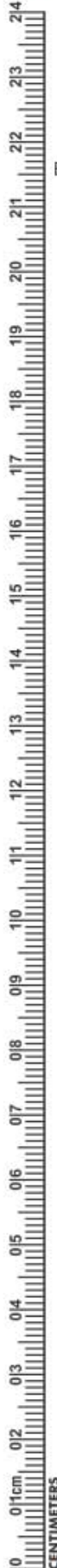

Explorers-Single-End

Double-Ended Explorers

EXPLORERS

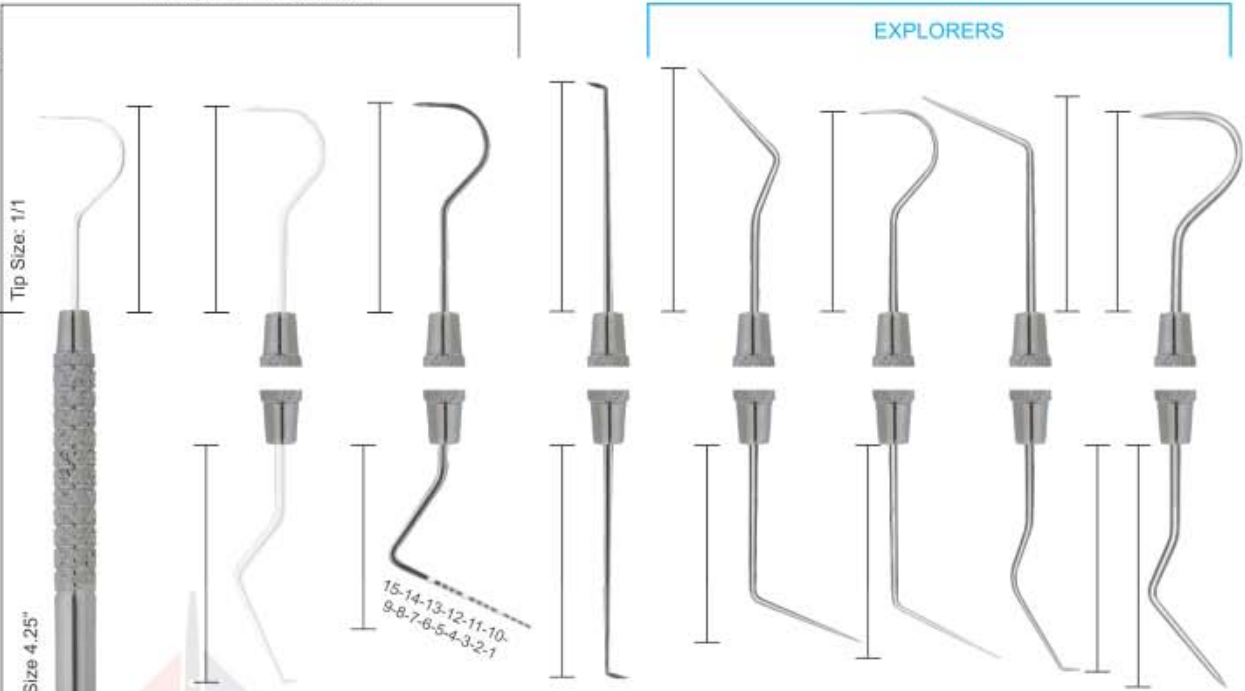

Tip Size: 1/1

Solid Handle Size 4.25"

15-14-13-12-11-10-9-8-7-6-5-4-3-2-1

DE-463
TU 17/23
Wilkins/Tufts
Explorer
#6

DE-464
23/UNC1
university of north
carolina
Explorer #31, #6, #7, #8

DE-465
1
#31, #6

DE-466
DG 16
#31, #6, #7
Thick, #6

DE-467
DG 16/23

DE-468
DG 16/17

DE-469
1
Abou-Rass
Explorers

Probes Double Ended 6mm, length 170mm



DE-461
23
Shepherd's
Hook
Explorer
#30, #6, #7, #8

DE-462
#5, #6
Explorer

DE-470
Goldman Fox
Fig.17

DE-471
University
of Michigan
Fig.17

DE-472
Williams
Fig.17

DE-473
Goldman Fox
Fig.16

DE-474
University
of Michigan
Fig.16

DE-475
Williams
Fig.16

EXPLORERS

- Зонды
- Sondes
- Zahnsonden
- Зонди
- Sondas
- المستكشفين

Pointed Probes Single Ended Handle 6mm, length 150mm

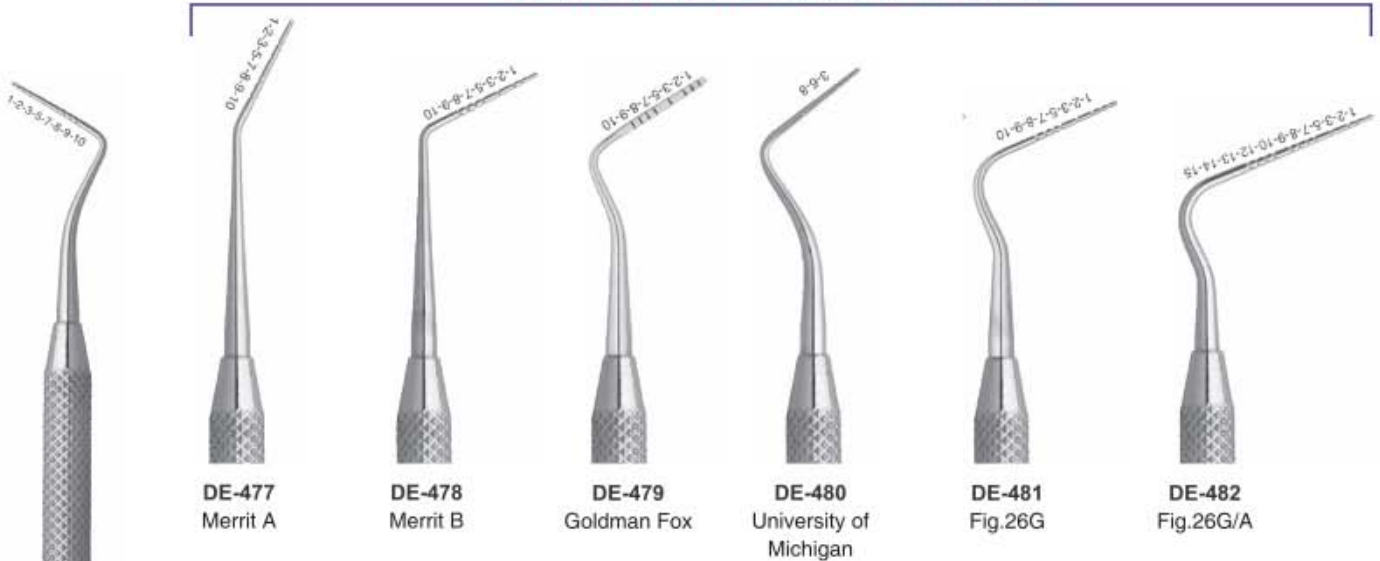

Pointed Probes Double Ended Handle 6mm, length 170mm



- Инструменты пародонтологические
- Instruments pour la parodontologie
- Instrumente für die Parodontologie

- Інструменти пародонтологічні
- instrumentos para periodoncia
- الصكوك اللثة

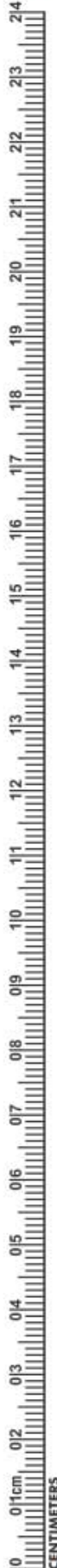
PERIODONTAL SET OF 10 PIECES SOLID HANDLE 6MM LENGTH 170MM

DE-488 MOUTH MIRROR



DE-489 EXP,23/17-A



DE-490 EXAVATORS



DE-491 Filling Instruments



DE-492 EXP,23/CP-18



DE-493 EXP,23/CP-QW



DE-494 EXP,23/CP-11



DE-495 EXP,23/CP-10



DE-496 EXP,23/CP-12



DE-497 EXP,23/CP-11.5-B

CURETTES

- Кюрети
- Curetas
- Küretten
- Кюрети
- Curette
- كرتس

SICKLE SCALERS

Designed for the removal of supragingival calculus



D1-001
H6/H7
Hygienist

D1-002
H5/33
Hygienist-
Jacquette

D1-003
H5/U15
Hygienist-
Towner

D1-004
6/7
Goldman

D1-005
U15
Towner

D1-006
U15/30
Towner-
Jacquette

D1-007
U15/33
Towner-
Jacquette



CURETTES

- Кюрети
- Curetas
- Küretten
- Кюрети
- Curette
- كرتس

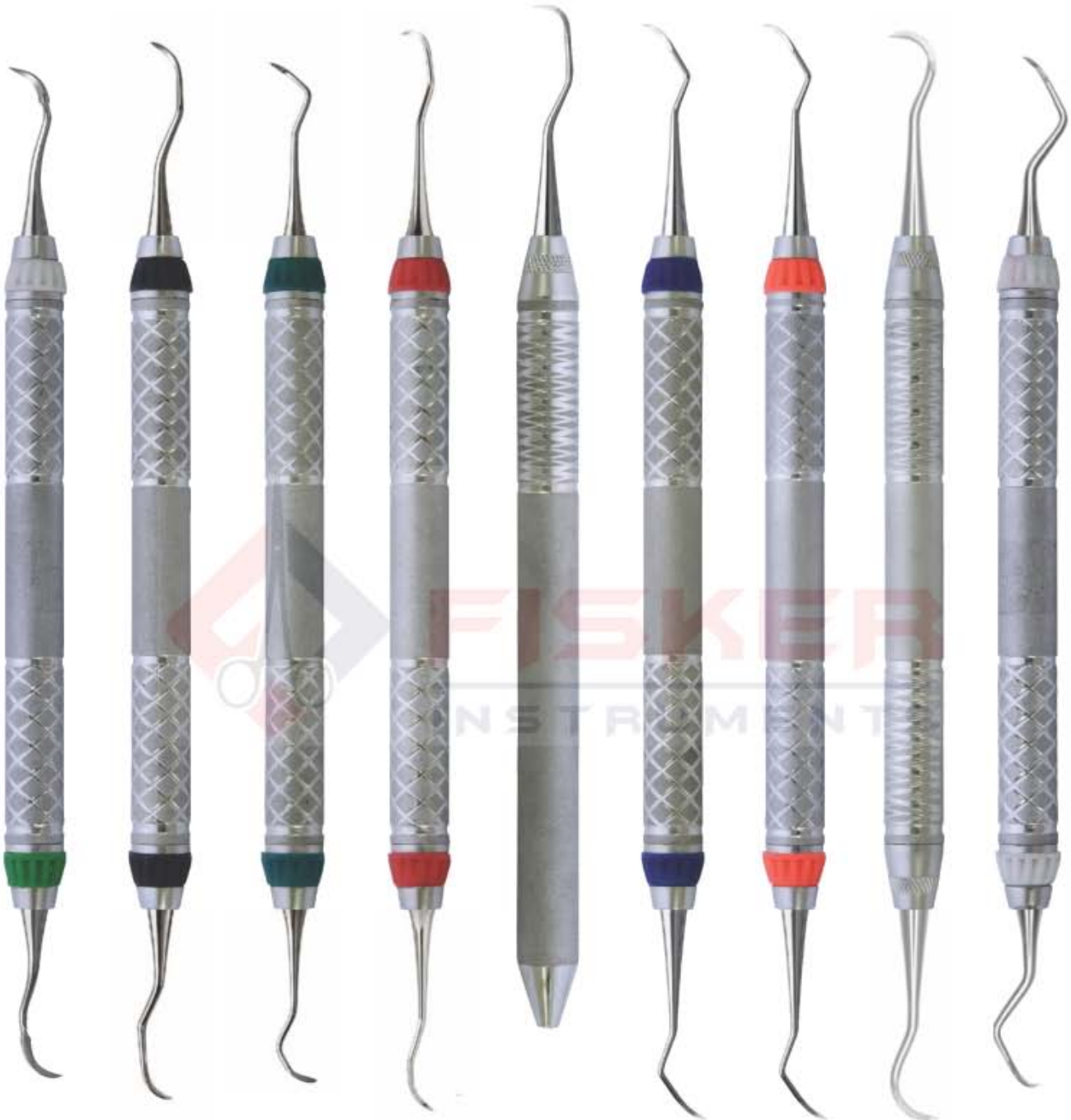

D1-018
204

D1-019
204
IUFW

D1-020
204S

D1-021
204SD

D1-022
1
Springfield
Anterior

D1-023
2/3
Springfield

D1-024
2/3
Springfield

D1-025
J1/2
Johnson

D1-026
Sickel-Scaler
Posterior

- Кюрети
- Curetas
- Küretten
- Кюрети
- Curette
- کرتس

SICKLE SCALERS

POSTERIOR

ANTERIOR



D1-027
135



D1-028
REM 3/4
Remington



D1-029
129



D1-030
T2/T3
Taylor



D1-031
137



D1-032
0/00
Morse



CURETTES

- Кюрети
- Curetas
- Küretten
- Кюрети
- Curette
- كرتس



D1-033
137
Mini Five



D1-034
OD1/33
Odont/
Jacquette



D1-035
128
Nebraska



D1-036
USC-128



D1-037
WH-2
Whiteside



D1-038
YG-15
Younger-
Good



INCHES

- Кюрети
- Curetas
- Küretten
- Кюрети
- Curette
- کرتس

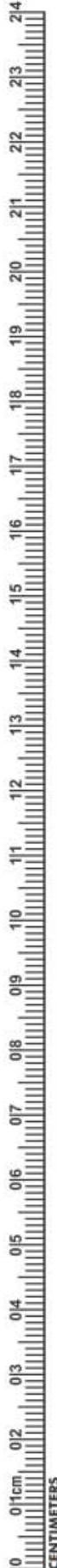

BALL SCALERS

CRANE-KAPLAN



D1-039
CI-1

D1-040
CI-2/3

D1-041
152
Cumine

D1-042
B-1

D1-043
B-4

D1-044
B-2/3

D1-045
B-5/6

D1-046
CK-6

D1-047
CK-6D

D1-048
333/334
Mini Kaplan

CURETTES

- Кюрети
- Curetas
- Küretten
- Кюрети
- Curette
- كرتس

SCALER / CURETTE SETS

Mc CALL SET

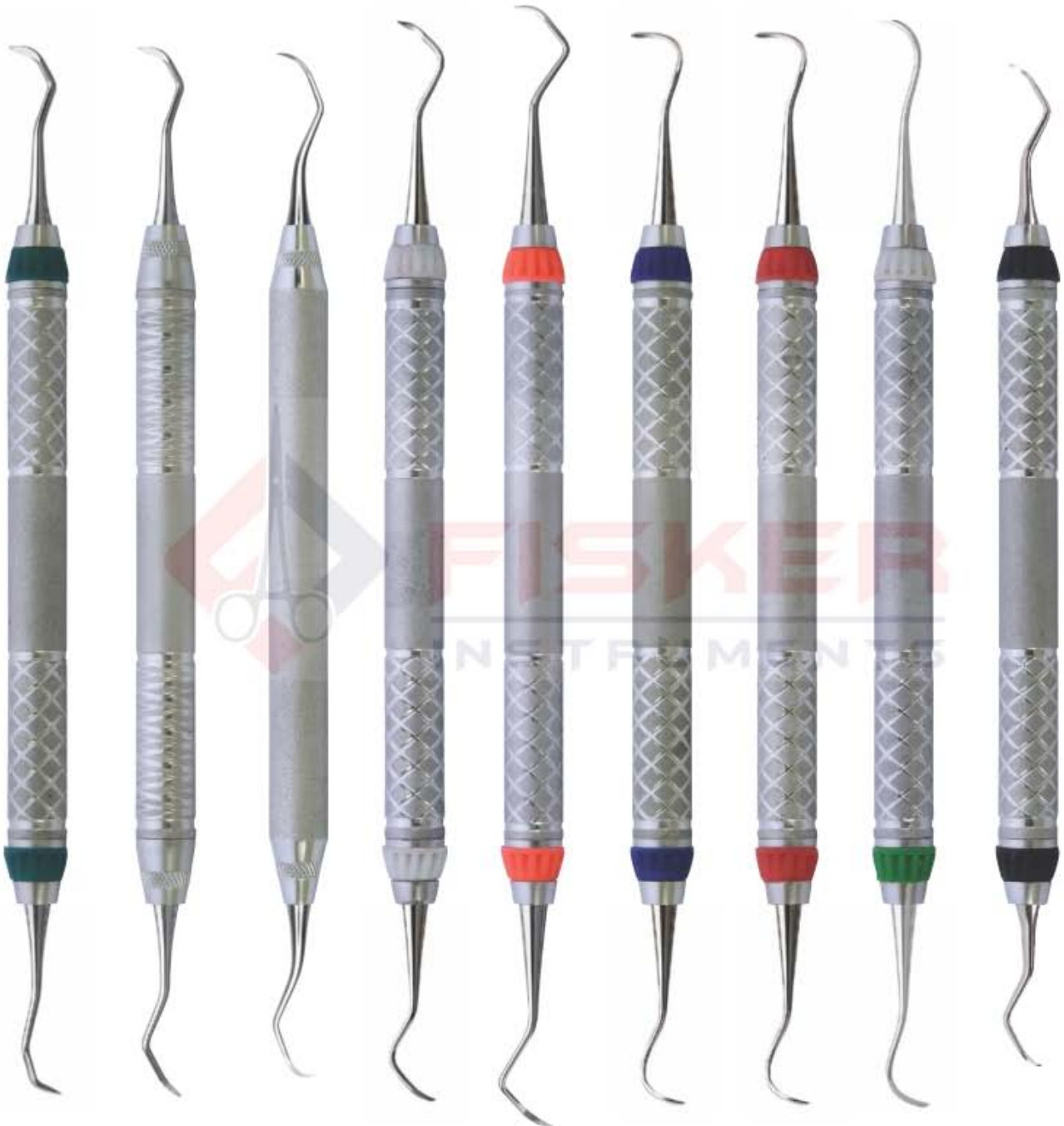

D1-049
11/12
Scaler

D1-050
11A/12A
Scaler

D1-051
11/12S
Modified
McCall

D1-052
13S/14S
Pointed
Curette

D1-053
MTC 13/14
Pointed
Curette

D1-054
17/18
Curette

D1-055
17S/18PT
Curette

D1-056
19/20
Curette

D1-057
Goldman-Fox

- Кюрети
- Curetas
- Kuretten
- Кюрети
- Curette
- کرتس

SCALER / CURETTE SETS
GOLDMAN-FOX SET

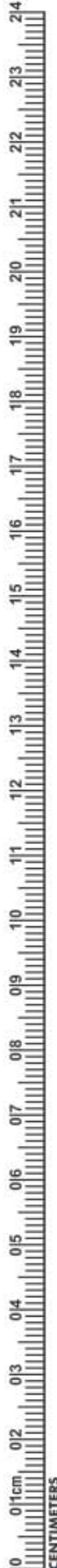

D1-058
GF-1
Universal Scaler

D1-059
GF-2
Curette

D1-060
GF-3
Curette

D1-061
GF-4
Curette

D1-062
GF-5 Hoe
Buccal/Lingual

D1-063
GF-6
Hoe

D1-064
GF-21
Curette

D1-065
GF-21S/33
Combination

CURETTES

- Кюрети
- Curetas
- Küretten
- Кюрети
- Curette
- كرتس

SCALER / CURETTE SETS

GOLDMAN-FOX SET

CATTONI SET

COLUMBIA



D1-066
103/106

D1-067
104/105
Hoe/Chisel

D1-068
112/113

D1-069
107/108

D1-070
107/108S
Modified

D1-071
2R/2L
Columbia

D1-072
4R/4L
Columbia

D1-073
13/14
Columbia (shown)

D1-074
13/14
Columbia Rigid

D1-075
13/14
Columbia
Curved Tip

- Кюрети
- Curetas
- Küretten
- Кюрети
- Curette
- كرتس

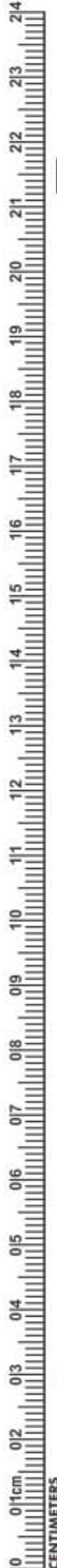
UNIVERSAL CURETTES
BARNHART

D1-076
 IU13/14 Indiana University Anterior

D1-077
 IU17/18 Indiana University Posterior

D1-078
 1/2 Bunting Curette-Chisel combination

D1-079
 5/6 Bunting

D1-080
 YG7/8 Younger-Good

D1-081
 1/2 Barnhart (shown)

D1-082
 1/2 Barnhart Rigid

D1-083
 5/6 Barnhart (shown)

D1-084
 5/6 Barnhart Rigid

CURETTES

- Кюрети
- Curetas
- Küretten
- Кюрети
- Curette
- کرتس



D1-085 1/2 (shown) D1-086 1/2 Rigid



D1-087 3/4 (shown) D1-088 3/4 Rigid



D1-089 5/6 (shown) D1-090 5/6 Rigid D1-091 5/6 Extra Rigid



D1-092 7/8 (shown) D1-093 7/8 Rigid D1-094 7/8 Extra Rigid



GRACEY 1/2



GRACEY 7/8



GRACEY 11/12



GRACEY 13/14



GRACEY 15/16



GRACEY 17/18



D1-095 9/10 (shown) D1-096 9/10 Rigid



D1-097 11/12 (shown) D1-098 11/12 Rigid D1-099 11/12 Extra Rigid



D1-100 13/14 (shown) D1-101 13/14 Rigid D1-102 13/14 Extra Rigid



D1-103 15/16 (shown) D1-104 15/16 Rigid



D1-105 17/18 (shown) D1-106 17/18 Rigid



- Кюрети
- Curetas
- Küretten
- Кюрети
- Curette
- کرتس

GRACEY CURETTES

MICRO MINI

GRACEY PROPHY CURETTES

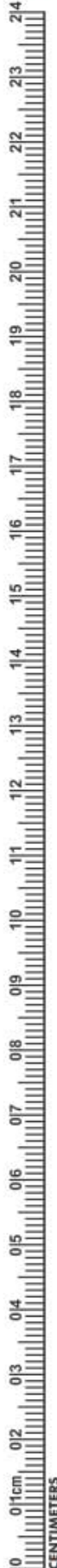

D1-107
Micro Mini
Five 1/2

D1-108
Micro Mini
Five 7/8

D1-109
Micro Mini
Five 11/12

D1-110
Micro Mini
Five 13/14

D1-111
P1/2

D1-112
P3/4

D1-113
P5/6

D1-114
P7/8

EXPLORERS

- Зонды
- Sondes
- Zahnsonden
- Зонди
- Sondas
- المستكشفين

WILLIAM PROBE SET DOUBLE ENDED WITH HOLLOW HANDLE 9.5MM, LENGTH 170MM
CERAMIC COATED HANDLE

Proper care must be given during cleaning, sharpening and sterilization to preserve design and integrity and to prolong usefulness. Do not expose instruments to sterilization temperatures above 350 F/177 C or to higher than recommended chemical concentrations.

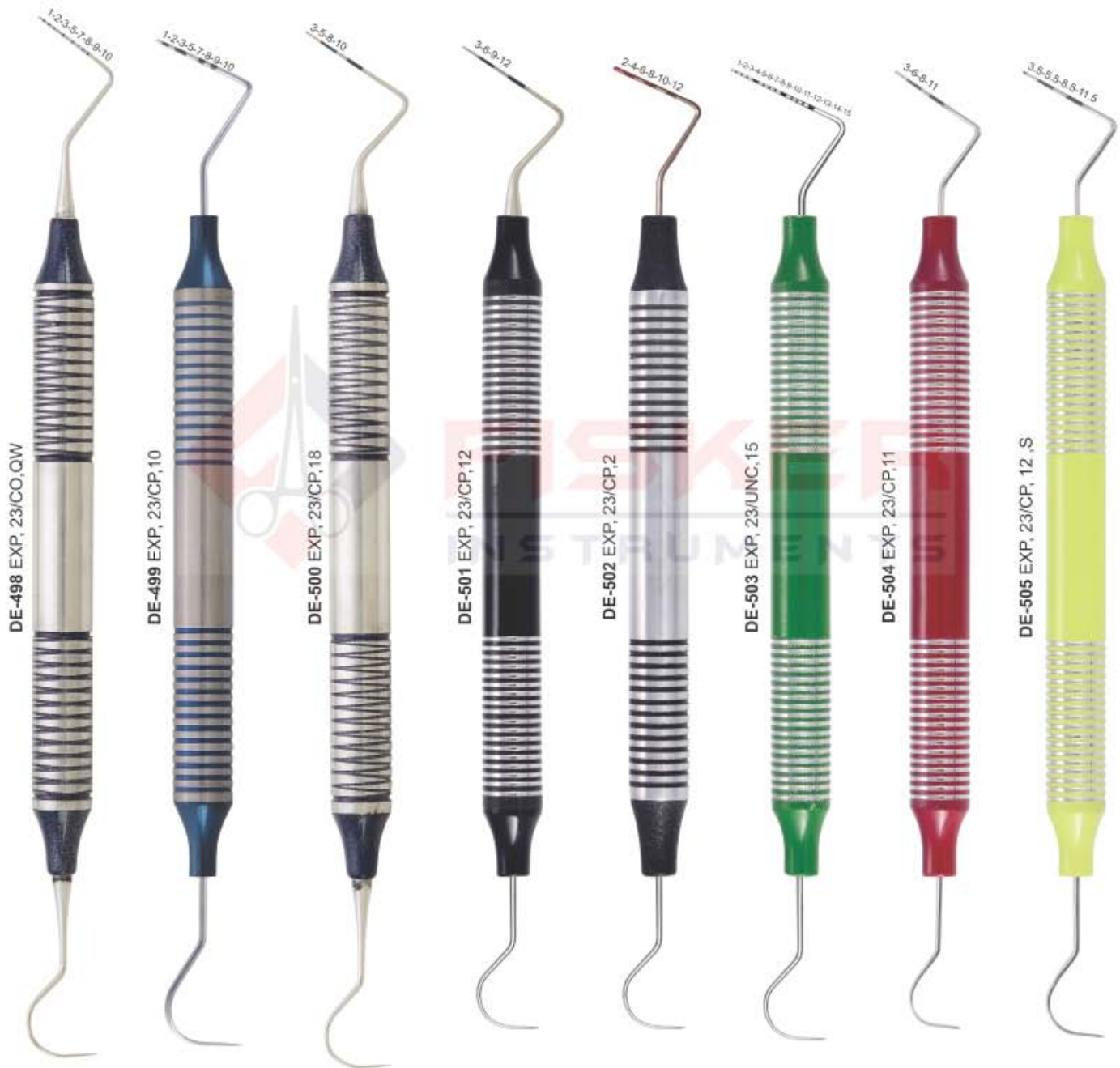

- Кюрети
- Curetas
- Küretten
- Кюрети
- Curette
- کرتس

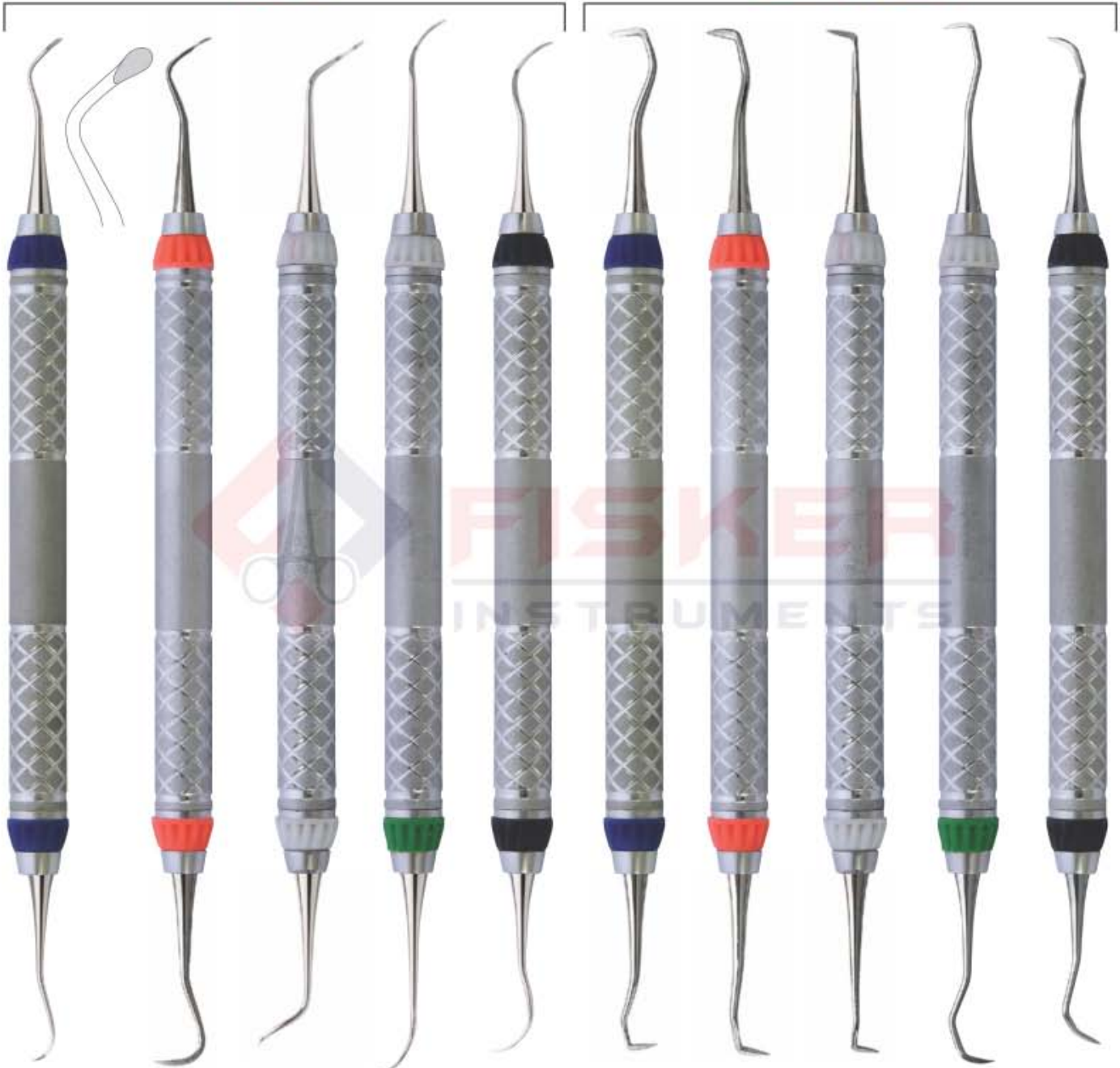
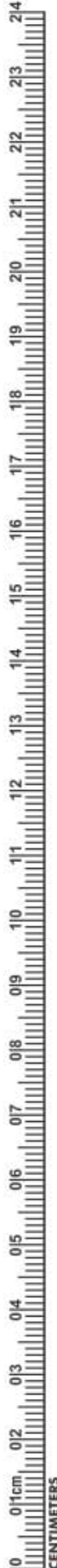
SCALERS
JACQUETTE SCALERS

D1-008 Nevi 1 Anterior	D1-009 Nevi 1/H5 Anterior	D1-010 Nevi 2 Posterior	D1-011 Nevi 3 Posterior	D1-012 Nevi 4 Posterior	D1-013 30/33 Jacquette	D1-014 31/32 Jacquette	D1-015 34/35 Jacquette	D1-016 H3/H4 Jacquette	D1-017 14/15 Posterior
-------------------------------------	--	--------------------------------------	--------------------------------------	--------------------------------------	-------------------------------------	-------------------------------------	-------------------------------------	-------------------------------------	-------------------------------------

- Инструменты пародонтологические
- Instruments pour la parodontologie
- Instrumente für die Parodontologie

- Інструменти пародонтологічні
- instrumentos para periodoncia
- الصكوك اللثة

**PERIODONTAL INSTRUMENTS SET OF 11 PCS
 SOLID HANDLE 6MM, LENGTH 170MM**

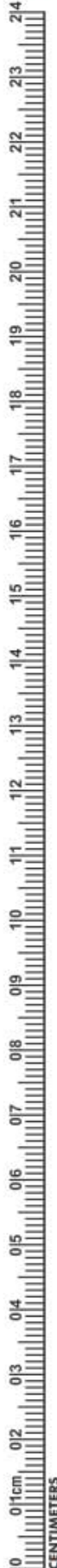

DE-506 Tweezer 125mm

DE-507 Dental Mirror

DE-508 Excavator

DE-509 Heidmann

DE-510 Gracey

DE-511 Filling Ins

DE-512 Hollanback

DE-513 Plugger

DE-514 Sickle

DE-515 Explorer

DE-516 Cutting Ins

125MM

CURETTES

- Кюрети
- Curetas
- Küretten
- Кюрети
- Curette
- كرتس

GRACEY SET OF 7 PCS HOLLOW HANDLE 9.5MM, LENGTH 170MM



DE-517
GRACEY
1/2

DE-518
GRACEY
3/4

DE-519
GRACEY
5/6

DE-520
GRACEY
7/8

DE-521
GRACEY
9/10

DE-522
GRACEY
11/12

DE-523
GRACEY
13/14



- Кюрети
- Curetas
- Küretten
- Кюрети
- Curette
- كرتس

GRACEY SET OF 7 PCS
HOLLOW HANDLE 9.5MM, LENGTH 170MM WITH SILICON GRIP

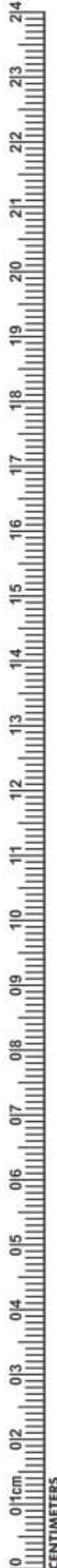

DE-524
 GRACEY
 1/2

DE-525
 GRACEY
 3/4

DE-526
 GRACEY
 5/6

DE-527
 GRACEY
 7/8

DE-528
 GRACEY
 9/10

DE-529
 GRACEY
 11/12

DE-530
 GRACEY
 13/14

CURETTES

- Кюрети
- Curetas
- Küretten
- Кюрети
- Curette
- كرتس

GRACEY MINI FIVE

HOLLOW HANDLE 9.5MM, LENGTH 170MM
CERAMIC COATED HANDLE



DE-531	DE-532	DE-533	DE-534	DE-535	DE-536
Gracey	Gracey	Gracey	Gracey	Gracey	Gracey
1/2	3/4	5/6	7/8	11/12	13/14

GRACEY AFTER FIVE

HOLLOW HANDLE 9.5MM, LENGTH 170MM
CERAMIC COATED HANDLE



DE-537	DE-538	DE-539	DE-540	DE-541	DE-542
Gracey	Gracey	Gracey	Gracey	Gracey	Gracey
1/2 AF	3/4 AF	5/6 AF	7/8 AF	11/12 AF	13/14 AF

Proper care must be given during cleaning, sharpening and sterilization to preserve design and integrity and to prolong usefulness. Do not expose instruments to sterilization temperatures above 350 F/177 C or to higher than recommended chemical concentrations.



- Кюрети
- Curetas
- Küretten
- Кюрети
- Curette
- کرتس

**GRACEY CURETTE
HOLLOW HANDLE 10MM, LENGTH 170MM**

Curetters Set of 8 Pieces



DE-543
Curette
Columbia
2L-2R

DE-544
Curette
Columbia
4L-4R

DE-545
Curette
McCall
13S-14S

DE-546
H6-H7
Scaler
Sickle

DE-547
H5-U15
Scaler
Sickle

DE-548
H5-13
Scaler
Sickle

DE-549
U15-30
Scaler
Sickle

DE-550
U15-33
Scaler
Sickle

FILLING INSTRUMENTS

- Инструменты для реставрации
- Instruments pour plombage
- Füllungsinstrumente (mit Kontrawinkel)
- Инструменти для реставрації
- Instrumentos para obturaciones
- ملء الصكوك

FILLING INSTRUMENTS (Gold Pointed)
SOLID HANDLE 6MM, LENGTH 170MM



Solid Handle Size 4.25"

Tip Size: 1/1"

DE-551 1.5mm / 1.5mm

DE-552 2.0mm / 2.0mm

DE-553 2.0mm / 2.0mm

DE-554 2.5mm / 2.5mm

DE-555 1.3mm / 0.9mm

DE-556 1.6mm / 1.3mm

DE-557 2.4mm / 1.8mm

DE-558 2.4mm / 2.0mm

DE-559 1.3mm / 1.5mm

DE-560 1.8mm / 1.2mm

Filling instrument, spatula 6 mm solid handle, length 170 mm,

Filling instrument 6 mm length 175 mm,

Filling instrument, ball 6 mm length 170 mm,

Filling instrument, ball / spatula 6 mm length 175 mm,

Filling instrument, plan / plan 6 mm length 165 mm,

**EXPLORERS INSTRUMENTS
SOLID HANDLE 6MM, LENGTH 170MM**

- Зонды
 - Sondes
 - Zahnsonden
- Зонди
 - Sondas
 - المستكشفين

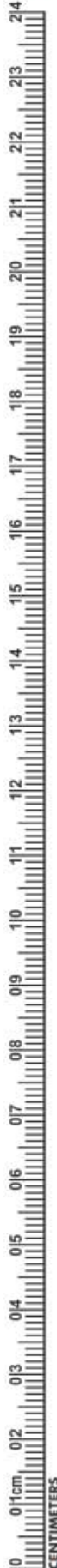

PLUGGERS

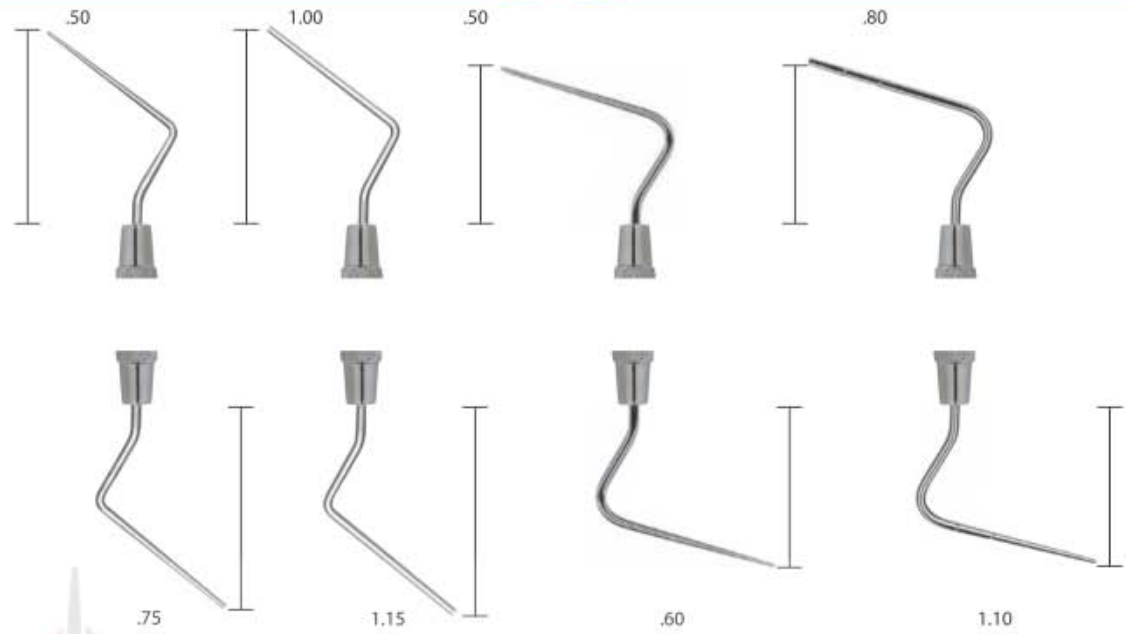

DE-562
5/7
21mm

DE-563
9/11
21mm

DE-564
1/2
Root Canal
Pluggers

DE-565
3/4
Root Canal
Pluggers

DE-561
1/3
21mm

DE-566
MA57
27mm

DE-567
GP3
30mm

DE-568
ISO
Size 30
24mm

DE-569
ISO
Size 40
24mm

DE-570
ISO
Size 50
24mm

DE-571
ISO
Size 60
24mm

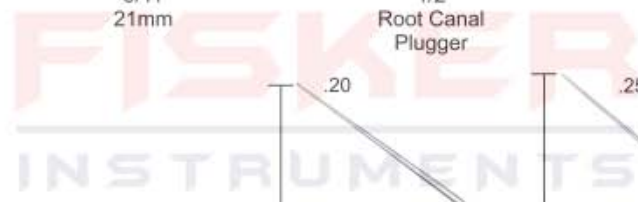

PERIODONTAL PROBES

- Зонды пародонтологические
- Sondes paradontales
- sonde parodontali
- зонди пародонтологічні
- Sondas paradontales
- المسابر اللثة

SPREADERS

HEAT CARRIERS

Tip Size: 1/1

Solid Handle Size 4.25"

Model	ISO / Standard	Size	Tip Size
DE-573	ISO	Size 40	.30
DE-574	ISO	Size 50	.40
DE-575	ISO	Size 60	.60
DE-576	GP1	20mm	.25
DE-577	1S Wakai	22mm	.30
DE-578	2S Wakai	22mm	.40
DE-579	D11 Standard	23mm	.40
DE-580	D11S Thin	23mm	.35
DE-572	ISO	Size 30	.30
DE-581	D11T Thinner	22mm	.23
DE-582	D11TS Thinnest	21mm	.20
DE-583	3	28mm	.35
DE-584	GP2	25mm	.25
DE-585	0‡	25mm	.35
DE-586	00‡	25mm	.55

- Зонды пародонтологические
- Sondes paradontales
- sonda parodontali
- зонди пародонтологічні
- Sondas paradontales
- المسابر اللثة

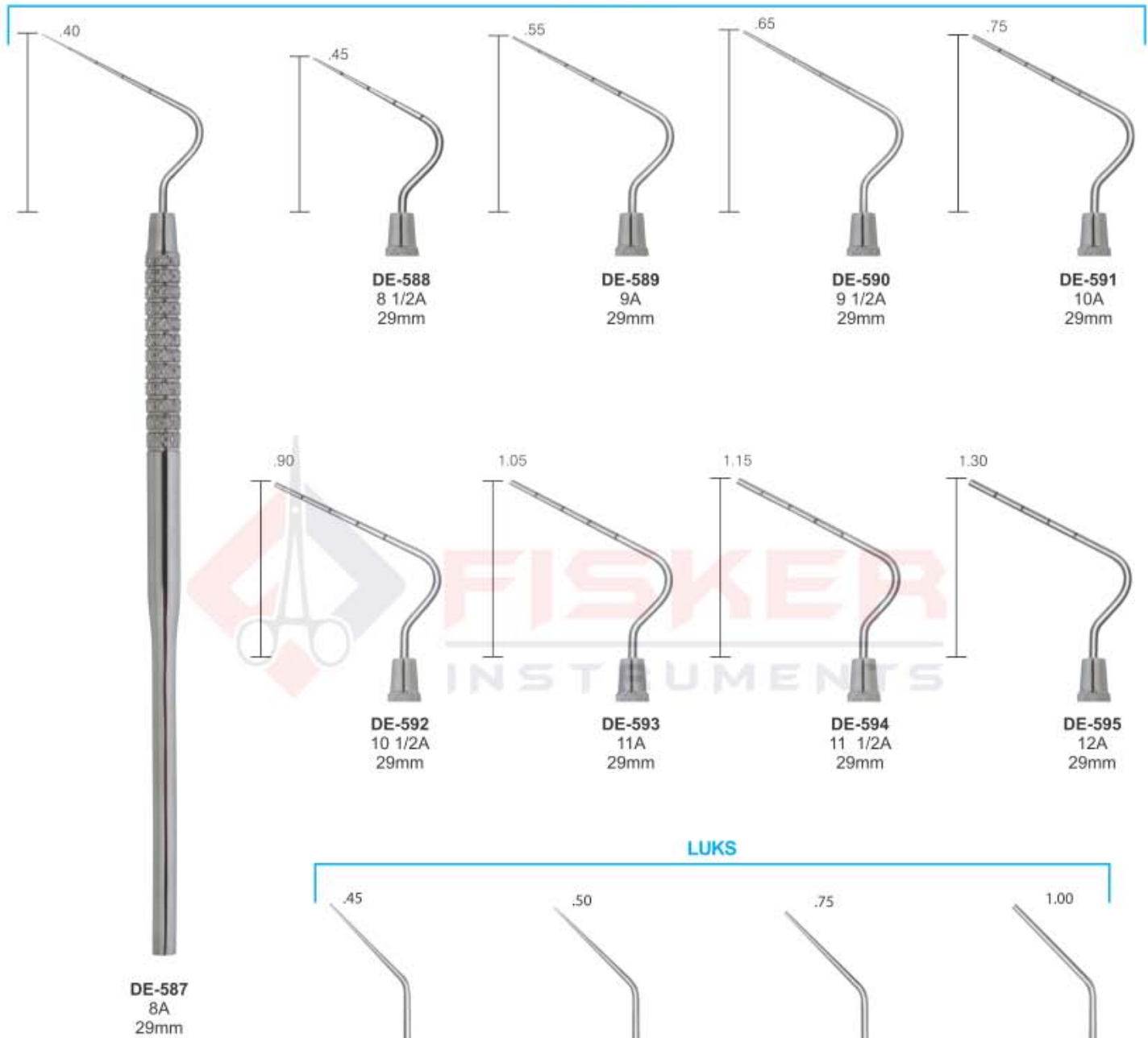
ENDODONTICS INSTRUMENTS
ANTERIOR

LUKS

PERIODONTAL PROBES

- Зонды пародонтологические
- Sondes paradontales
- sonde paradontali
- зонди пародонтологічні
- Sondas paradontales
- المسابير اللثة

ENDODONTICS INSTRUMENTS SOLID HANDLE 6MM, LENGTH 170MM

POSTERIOR

Tip Size: 1/1

Solid Handle Size 5"

DE-600
8
22mm

Tip Size	Model	Length
.40	DE-600	8 / 22mm
.45	DE-601	8 1/2 / 22mm
.55	DE-602	9 / 22mm
.65	DE-603	9 1/2 / 22mm
.75	DE-604	10 / 22mm
.90	DE-605	10 1/2 / 22mm
1.05	DE-606	11 / 22mm
1.15	DE-607	11 1/2 / 22mm
1.30	DE-608	12 / 22mm

RETRO FILLING PLUGGERS

Tip Size: 1/1

Solid Handle Size 4.25"

DE-609
1 Glick
Blade/
Plunger
#41, #6, #7

Tip Size	Model	Length
1.10	DE-609	1 Glick Blade/Plunger #41, #6, #7
.80	DE-610	1
1.10	DE-611	2



- Инструменты для реставрации
- Instruments pour plombage
- Füllungsinstrumente (mit Kontrawinkel)

- Инструменти для реставрації
- Instrumentos para obturaciones
- ملء الصكوك

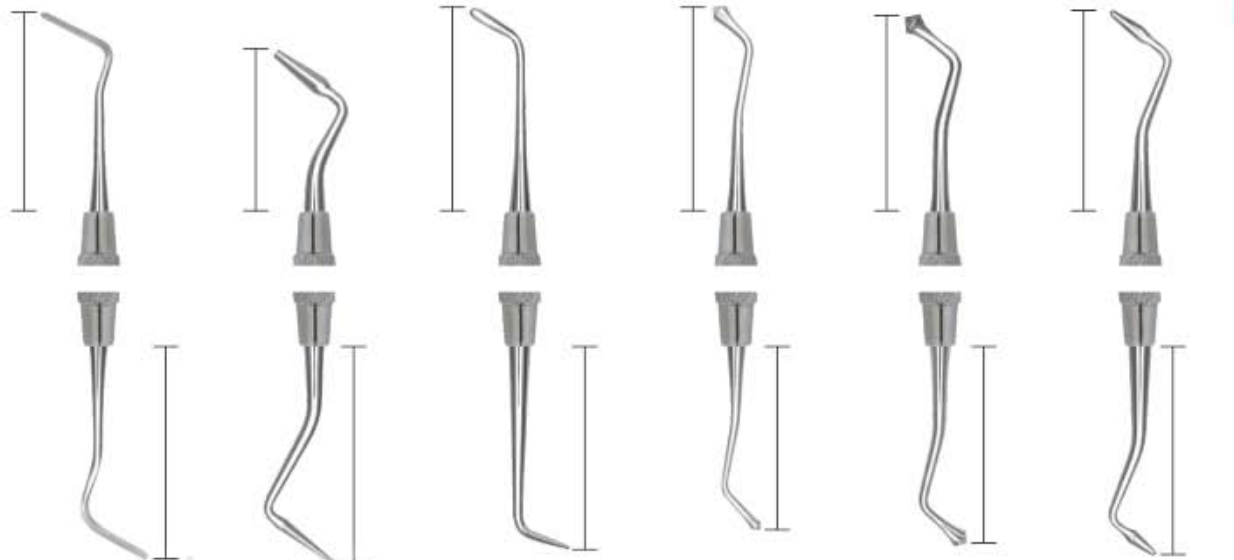
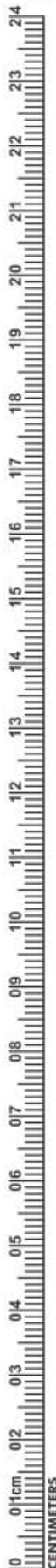
COMPOSITE/PLASTIC FILLING INSTRUMENTS SOLID HANDLE 6MM, LENGTH 170MM
POSTERIOR

DE-613
 Interproximal
 Off-angle

DE-614
 2
 HF

DE-615
 49
 Baldwin

DE-616
 21
 Burnisher
 #41, #6

DE-617
 21B
 Burnisher
 #41, #6

DE-618
 PKT-3R
 Rounded-
 cone
 #41, #6

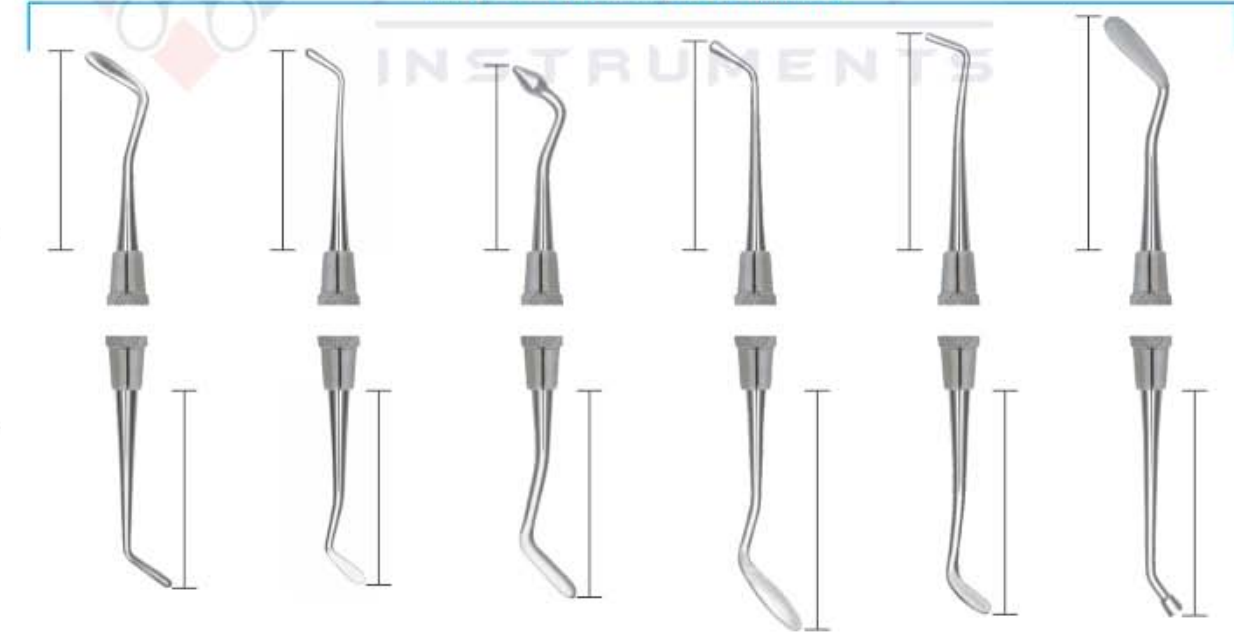
UNIVERSAL FILLING INSTRUMENTS

DE-612
 AB2
 Boghosian

DE-619
 W3
 #41, #6

DE-620
 1

DE-621
 BEQ1
 Quétn
 #41, #7

DE-622
 1
 HF

DE-623
 3T
 Tufts

DE-624
 2
 Woodson
 #41, #6

FILLING INSTRUMENTS

- Инструменты для реставрации
- Instruments pour plombage
- Füllungsinstrumente (mit Kontrawinkel)
- Инструменти для реставрації
- Instrumentos para obturaciones
- ملء الصكوك

COMPOSITE/PLASTIC FILLING INSTRUMENTS SOLID HANDLE 6MM, LENGTH 170MM

BLACK

PLUGGERS/CONDENSERS

Hollenback

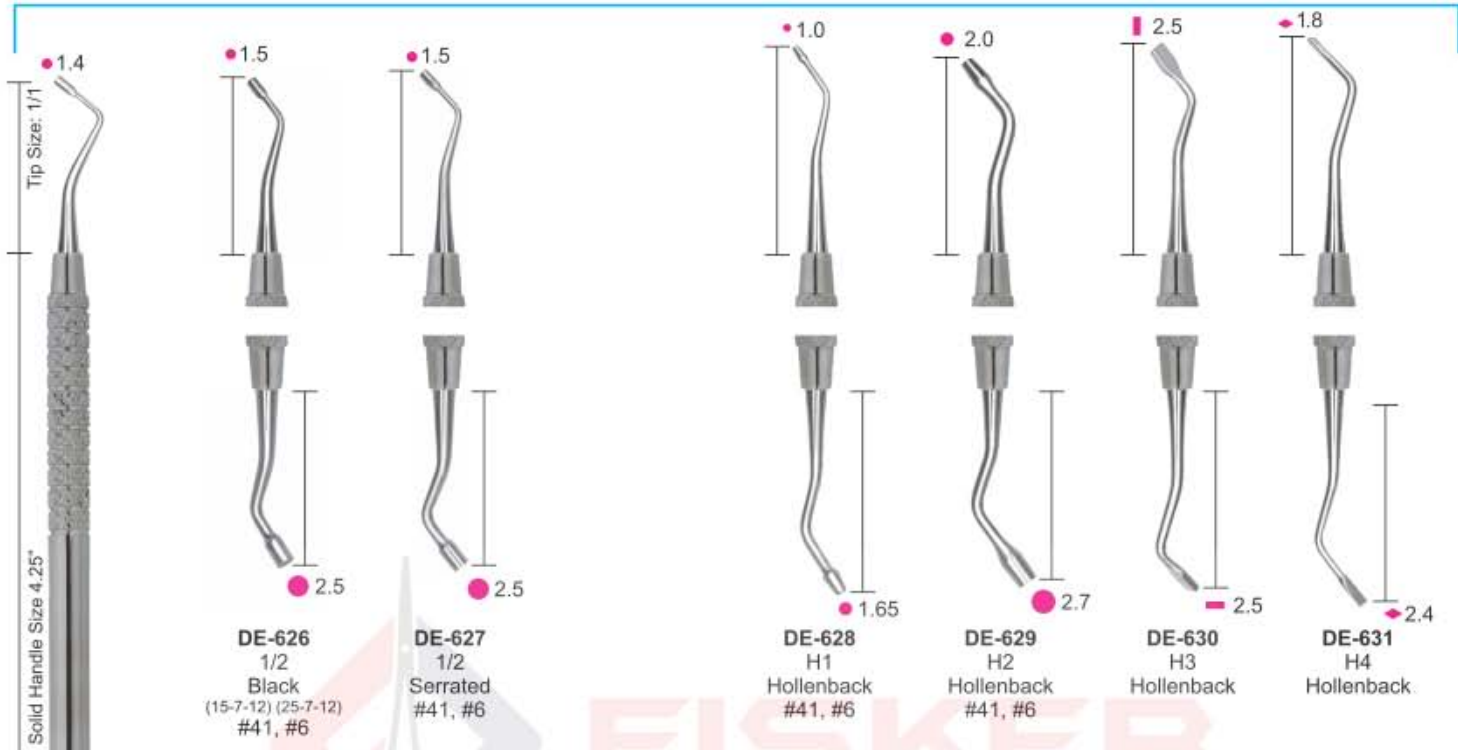

MARQUETTE CONDENSER

MORTONSON

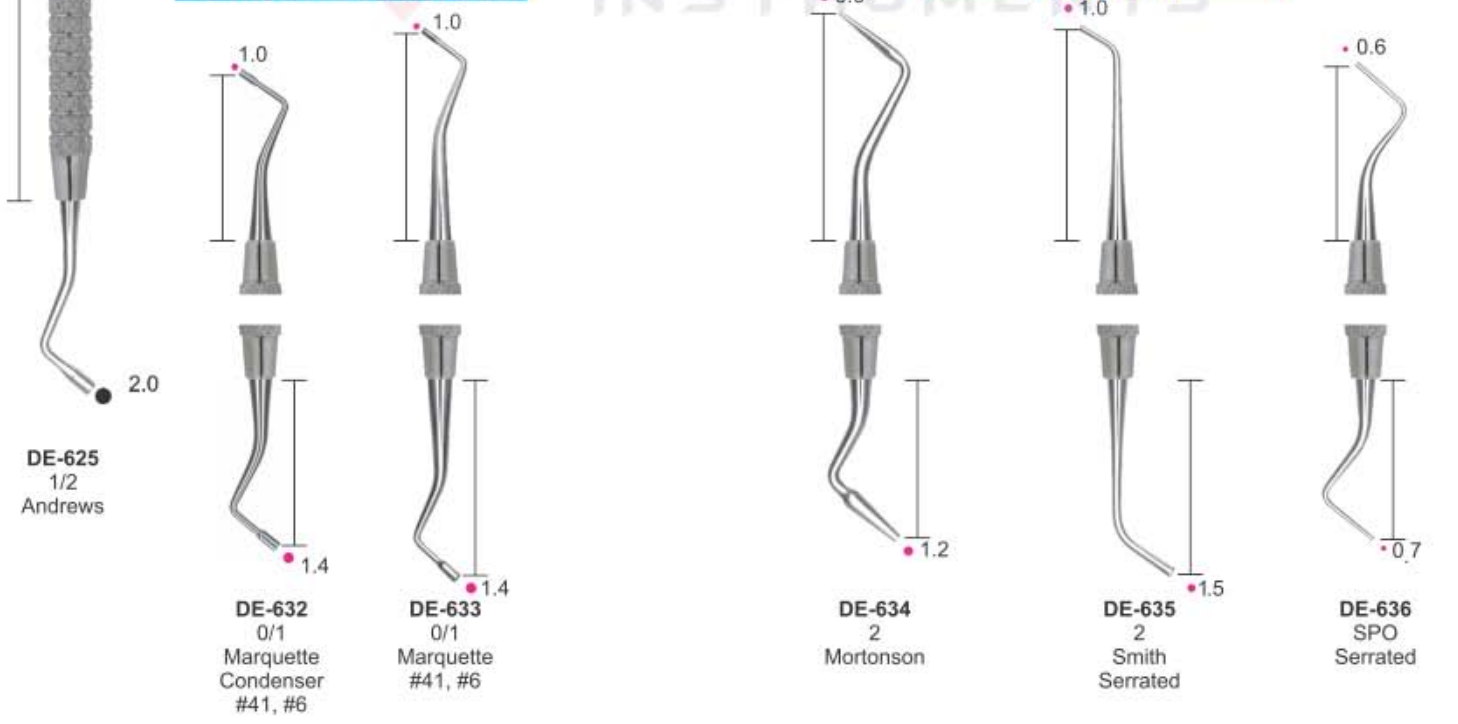

- Инструменты для реставрации
- Instruments pour plombage
- Füllungsinstrumente (mit Kontrawinkel)

- Инструменти для реставрації
- Instrumentos para obturaciones
- ملء الصكوك

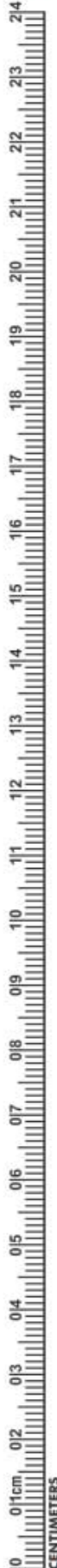
PLUGGERS/CONDENSERS
RESTORATIVE INSTRUMENTS SOLID HANDLE 6MM, LENGTH 170MM

DE-637
 1M
 Markley

DE-638
 2M
 Markley

DE-639
 4M
 Markley

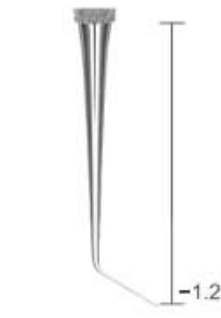
DE-640
 5M
 Markley

DE-641
 6M
 Markley

PLUGGERS/CONDENSERS

DE-642
 1
 Oregon
 #41, #6

DE-643
 2
 Oregon
 #41, #6

DE-644
 3
 Oregon

DE-645
 4
 Oregon
 #41, #6

DE-646
 1
 Ward

DE-647
 2
 Ward

FILLING INSTRUMENTS

- Инструменты для реставрации
- Instruments pour plombage
- Füllungsinstrumente (mit Kontrawinkel)
- Инструменти для реставрації
- Instrumentos para obturaciones
- ملء الصكوك

RESTORATIVE INSTRUMENTS SOLID HANDLE 6MM, LENGTH 170MM

Tanner Filling Instruments

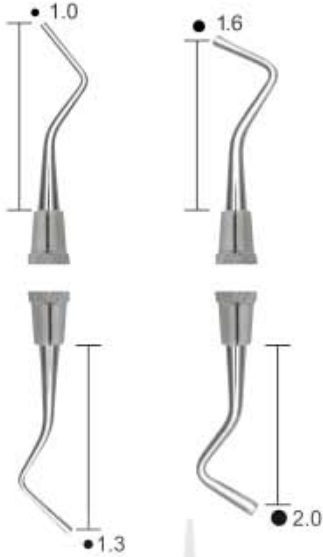
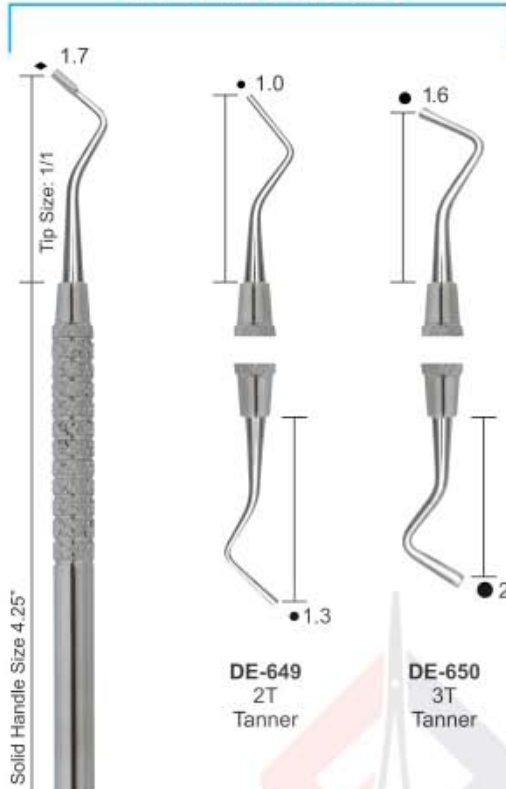

DE-649
2T
Tanner

DE-650
3T
Tanner



DE-651
9/10
Back Action



DE-652
11/12
Back Action



DE-653
153
English Pattern
Serrated



DE-654
153
English Pattern
Serrated

BURNISHERS

BALL

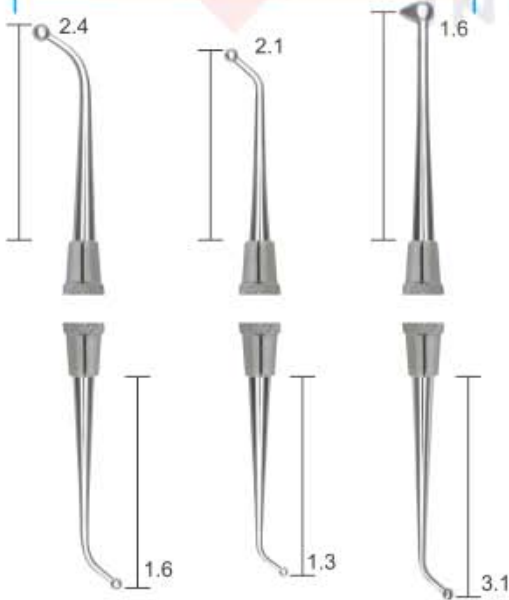

DE-648
1T
Tanner

DE-655
18
#41, #6



DE-656
26/27S
#41, #6



DE-657
27/29
#41, #6, #7, #8



DE-658
2

BEAVERTAIL



DE-659
2
Double-End

ACORN



DE-660
21
#41, #6

DE-661
21B
#41, #6, #8

LADMORE



DE-662
2
Ladmore



- Инструменты для реставрации
- Instruments pour plombage
- Füllungsinstrumente (mit Kontrawinkel)

- Инструменти для реставрації
- Instrumentos para obturaciones
- ملء الصكوك

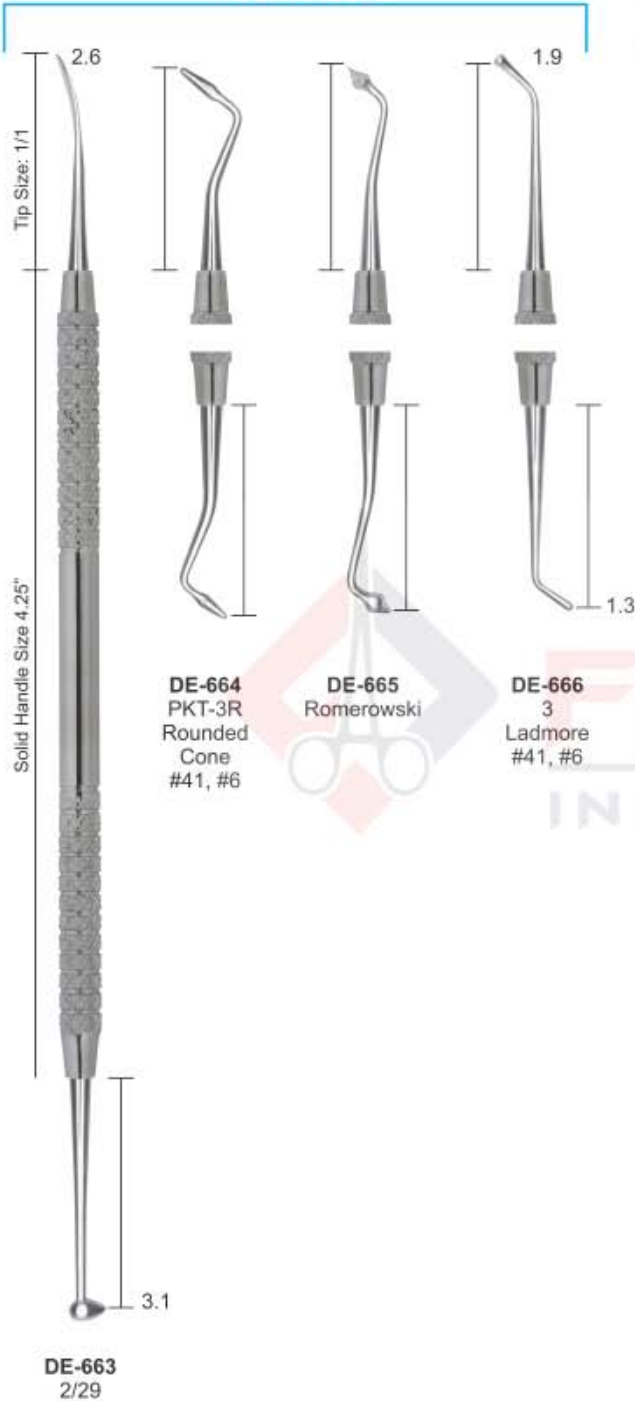
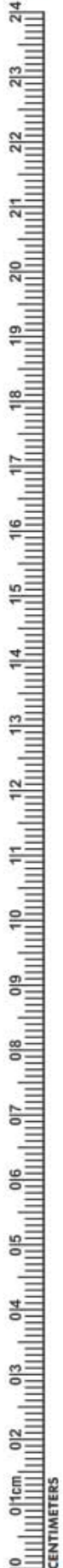
RESTORATIVE INSTRUMENTS SOLID HANDLE 6MM, LENGTH 170MM
BURNISHERS

PERIODONTAL FILES

FILLING INSTRUMENTS

- Инструменты для реставрации
- Instruments pour plombage
- Füllungsinstrumente (mit Kontrawinkel)
- Инструменти для реставрації
- Instrumentos para obturaciones
- ملء الصكوك

COMPOSITE/PLASTIC FILLING INSTRUMENTS SOLID HANDLE 6MM, LENGTH 170MM

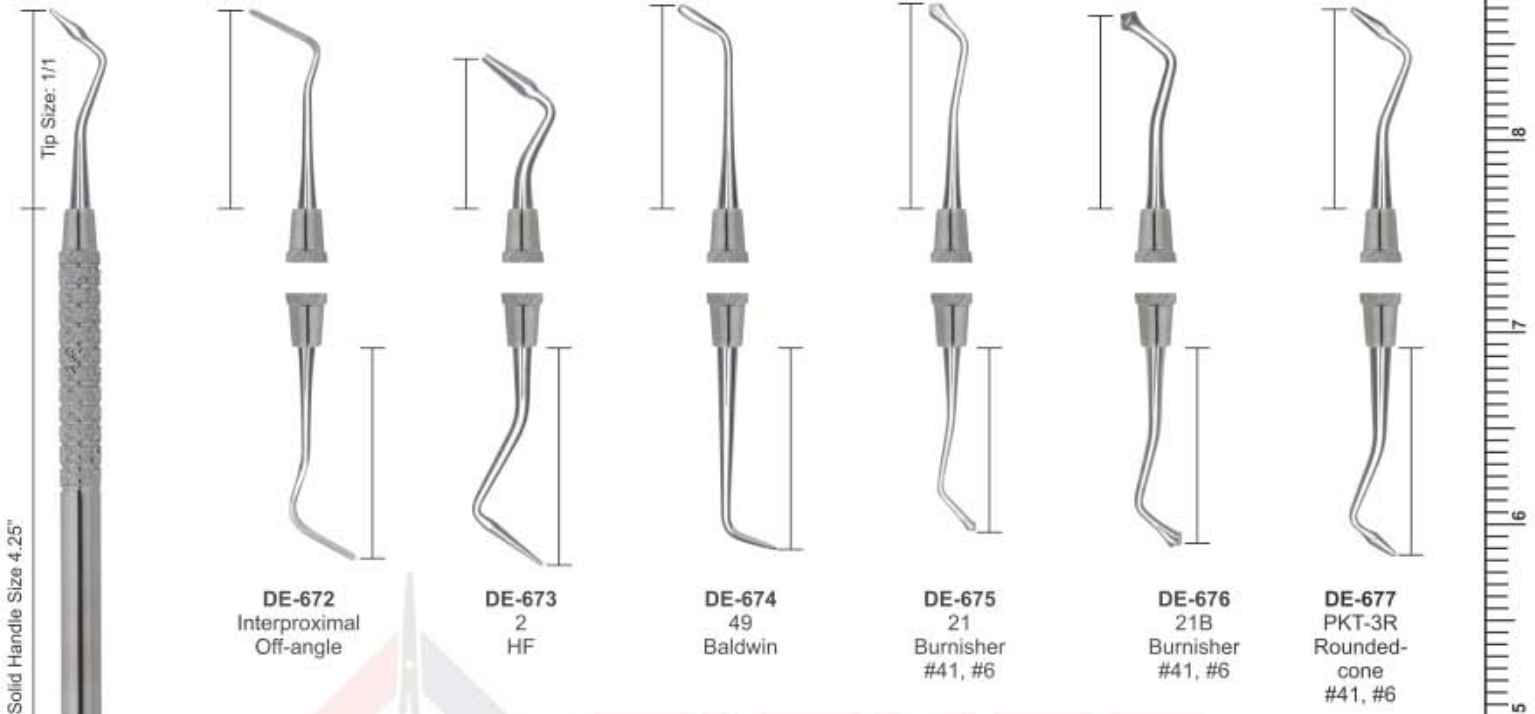
BURNISHER FILLING INSTRUMENTS



DE-672
Interproximal
Off-angle

DE-673
2
HF

DE-674
49
Baldwin

DE-675
21
Burnisher
#41, #6

DE-676
21B
Burnisher
#41, #6

DE-677
PKT-3R
Rounded-
cone
#41, #6

UNIVERSAL FILLING INSTRUMENTS



DE-671
AB2
Boghosian

DE-678
W3
#41, #6

DE-679
1

DE-680
BEQ1
Quétin
#41, #7

DE-681
1
HF

DE-682
3T
Tufts

DE-683
2
Woodson
#41, #6

- Инструменты для реставрации
- Instruments pour plombage
- Füllungsinstrumente (mit Kontrawinkel)

- Инструменти для реставрації
- Instrumentos para obturaciones
- ملء الصكوك

FILLING INSTRUMENTS
SOLID HANDLE 6MM, LENGTH 170MM

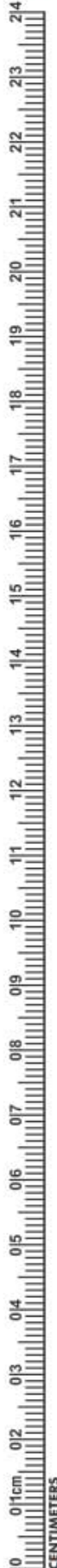

AMALGAM CARVERS

- Инструменты для реставрации
- Instruments pour amalgame
- Amalgampistolen
- Инструменти для реставрації
- instrumentos para amalgama
- تطعيع الملقم

AMALGAM INSTRUMENTS SOLID HANDLE 6MM, LENGTH 170MM



- Инструменты для реставрации
- Instruments pour amalgame
- Amalgampistolen
- Инструменти для реставрації
- instrumentos para amalgama
- تطبيع الملعق

AMALGAM INSTRUMENTS SOLID HANDLE 6MM, LENGTH 170MM

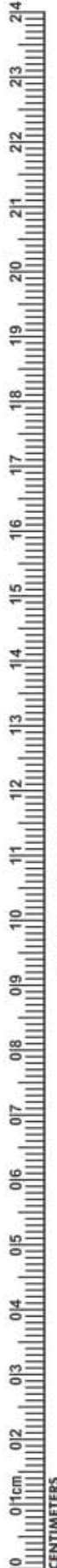

- Инструменты пародонтологические
- Instruments pour la parodontologie
- Instrumente für die Parodontologie
- Инструменти пародонтологічні
- instrumentos para periodoncia
- الصكوك اللثة

SICKLE SCALERS INSTRUMENTS SOLID HANDLE 6MM, LENGTH 170MM

SICKLE SCALERS



- Инструменты пародонтологические
- Instruments pour la parodontologie
- Instrumente für die Parodontologie

- Інструменти пародонтологічні
- instrumentos para periodoncia
- الصكوك اللثة

PERIODONTAL INSTRUMENTS SOLID HANDLE 6MM, LENGTH 170MM
JACQUETTE SCALERS
CRANE-KAPLAN

DE-731
 30/33
 Hygienist
 Jacquette
 #2, #4, #6,
 #7, #8, #9

DE-732
 31/32
 Jacquette
 #2, #4, #6,
 #7, #8, #9

DE-733
 34/35
 Jacquette
 #2, #4, #6,
 #7, #8, #9

DE-734
 H3/H4
 Jacquette
 #2, #4, #6,
 #7, #8, #9

DE-735
 14/15
 Posterior
 Jacquette
 #2, #4, #6,

DE-736
 CK-6
 #2, #4, #6,

PERIODONTAL INSTRUMENTS

- Инструменты пародонтологические
- Instruments pour la parodontologie
- Instrumente für die Parodontologie
- Инструменти пародонтологічні
- Instrumentos para periodoncia
- الصكوك اللثة

PERIODONTAL INSTRUMENTS SOLID HANDLE 6MM, LENGTH 170MM SCALER/CURETTE SETS



Tip Size: 1/1

Solid Handle Size 4.25"

DE-737
11/12
Scaler
#2, #6,
#7, #8

DE-738
11A/12A
Scaler
#2, #4, #6,

DE-739
11/12S
Modied
McCall
#4, #6

DE-740
13S/14S
Pointed
Curette
#2, #4, #6
#7, #8, #9

DE-741
MTC 13/14
Pointed
Curette
#4, #6

DE-742
17S/18S
Curette
#2, #4, #6
#7, #8, #9

DE-743
19/20
Curette
#2

INCHES

- Кюрети
- Curetas
- Küretten
- Кюрети
- Curette
- کرش

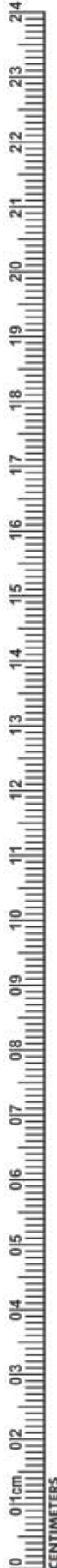
SCALER/CURETTE SETS
GOLDMAN-FOX SET

- | | | | | | | | | | |
|------------------------------------|---|--|---|---|--|--|--|---|---|
| DE-744
103/106
#4, #6 | DE-744A
104/105
Hoe/Chisel
#4, #6 | DE-745
107/108
#2, #4, #6
#7, #8 | DE-746
107/108S
Modied
#2, #4 | DE-747
1/2
(shown)
#2, #4, #6
#7, #8, #9 | DE-749
3/4†
(shown)
#2, #4, #6
#7, #8, #9 | DE-751
5/6†
(shown)
#2, #4, #6
#7, #8, #9 | DE-754
7/8†
(shown)
#2, #4, #6
#7, #8, #9 | | |
| | | | | DE-748
1/2
Rigid
#2, #4, #6
#7, #8, #9 | DE-750
3/4
Rigid
#2, #4, #6
#7, #8, #9 | DE-752
5/6
Rigid
#2, #4, #6
#7, #8, #9 | DE-753
5/6
Extra Rigid
#4, #6 #7,
#8 | DE-755
7/8
Rigid
#2, #4, #6
#7, #8, #9 | DE-756
7/8
Extra Rigid
#2, #4, #6
#7, #8, #9 |

**SCALER/CURETTE SETS INSTRUMENTS
SOLID HANDLE 6MM, LENGTH 170MM**

CURETTES

- Кюрети
- Curetas
- Kuretten
- Кюрети
- Curette
- كرتس

GRACEY CURETTE INSTRUMENTS SOLID HANDLE 6MM, LENGTH 170MM GRACEY CURETTES



DE-757
9/10†
(shown)
#2, #4, #6
#7, #8, #9

DE-759
11/12†
(shown)
#2, #4, #6
#7, #8, #9

DE-792
13/14†
(shown)
#2, #4, #6
#7, #8, #9

DE-765
15/16†
(shown)
#2, #4, #6
#7, #8, #9

DE-767
17/18
#2, #4, #6
#7, #8, #9

DE-758
9/10
Rigid
#2, #4, #6
#7, #8

DE-760 11/12 Rigid #2, #4, #6 #7, #8, #9	DE-761 11/12 Extra Rigid #4, #6 #7, #8
---	---

DE-793 13/14 Rigid #2, #4, #6 #7, #8, #9	DE-764 13/14 Extra Rigid #4, #6 #7, #8
---	---

DE-766
15/16
Rigid
#2, #4, #6
#7, #8, #9

DE-768
17/18
Rigid
#2, #4, #6
#7, #8, #9



- Кюрети
- Curetas
- Küretten
- Кюрети
- Curette
- کرتس



**CURETTE INSTRUMENTS
HOLLOW HANDLE 8.5MM, LENGTH 170MM**

**CURETTE INSTRUMENTS
SOLID HANDLE 6MM, LENGTH 170MM**

**CURETTE INSTRUMENTS
SOLID HANDLE 6MM, LENGTH 170MM**



DE-769
Hemingway
2mm, 2mm

DE-770
Hemingway
3mm, 3mm

DE-771
Hemingway
4mm, 4mm

DE-772
Hemingway
2mm, 2mm

DE-773
Hemingway
3mm, 3mm

DE-774
Hemingway
4mm, 4mm

DE-775
Hemingway
2mm, 2mm

DE-776
Hemingway
3mm, 3mm

DE-777
Hemingway
4mm, 4mm

EXCAVATORS

- Экскаваторы
- Excavateurs
- Excavatoren
- عسكافوتوري
- Excavadores
- حفارات

EXCAVATORS INSTRUMENTS SOLID HANDLE 6MM, LENGTH 170MM SPOONS



- Экскаваторы
- Excavateurs
- Excavatoren
- Excavatori
- Excavadores
- حفارات

EXCAVATORS INSTRUMENTS
SOLID HANDLE 6MM, LENGTH 170MM

BLADES



Model	Tip Size	Blade Length (inches)	Handle Length (inches)
DE-796 36/37 (15-8-14) #41, #6	1/1	1.5	4.25
DE-797 40/41 (11-7-14)	1/1	1.1	4.25
DE-798 44/45 (20-9-14) #41, #6	1/1	2.0	4.25
DE-799 61/62 (20-9-12)	1/1	2.0	4.25
DE-800 63/64 (15-8-12)	1/1	1.5	4.25
DE-801 65/66 (10-6-12)	1/1	1.0	4.25

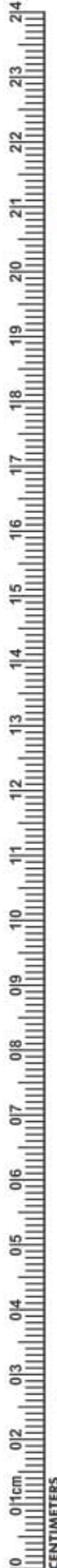

- Экскаваторы
- Excavateurs
- Excavatoren
- Екскаватори
- Excavadores
- حفارات

EXCAVATORS INSTRUMENTS SOLID HANDLE 6MM, LENGTH 170MM
ENGLISH PATTERNS

DE-802 Goldstein Interproximal Excavator	DE-803 243	DE-804 244	DE-805 245	DE-806 246	DE-807 125/126 #41, #6	DE-808 127/128 #41, #6	DE-809 129/130 #41, #6	DE-810 131/132 #41, #6	DE-811 153/154
---	---------------	---------------	---------------	---------------	------------------------------	------------------------------	------------------------------	------------------------------	-------------------

FILLING INSTRUMENTS

- Инструменты для реставрации
- Instruments pour plombage
- Füllungsinstrumente (mit Kontrawinkel)
- Инструменти для реставрації
- Instrumentos para obturaciones
- ملء الصكوك

HATCHETS

RESTORATIVE INSTRUMENTS SOLID HANDLE 6MM, LENGTH 170MM

Tip Size: 1/1

Solid Handle Size 4.25"

DE-812
8/9H
(10-7-14)
#41, #6

DE-813
13/14
(20-9-14)

DE-814
15/16
(15-8-14)

DE-815
17/18
(10-6-14)
#41, #6

DE-816
51/52
(15-8-12)

DE-817
53/54
(10-6-12)
#41, #6

DE-818
8A
#41, #6

DE-819
11
#41, #6

DE-820
179

DE-821
G

DE-822
1/2
Trico

DE-823
DPT6
Darby Perry
Trimmer

DE-824
W1

DE-825
1
Woodson
#41, #6

INCHES

0 1 2 3 4 5 6 7 8 9

- Инструменты для реставрации
- Instruments pour plombage
- Füllungsinstrumente (mit Kontrawinkel)

- Инструменти для реставрації
- Instrumentos para obturaciones
- ملء الصكوك

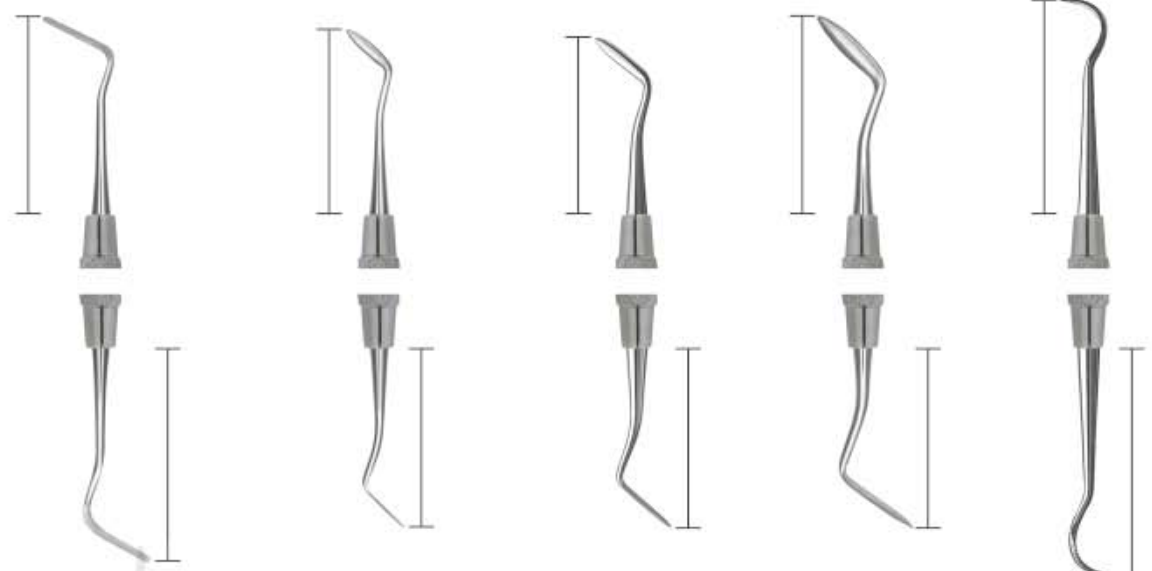
CARVERS
RESTORATIVE INSTRUMENTS SOLID HANDLE 6MM, LENGTH 170MM

DE-827
 Inter-proximal
 Off-Angle

DE-828
 1/2-3
 Hollenback
 #41, #6,
 #7, #8

DE-829
 3S
 Hollenback
 #41, #6, #7

DE-830
 3
 Hollenback

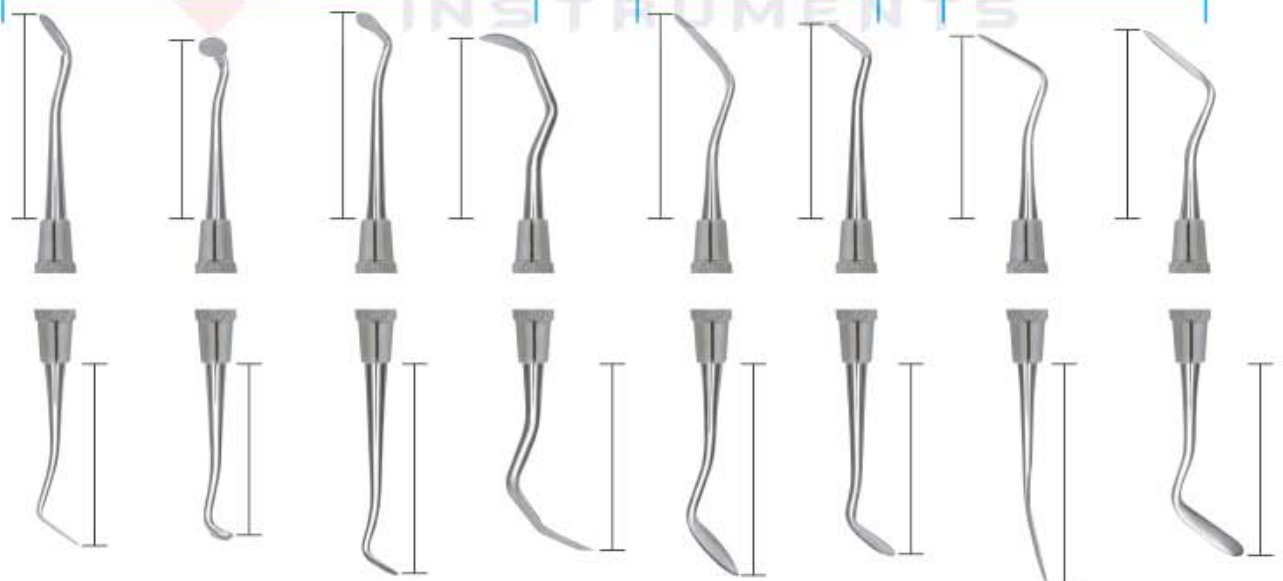
DE-831
 8
 Wiland
 Minn.IPC1
 #41, #6, #7

TANNER
WALL
WARD

DE-826
 Inter-proximal
 #41, #6, #7

DE-832
 3
 Tanner

DE-833
 4
 Tanner

DE-834
 5
 Tanner

DE-835
 6
 Tanner

DE-836
 1
 Wall

DE-837
 3
 Wall

DE-838
 1
 Ward

DE-839
 2
 Ward

AMALGAM CARVERS

- Инструменты для реставрации
- Instruments pour amalgame
- Amalgampistolen
- Инструменти для реставрації
- instrumentos para amalgama
- تطعيع الملقم

RESTORATIVE INSTRUMENTS

ANDREW SOLID HANDLE 6MM, LENGTH 170MM CLAPPISON/FRAHAM

HOLLENBACK

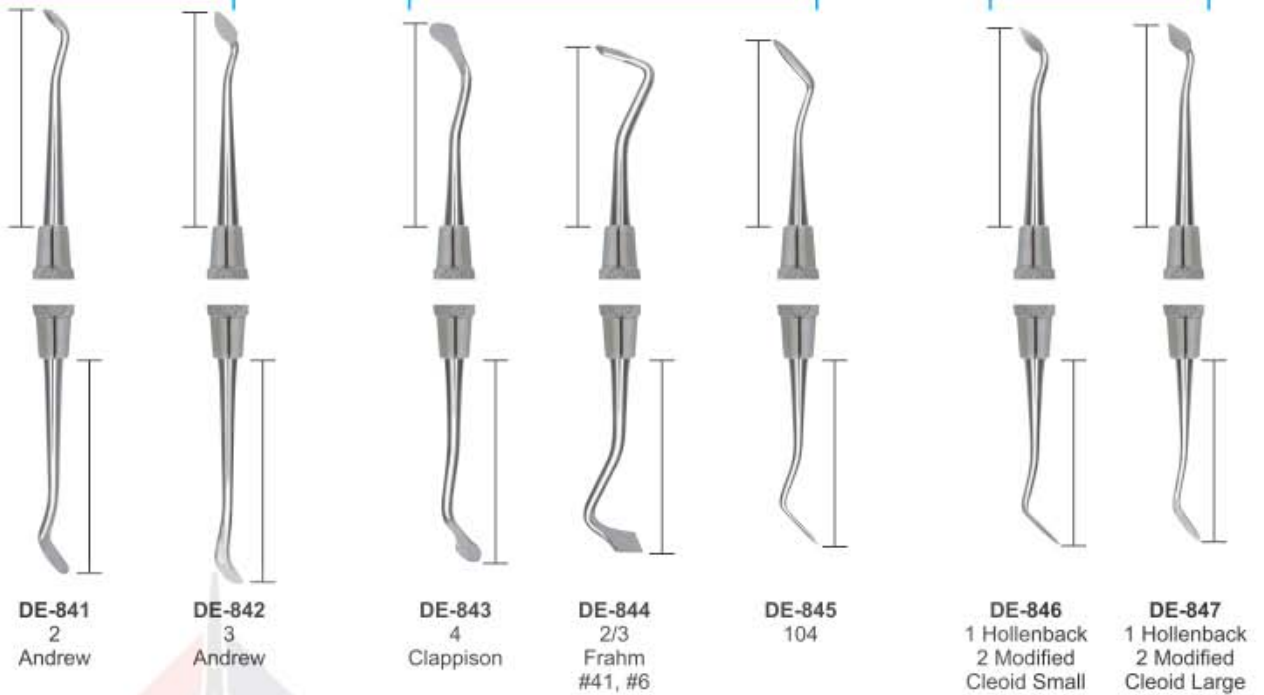

HOLLENBACK

THARP

DE-840
1
Andrew

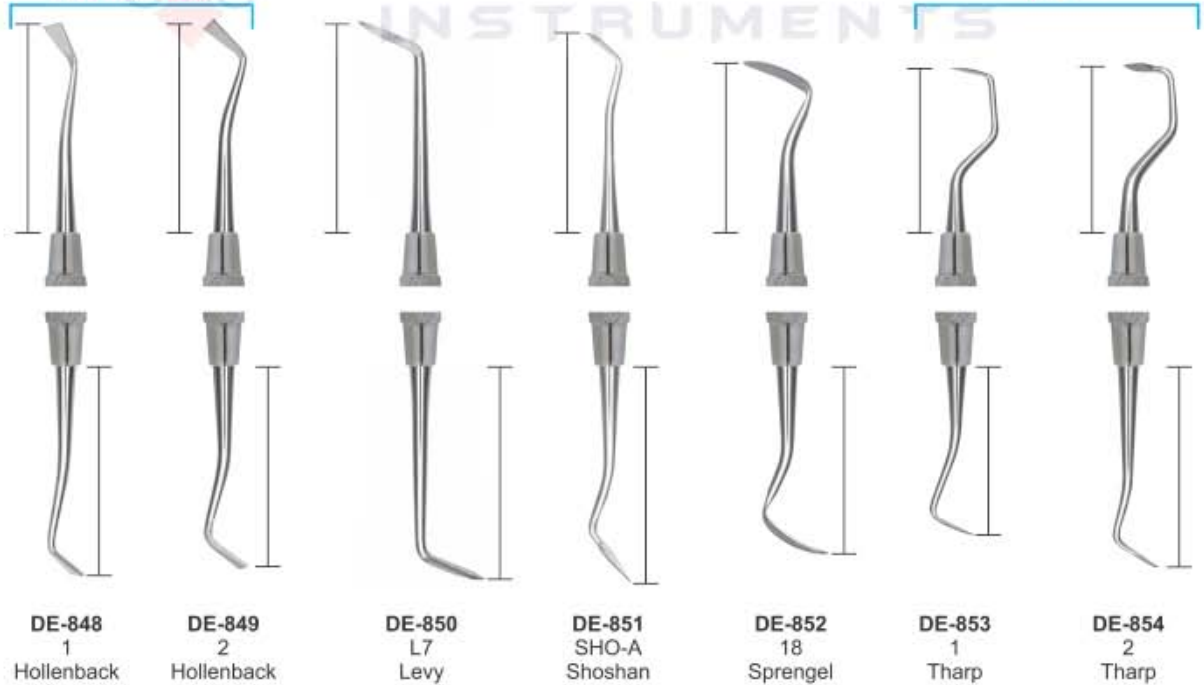

- Инструменты для реставрации
- Instruments pour amalgame
- Amalgampistolen
- Инструменти для реставрації
- instrumentos para amalgama
- تقطيع الملغم

RESTORATIVE INSTRUMENTS SOLID HANDLE 6MM, LENGTH 170MM

CARVERS

AMALGAM FILES

HOES

Forming Line Angles on Anterior Preparations.



DISCOID-CLEOIDS

DISCOID-CLEOIDS

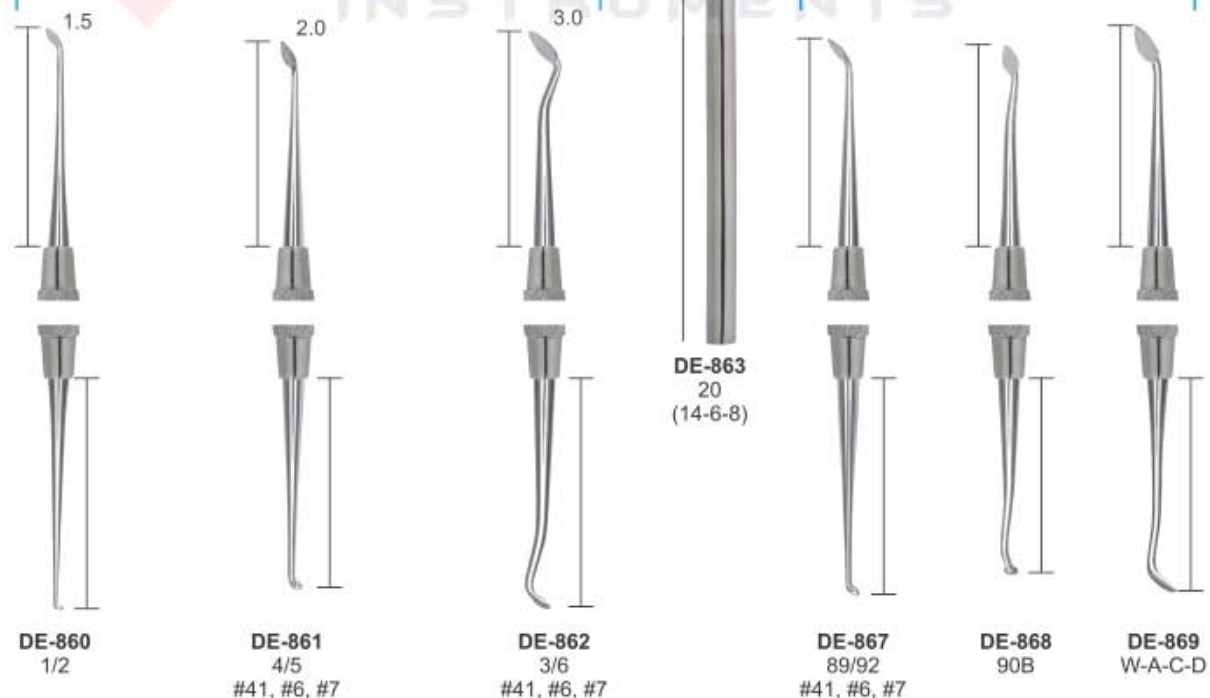

FILLING INSTRUMENTS

- Инструменты для реставрации
- Instruments pour plombage
- Füllungsinstrumente (mit Kontrawinkel)
- Инструменти для реставрації
- Instrumentos para obturaciones
- ملء الصكوك

RESTORATIVE INSTRUMENTS
SOLID HANDLE 6MM, LENGTH 170MM

MARGIN TRIMMERS

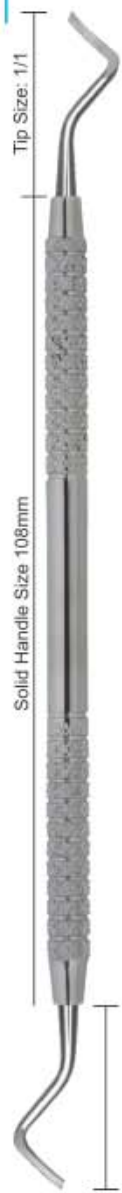

DE-870
26
(13-95-8-14)
Distal



DE-871
27
(13-80-8-14)
Mesial



DE-872
28
(10-95-7-14)
Distal
#41, #6



DE-873
29
(10-80-7-14)
Mesial
#41, #6



DE-874
77/78
(15-95-8-12)
Distal



DE-875
79/80
(15-80-8-12)
Mesial



FISHER
INSTRUMENTS

ANGLE FORMERS



DE-876
30/31
(12-80-5-8)



DE-877
32/33
(9-80-4-8)



DE-878
34/35
(7-80-2.5-9)



- Инструменты для реставрации
- Instruments a modeler
- Modellierinstrumente

- Инструменти для реставрації
- Instrumentos para modelar
- أدوات تقطيع

P.K. THOMS WAXING INSTRUMENTS SOLID HANDLE 6MM, LENGTH 170MM

P.K. THOMAS WAXING INSTRUMENTS

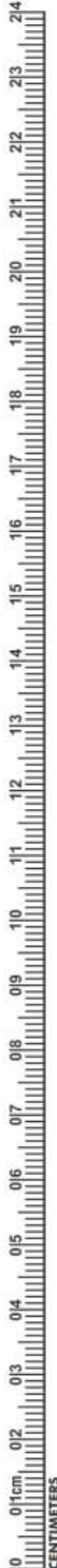

DE-879
PKT-1

DE-880
PKT-2

DE-881
PKT-3
#41, #6

DE-882
PKT-3R
Rounded
Cone

DE-883
PKT-4

DE-884
PKT-5

DE1-884
P.k. Thomas Waxing
Instruments
Kit



COMPOSITE FILLING INSTRUMENTS

- Инструменты для реставрации
- Instruments pour plombage
- Füllungsinstrumente (mit Kontrawinkel)
- Инструменти для реставрації
- Instrumentos para obturaciones
- ملء الصكوك

Composite Gold Tip Instruments

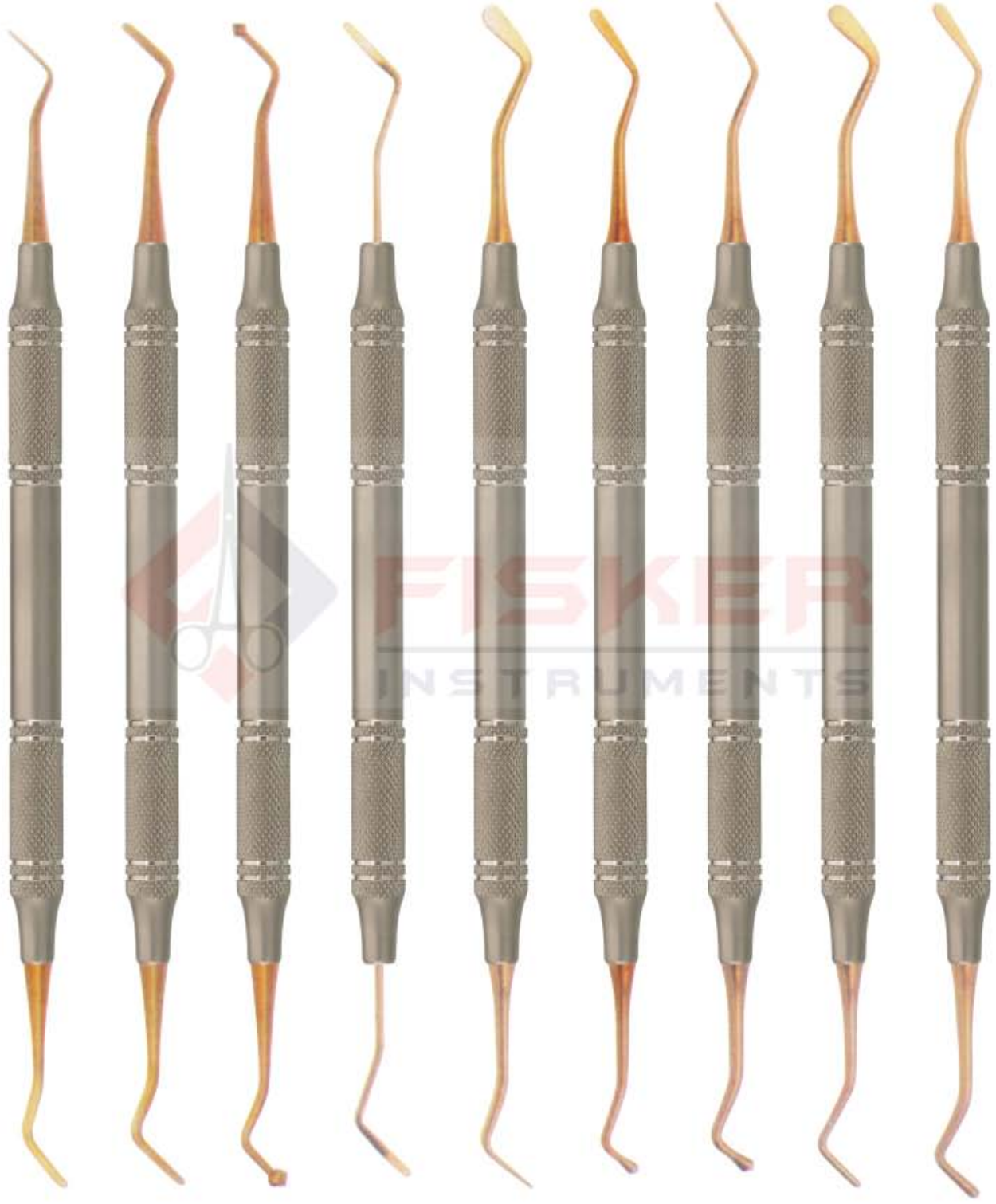

DE1-892 DE2-892 DE3-892 DE4-892 DE5-892 DE6-892 DE7-892 DE8-892 DE9-892



- Инструменты для реставрации
- Instruments pour plombage
- Füllungsinstrumente (mit Kontrawinkel)

- Инструменти для реставрації
- Instrumentos para obturaciones
- ملء الصكوك

Composite Gold Tip Instruments



DE10-892
Markley 2



DE11-892
Westcott N.21



DE12-892
NYU/B2



DE13-892
Filling instruments



DE14-892
Ball Filling Instruments

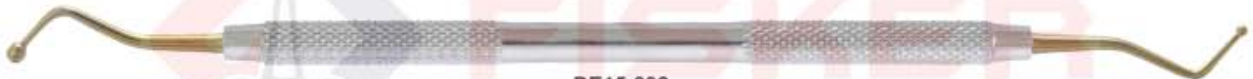

DE15-892
Filling Instruments



DE16-892
Filling Instruments



DE17-892
Filling Instruments



DE18-892
Plastic Filling Instruments



DE19-892
Heidemann



DE20-892
Plastic Filling Instruments



FILLING INSTRUMENTS

- Инструменты для реставрации
- Instruments pour plombage
- Füllungsinstrumente (mit Kontrawinkel)
- Инструменти для реставрації
- Instrumentos para obturaciones
- ملء الصكوك

COMPOSITE INSTRUMENTS TITANIUM BLUE ENDODONTIC

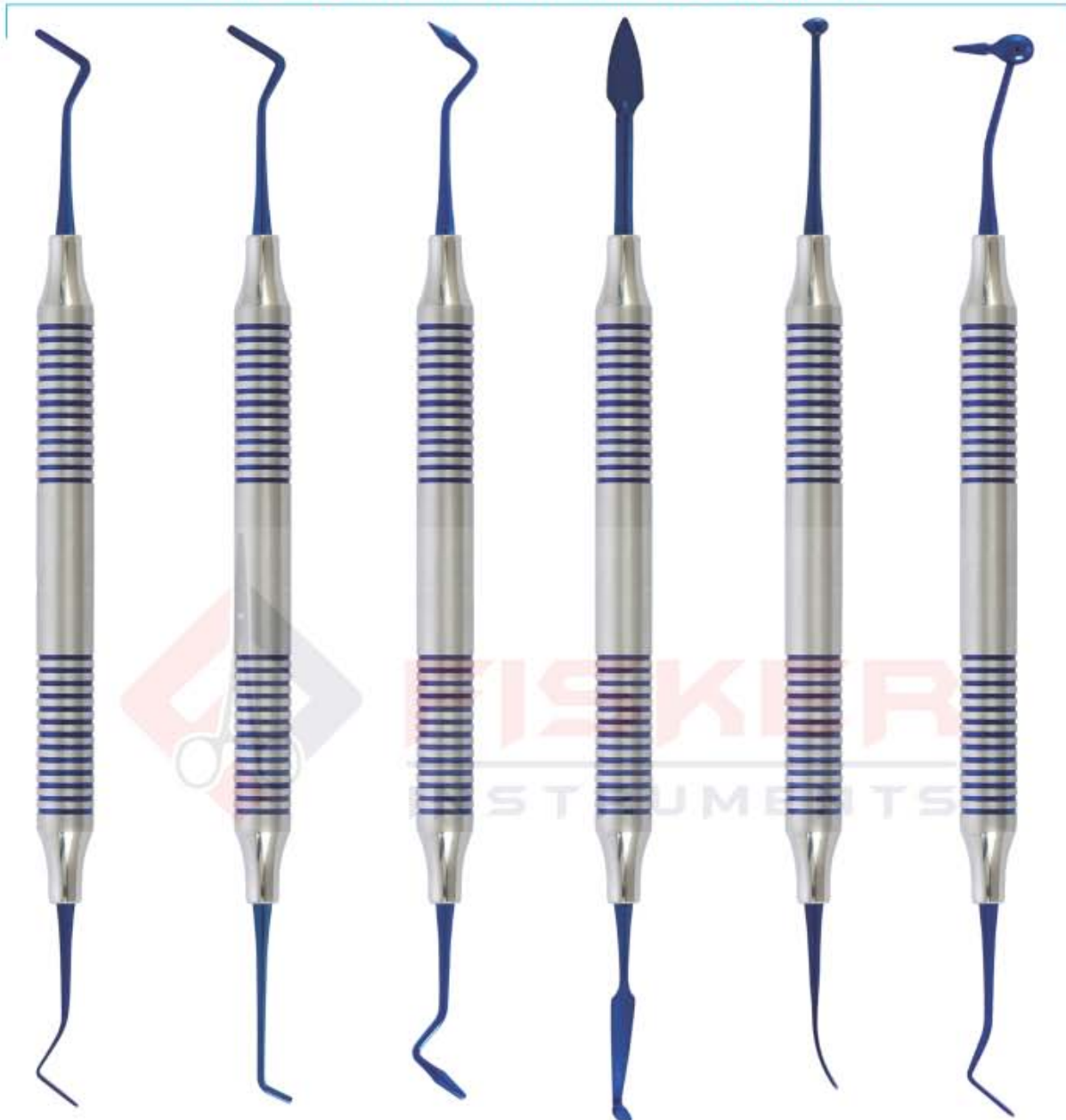

DE21-892

DE22-892

DE23-892

DE24-892

DE25-892

DE26-892



DE27-892
Composite Instruments Blue
Titanium with Cassettes



- Прочие товары
- Divers produits et services
- Sonstige Produkte
- Інші товари
- Varios Productos
- المنتجات المتنوعة

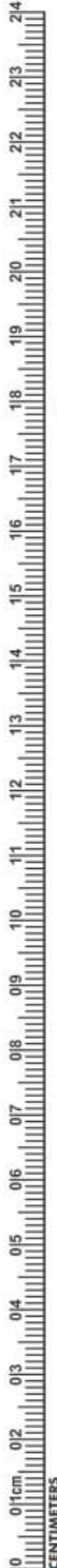

DE28-892
X Ray Film Hangers



DE29-892
X Ray Film Hangers



DE30-892
X Ray Film Hangers



DE31-892
X Ray Film Hangers



DE32-892
X Ray Film Hangers



DE33-892
X Ray Film Hangers



DE34-892
X Ray Film Hangers



DE35-892



DE36-892



DE37-892



Dissecting Set
DE38-892 Set of 9 Pcs.
DE39-892 Set of 11 Pcs.



DE40-892
Napkin Holder with
Plastic Chain



DE41-892
Napkin holder with metal chain



Mouth Props
DE42-892
Small

Mouth Props
DE43-892
Medium

Mouth Props
DE44-892
Large

Key Rings



DE45-892



DE46-892



DE47-892



DE48-892



DE49-892



DE50-892

FILLING INSTRUMENTS

- Инструменты для реставрации
- Instruments pour plombage
- Füllungsinstrumente (mit Kontrawinkel)
- Инструменти для реставрації
- Instrumentos para obturaciones
- ملء الصكوك

CHISELS

HOES



- Шпатели для цемента
- Spatules à ciment
- Zementspatel

- Шпатели для цементу
- Espátulas para cemento
- ملاعق الاسمنت

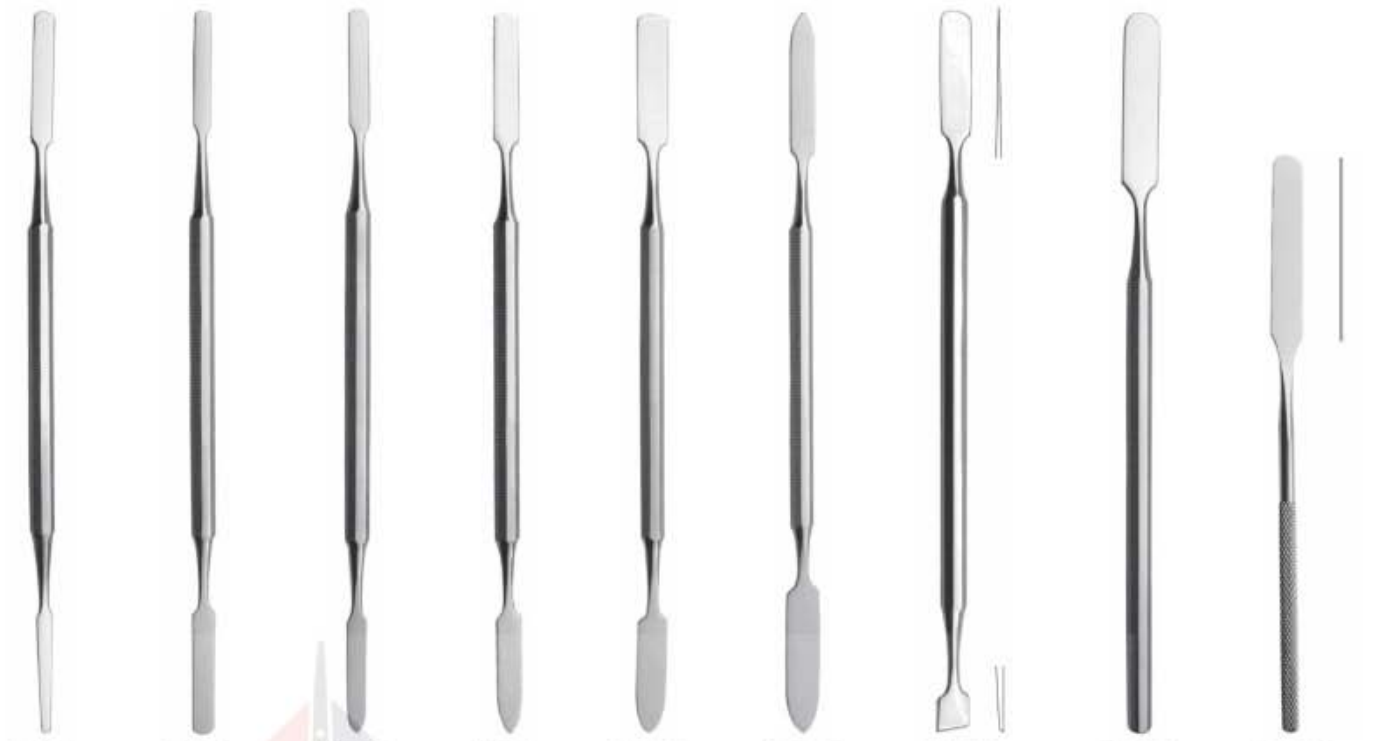
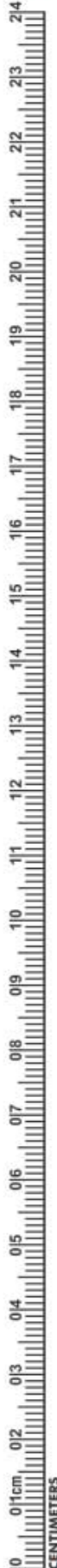

DE-893 00 DE-894 0 DE-895 1 DE-896 2 DE-897 3 DE-898 4 DE-899 3
 Weston DE-900 1 medium cement DE-901 1



DE-902 Le Cron DE-903 Le Cron DE-904 Le Cron DE-905 MSY DE-906 MSY DE-907 Le Cron DE-908 Hylin DE-909 Hylin DE-910 Hylin DE-911 Zahle DE-912 Zahle DE-913 Zahle DE-914 Gritman

WAX KNIVES

- Ножи для воска
- Couteaux a cire
- Wachsmesser
- Ножи для воску
- Cuchillos para cera
- السكاكين الشمع

ALGINATE, PLASTER SPATULAS, WAX KNIVES PLASTER FOR KNIVES & PLASTER SHEAR



DE-915
Wooden Handle
Fig. 5
21.5 cm



DE-916
Wooden Handle
Fig. 7
19.5 cm curved



DE-917
Wooden Handle
Fig. 8
20 cm curved



DE-918
Wooden Handle
Fig. 9
22.5 cm curved



DE-919
Hook Knives



DE-920
Fig. 1
Lessmann
12.5 cm



DE-921
Fig. 2
Lessmann
17 cm



DE-922
Fig. 1
with small spoon
12.5 cm



DE-923
Fig. 2
with large spoon
17 cm



DE-924
Bacolite Handle
Wax Knives,
Small



DE-925
Bacolite Handle
Wax Knives,
Large



DE-926
Wooden Handle
Wax Knives,
Small



DE-927
Wooden Handle
Wax Knives,
Large



DE-928
Plaster Knife



DE-929
Fig. 1
17 cm



DE-930
Fig. 3
16 cm



DE-931
Fig. 4
16 cm



DE-932
Special Inox
19.5 cm



- Артикуляторы
- Artocilar
- Artikulations

- Артикулятори
- Articuler
- آرتيكولاتورس

DE-933
Technical Datas:

Intercondylar distance	120 mm.
condylar inclination	fixed at 30°
Bennet angle	fixed at 7°
Incisal table inclination	10°
Distance between mounting plates	85 mm.
Weight	400 gr.
Opening (item 5000)	125°
Opening (item 5010)	180°

DE-934
Technical Datas:

Intercondylar distance	110 mm.
condylar inclination	fixed at 30°
Bennet angle	fixed at 7°
Incisal table inclination	flat
Distance between mounting plates	85 mm.
Weight	450 gr.
Opening	180°

DE-935

Stainless Steel Finishing

DE-936

Royal Blue

DE-937

DE-938

DE-939

DE-940

DE-941

DE-942

DE-943

DE-944

DE-945

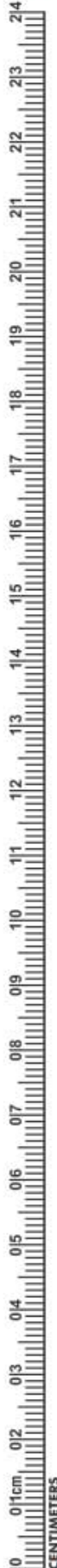
DE-946
 Nakawalni
 Dental Laboratory
 Instrument

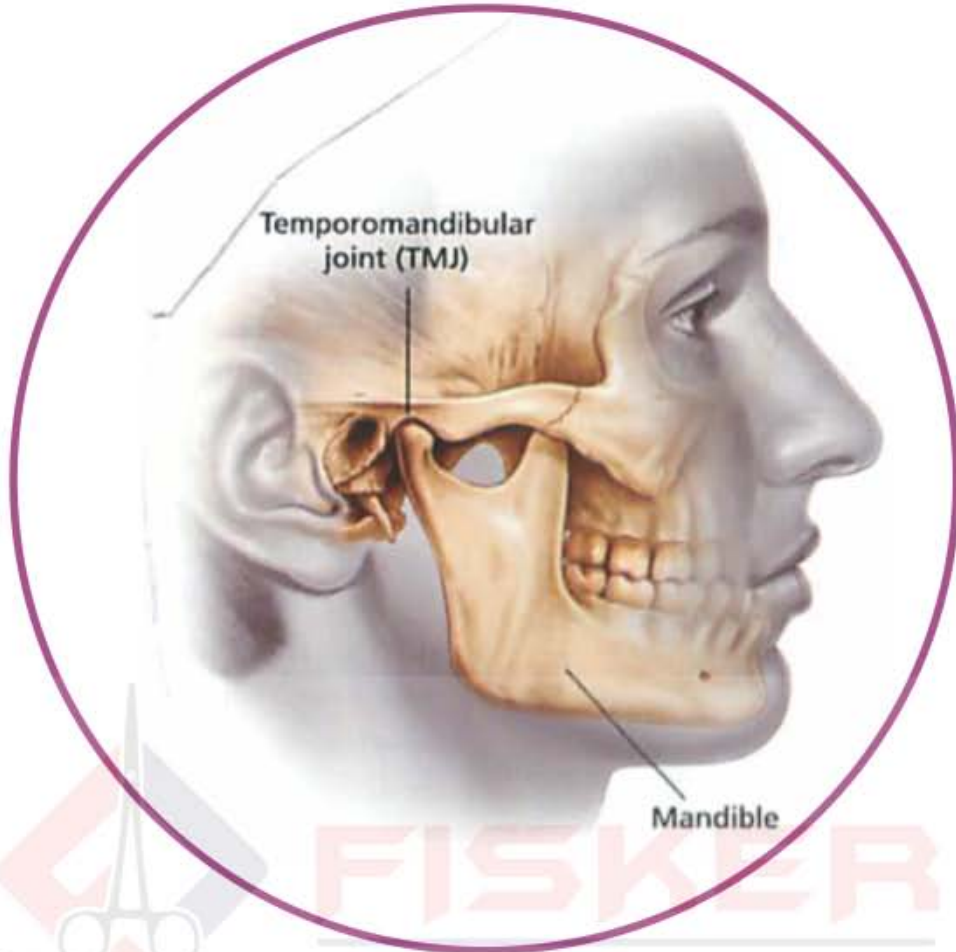

- Роторасширители
- Ecarteurs - Ouvre-bouches
- Vestibulumabhalter / Mundspanner
- Роторозширювачі
- Separadores - Abre-bocas
- الكاشطات - الكمامات الفم



DE-947
Mouth Gag Molt
11 cm for (Children)



DE-948
Mouth Gag Molt
14 cm for (Adults)



Cheek Retractor
DE-949 140 mm
DE-950 180 mm



Cheek Retractor
DE-951 140 mm



DE-952
Wangen Holder,
vestibule
15 cm, with or without
lip protection,



DE-953
Wangen Holder,
vestibule 15 cm, with
or without lip protection,



DE-954
Wangen Holder
Wangen holder with dual
function, 17 cm,



DE-955
140 mm



DE-956
150 mm



Cheek Retractor



RETRACTORS - MOUTH GAGS

- Роторасширители
- Ecarteurs - Ouvre-bouches
- Vestibulumabhalter / Mundspanner
- Роторозширювачі
- Separadores - Abre-bocas
- الكاشطات - الكمامات الفم



DE-957
Fig. 1
weitlaner
10.5cm
13.5cm



DE-958
Fig. 2
weitlaner
10.5cm
13.5cm



DE-959
Stainless Steel
Double
Ended Cheek
Retractors



DE-960
Stainless Steel
Single
Ended Cheek
Retractors



Weitlander
DE-961 11cm
DE-962 13cm
DE-963 15cm



DE-967
Denhard
12 cm



DE-968
Roser-König
16 cm



DE-969
Roser-König
19 cm



Jennings
DE-964 11cm
DE-965 13cm
DE-966 15cm





Wound, Bendable
Retractor, individually or as saving kit!

- Ранорасширители
 - Ecarteurs
 - Wundhaken
- Ранорозширювачі
 - Separadores
 - الكاشحات



DE-970
Cheek Retractor
Long



DE-971
Cheek Retractor
Long



DE-972
Cheek Retractor
Long



Retractor with
Ergo Grip
DE-973 24 cm,
ergonomic handle,



DE-974
Cheek Retractors,
Retractor Ivory
Width adjustable
& fixable, 20 cm,



Cheek Retractors,
tongue depressors
DE-975 19 cm



Cheek Retractors,
Minnesota
DE-976 16 cm



Cheek Retractors,
DE-977 20 cm
easy to bend
by hand,



Cheek Retractors,
retractor and tongue
pushers BISHOP with
comfortable margin,
DE-978 16 cm,



Retractors Cheek
retractor combination
Combination,
DE-979 25 cm,

RETRACTORS

- Ранорасширители
- Ecarteurs
- Wundhaken
- Ранорозширювачі
- Separadores
- الكاشطات



DE-982
Retractors, Unique
Length 175 mm,
angled 45 °



DE-983
Retractors, Unique
Length 175 mm,
angled 90°



DE-984
Retractors
16cm



DE-985
Retractors
19cm



DE-986
Retractors, Mini-Langenbeck
16 cm, hooks 22 mm,



DE-987
Retractors, Cheek
retractors combination
21 cm, 2



DE-988
Mini Retractor
about 8 cm,



DE-989
Retractors
17 cm, hooks 22 mm



- Ранорасширители
- Ecarteurs
- Wundhaken
- Ранорозширювачі
- Separadores
- الكاشطات



30 x 16 mm

DE-990
Retractors, surgical-flat
 surgically-flat, 21 cm, hook
 30x16 mm,



DE-991
Retractors, surgical-flat
 surgically-flat, 21 cm, hook
 42x11 mm



60 x 12 mm

DE-992
Retractors, surgical-flat
 surgically-flat, 21 cm, hook
 63x12 mm,



Retractors, surgical-flat
 surgically-flat, 21 cm, hook
DE-993 30x16 mm,
DE-994 42x11 mm,
DE-995 63x12 mm,



Retractors, Langenbeck
 21 cm, hook
DE-996 30x11 mm,
DE-997 30x16 mm,



DE-998
Retractors
 21 cm,



DE-999
Farabeuf
 (120 X 12mm)
 Set of 2 pices)



DE-1000
Retractor Seldin



DE-1001
FELDMAN
RETRACTOR
 5-1/2", 14cm



GUM SCISSORS

- Ножницы десневые
- Ciseaux a gencives
- Zahnfleischscheren
- Ножиці для ясен
- Tijeras para encias
- مقص صمغ



DE-1002
Iris
115mm
Straight



DE-1003
Iris
115mm
Curved



DE-1004
Goldman-Fox
130mm
Saw edge, straight



DE-1005
Goldman-Fox
130mm
Saw edge, Curved



DE-1006
La Grange
115mm
Saw edge, double Curved



Mayo
DE-1007 140mm
DE-1008 170mm
DE-1009 230mm
Straight



Mayo
DE-1010 140mm
DE-1011 170mm
DE-1012 230mm
Curved



Metzenbaum
DE-1013 145mm
DE-1014 180mm
DE-1015 200mm
Straight



Metzenbaum
DE-1016 145mm
DE-1017 180mm
DE-1018 200mm
Curved



DE-1019
Kelly
160mm
Straight



DE-1020
Kelly
160mm
Curved



DE-1021
Iris
115mm
Straight



DE-1022
Iris
115mm
Curved



DE-1023
La Grange
115mm
Double Curved



DE-1024
Goldman-Fox
130mm, Straight



DE-1025
Goldman-Fox
130mm, Curved



DE-1026
Kelly
160mm, Curved



DE-1027
Iris
115mm, Straight



DE-1028
Iris
115mm, Curved



DE-1029
Micro Iris
90mm, Curved



- Ножницы десневые
- Ciseaux a gencives
- Zahnfleischscheren

- Ножщи для ясен
- Tijeras para encias
- مقص صمغ

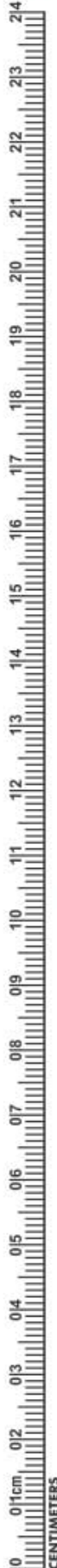

DE-1030
Iris
115mm
Angled



DE-1031
Iris
115mm
Curved



DE-1032
Goldman-Fox
130mm
Saw edge,
straight



DE-1033
Goldman-Fox
130mm
Saw edge,
curved



DE-1034
Goldman-Fox
130mm
Saw edge,
double curved



DE-1035
La Grange
115mm
Saw edge,
double curved



DE-1036
Neumann
120mm
Saw edge,
double curved



DE-1037
Kilner (Ragnell)
120mm
Straight



DE-1038
Kilner (Ragnell)
120mm
Curved



DE-1039
Joseph
140mm
Straight



DE-1040
Joseph
140mm
Curved



DE-1041
Kelly
160mm
Straight



DE-1042
Kelly
160mm
Curved



DE-1043
Locklin
160mm
Saw edge,
angular



DE-1044
Locklin
160mm
Saw edge,
angular



DE-1045
Dean
170mm
Saw edge,
angular



DE-1046
Spencer
90mm



DE-1047
Spencer
130mm



DE-1048
Spencer
115mm



DE-1049
Noyes
110mm, Straight



DE-1050
Noyes
110mm
Curved



DE-1051
Noyes
110mm
Angular



DE-1052
Castroviejo
150mm
Curved

NEEDLE HOLDERS

- Иглодержатели
 - Porte-aiguilles
 - Nadelhalter
- Голкотримачи
 - Porta-agujas
 - أصحاب إبرة



DE-1053
130mm
Straight



DE-1054 Mayo
DE-1055 Mayo
DE-1056 Mayo
130mm 130mm
160mm 160mm
180mm 180mm
Straight Curved



DE-1057 Mayo
DE-1058 Mayo
140mm 140mm
200mm 200mm
Straight Curved



DE-1059 Metzenbaum
DE-1060 Metzenbaum
145mm 145mm
200mm 200mm
Straight Curved



DE-1061
Beebee
110mm
Saw edge,
straight



DE-1062
Beebee
110mm
Saw edge,
curved



DE-1063
Beebee
110mm
Saw edge, straight



DE-1064
Beebee
110mm
Saw edge, curved



DE-1065
Universal
120mm
Saw edge



DE-1066
Universal
120mm



Crile
DE-1067 130mm
DE-1068 150mm
DE-1069 180mm



DE-1070
Halsey
130mm



DE-1071
Baumgartner
130mm



DE-1072
Derf
120mm



DE-1073
Delicate
150mm



Mayo-Hegar
DE-1074 130mm
DE-1075 160mm
DE-1076 180mm
DE-1077 200mm



DE-1078
Crile-Wood
150mm
straight



DE-1079
Crile-Wood
150mm
curved



- Иглодержатели
- Porte-aiguilles
- Nadelhalter

- Голкотримачи
- Porta-agujas
- اصحاب ابرة



Castroviejo
DE-1080 130mm
DE-1081 150mm
DE-1082 180mm



DE-1083
 Halsey
 130mm



DE-1084
 Baumgartner
 130mm



DE-1085
 Derf
 120mm



DE-1086
 Delicate
 150mm



DE-1087
 Adson
 170mm



Mayo-Hegar
DE-1088 130mm
DE-1089 160mm
DE-1090 180mm
DE-1091 200mm



DE-1092
 Crile-Wood
 150mm



Castroviejo
DE-1093 str 140mm cvd
DE-1094 str 180mm cvd



Olsen-Hegar Needle
 Holder With Scissors
DE-1095 140mm



Gillies Needle
 Holder With Scissors
DE-1096 160mm



Mathieu
DE-1097 140mm
DE-1098 170mm



Castroviejo
DE-1099 str 140mm cvd
DE-1100 str 180mm cvd



Olsen-Hegar Needle
 Holder With Scissors
DE-1101 140mm



Gillies Needle
 Holder With Scissors
DE-1102 160mm

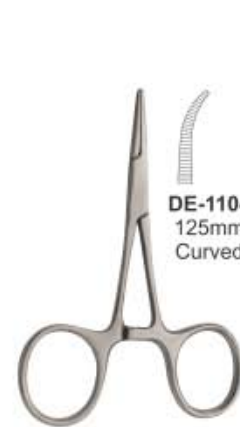

Hartmann (Baby
 Mosquito)
DE-1103 90mm straight



Halstead Mosquito
DE-1105 125mm
 Straight

DE-1106
 Curved

HAEMOSTATIC FORCEPS & TOWEL CLAMPS

- Зажимы артериальные, зажимы для салфеток
- Pincas hemostatiques, Pincas a compresas
- Arterienklemmen, Tuyschklemmen
- Затискачі артеріальні, затискачі для серветок
- Pinzas hemostaticas, Pincas para compresas
- الملقط هيموستاتيک المذبك منشفة

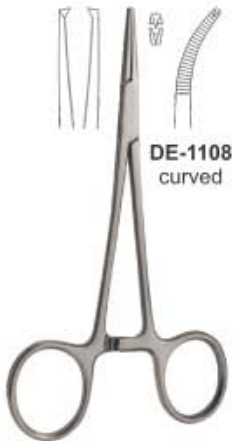

DE-1108
curved

Halstead Mosquito 1x2
DE-1107 125mm
straight

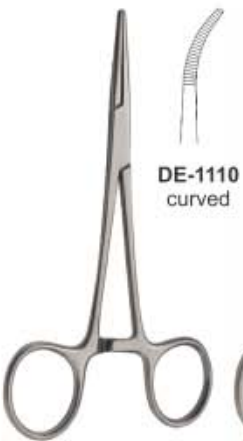

DE-1110
curved

Kelly
DE-1109 140mm
straight



DE-1115 140mm
DE-1116 160mm
DE-1117 180mm
DE-1118 200mm
curved

Rochester-Pean
DE-1111 140mm
DE-1112 160mm
DE-1113 180mm
DE-1114 200mm
straight



DE-1123 140mm
DE-1124 160mm
DE-1125 180mm
DE-1126 200mm
curved

Rochester-Kocher 1x2
DE-1119 140mm
DE-1120 160mm
DE-1121 180mm
DE-1122 200mm
straight



DE-1128
curved

DE-1127
Kelly-Rankin
160mm
straight



Lorna
DE-1129 100mm
DE-1130 130mm



DE-1131
Allis-Baby 3:4
150mm



DE-1132
Allis 4:5
200mm

DE-1133
Allis 6:7
200mm

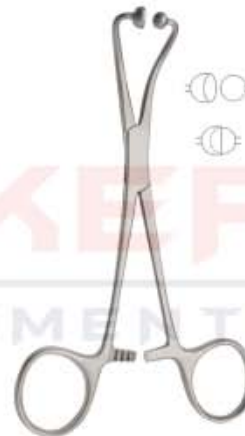

Backhaus
DE-1134 140mm
Not-perforating and
not-damaging



DE-1135
Backhaus
130mm



DE-1136
Backhaus
85mm



DE-1137
Jones
90mm

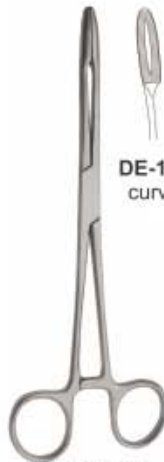

Gross Maier
Dressing Forceps
DE-1138 200mm straight

DE-1139
curved



Foerster
Dressing Forceps
DE-1140 200mm



Young
Tongue Forceps
DE-1141 170mm

Spare rubber



Collins
Tongue Forceps
DE-1142 170mm



- Инструменты для системы коффердам
 - Pincas porte-crampons a digue
 - Kofferdam Klammerzangen
- Инструменти для системи коффердам
 - Pinzas de engrapar para dique de caucho
 - السد المطاط الملتقط المشابك

DE-1143

On request the Content of the rubber dam kit can be changed with other instruments.

Content:

- 01 Anisworth
- 02 Brewer
- 03 Clamps Stand
- 04 Denture Plate
- 05 Rubber Dam Frame
- 06 Rubber Dam Box Lower Case
- 07 Rubber Dam Box Upper Case
- 08 Rubber Dam Clamp Fig. 212
- 09 Rubber Dam Clamp Fig. 211
- 10 Rubber Dam Clamp Fig. 8
- 11 Rubber Dam Clamp Fig. 8A
- 12 Rubber Dam Clamp Fig. 14
- 13 Rubber Dam Clamp Fig. 14A
- 14 Rubber Dam Clamp Fig. 0
- 15 Rubber Dam Clamp Fig. 00
- 16 Rubber Dam Clamp Fig. 2
- 17 Rubber Dam Clamp Fig. 2A
- 18 Rubber Dam Clamp Fig. 7

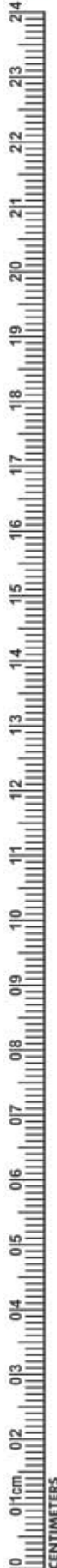
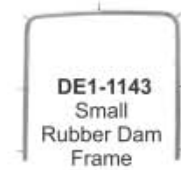

RUBBER DAM CLAMPS

- Кламмера для коффердама
- Crampons pour digue
- Kofferdam Klammern
- Кламмера для коффердама
- Grapas para dique de caucho
- المشابك السد المطاط



DE-1149
Fig. 15



DE-1150
Fig. 18



DE-1151
Fig. 24



DE-1152
Fig. 25



DE-1153
Fig. 26



DE-1154
Fig. 28



DE-1155
Fig. 30



DE-1156
Fig. 31



DE-1157
Fig. 51



DE-1158
Fig. 138



DE-1159
Fig. 139



DE-1160
Fig. 200



DE-1161
Fig. 201



DE-1162
Fig. 202



DE-1163
Fig. 203



DE-1164
Fig. 204



DE-1165
Fig. 205



DE-1166
Fig. 3



DE-1167
Fig. W3



DE-1168
Fig. 4



DE-1169
Fig. 56A



DE-1170
Fig. 7



DE-1171
Fig. 7A



DE-1172
Fig. 8



DE-1173
Fig. 8A



DE-1174
Fig. W8A



DE-1175
Fig. 10



DE-1176
Fig. 11



DE-1177
Fig. 12A



DE-1178
Fig. 13A



DE-1179
Fig. 14



DE-1180
Fig. 14A



DE-1181
Fig. 14AN



DE-1182
Fig. 22



DE-1183
Fig. 27



DE-1184
Fig. 207



DE-1185
Fig. 29



DE-1186
Fig. 206



DE-1187
Fig. 208



DE-1188
Fig. 209



DE-1189
Fig. 1



DE-1190
Fig. 1A



DE-1191
Fig. 2



DE-1192
Fig. 2A



DE-1193
Fig. W2A



DE-1194
Fig. 0



DE-1195
Fig. 00



DE-1196
Fig. 210



DE-1197
Fig. 211



DE-1198
Fig. 212



DE-1199
Fig. 6



DE-1200
Fig. 9



DE-1201
Fig. N06



DE-1202
Fig. U67



DE-1203
Fig. 214



DE-1204
Fig. P1



DE-1205
Fig. P2



DE-1206
Fig. G-1



DE-1207
Fig. G-2



- Инструменты для удаления коронок
- Attache-couronnes
- Teleskopkronenzangen

- Инструменти для видалення коронок
- Arranca-corona
- مزيلات التاج



DE-1210
Crown Spreaders



DE-1211
Mershon
14 cm
Band Pusher



DE-1212 Fig. 0
Manual Crown Removers
Handle with 3 tips **DE1-1212**
Only 3 tips **DE2-1212 to DE4-1212**



DE2-1212



DE3-1212



DE4-1212



DE6-1212



Manual Crown Removers
Handle with 3 tips **DE5-1212**
Only 3 tips **DE6-1212 to DE8-1212**



DE7-1212



DE8-1212



DE-1213
Manual Crown Remover



DE-1214
Complete with 3 tips
and tightening keys



semi-automatic crown
& bridge remover



DE-1215



DE-1216
Manual Crown Remover



MATRIX RETAINERS

- Матрицедержатели
- Porte Matrices
- Matrizenspanner

- Матрицеутримувачи
- Porta Matrices
- مصفوفة الخدم



DE-1217
Fig. 5
Ivory 8
5 cm



DE-1218
Fig. 6
Ivory 8
6 cm



DE-1219
Fig. 7
Ivory 8
7 cm



DE-1220
Fig. 1
Tofflemire-Universal



DE87-1220



DE1-1220



DE2-1220

Siqveland Retainers



DE-1221
Fig. 2
Tofflemire-Junior



DE-1222
Fig. 3
Tofflemire-Senior



DE-1223
Narrow



DE-1224
Wide

Amalgam Well



DE-1225
Stainless Steel
Amalgam Well



DE-1226
Ivory 12



DE-1227
Ivory 1



DE-1228
Ivory



DE-1229
Elliot



Инструменты для амальгамы
 • Instruments pour amalgame
 • Amalgamis/instrumente

• Инструменты для амальгами
 • Instrumentos para amalgama
 • الصوك المنغم

• Ручки для скальпелей
 • Manches de bistouris
 • Skalpellgriffe

• Ручки для скальпелів
 • Mangos de bisturi
 • مشرط مقابض

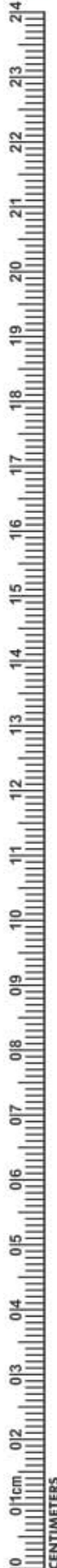

Ø 2mm

DE-1230
 Fig. 10
 165mm
 English pattern



Ø 2mm

DE-1231
 Fig. 1
 185mm
 German pattern



Ø 2mm

DE-1232
 Fig. 1
 150mm
 Swiss pattern



Ø 2mm

DE-1233
 Fig. 1
 150mm



Ø 2mm

DE-1234
 Fig. 2
 150mm, 45°



Ø 2mm

DE-1235
 Fig. 3
 140mm, 90°



DE-1236
 Fig.3
 5" (12.7cm)



DE-1237
 Fig.3G
 5" (12.7cm)



DE-1238
 Fig.4
 5 1/2" (13.7cm)



DE-1239
 6 Way Adjustable Angled
 Scalpel Handle



Locks At 90°, 60°, 30°,
 Straight, 120°, 150°, 180°,
 Angles

- Инструменты для амальгамы
- Instruments pour amalgame
- AmalgamisInstrumente
- Инструменти для амальгами
- Instrumentos para amalgama
- الصكوك الملقم

AMALGAM CARRIERS

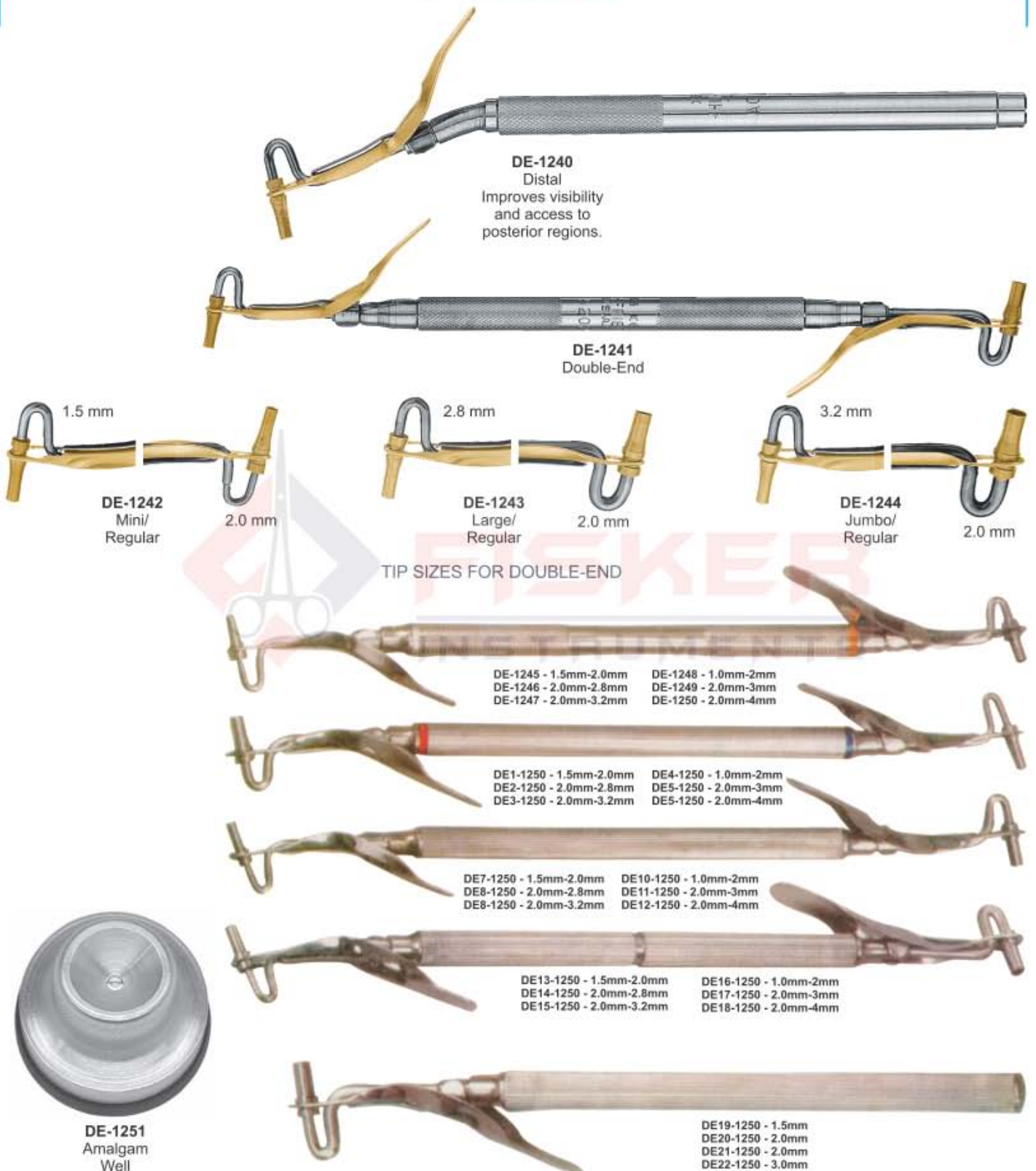

DE-1240
Distal
Improves visibility and access to posterior regions.

DE-1241
Double-End

DE-1242
Mini/
Regular

DE-1243
Large/
Regular

DE-1244
Jumbo/
Regular

TIP SIZES FOR DOUBLE-END

DE-1245 - 1.5mm-2.0mm DE-1248 - 1.0mm-2mm
DE-1246 - 2.0mm-2.8mm DE-1249 - 2.0mm-3mm
DE-1247 - 2.0mm-3.2mm DE-1250 - 2.0mm-4mm

DE1-1250 - 1.5mm-2.0mm DE4-1250 - 1.0mm-2mm
DE2-1250 - 2.0mm-2.8mm DE5-1250 - 2.0mm-3mm
DE3-1250 - 2.0mm-3.2mm DE5-1250 - 2.0mm-4mm

DE7-1250 - 1.5mm-2.0mm DE10-1250 - 1.0mm-2mm
DE8-1250 - 2.0mm-2.8mm DE11-1250 - 2.0mm-3mm
DE8-1250 - 2.0mm-3.2mm DE12-1250 - 2.0mm-4mm

DE13-1250 - 1.5mm-2.0mm DE16-1250 - 1.0mm-2mm
DE14-1250 - 2.0mm-2.8mm DE17-1250 - 2.0mm-3mm
DE15-1250 - 2.0mm-3.2mm DE18-1250 - 2.0mm-4mm

DE19-1250 - 1.5mm
DE20-1250 - 2.0mm
DE21-1250 - 2.0mm
DE22-1250 - 3.0mm

DE-1251
Amalgam
Well



ROOT PLANNING FILES

DE-1252
 Kramer-Nevins
 Bone Chisel



DE-1253
 Kramer-Nevins
 Bone Chisel



DE-1254
 Molt 18.5cm
 Auto Clavable
 Plastic Tips.



DE-1255
 Mead 18.5cm
 Non Auto Clavable
 Plastic Tips.



DE-1256
 Miller



DE-1257
 Miller

BONE FILES

DE-1258
 Miller 21



DE-1259
 Miller 1X
 cross cut



DE-1260
 Miller 2X
 cross cut



DE-1261
 Miller 52



DE-1262
 Wahl 1



- Инструменты пародонтологические
- Instruments pour la parodontologie
- Instrumente für die Parodontologie
- Инструменти пародонтологічні
- Instrumentos para periodoncia
- الصكوك اللثة

PERIOSTEEL ELEVATORS



DE-1263
BUSER

DE-1264
Ohl 10

DE-1265
Howard 9H

DE-1266
Freer

DE-1267
Freer 15

DE-1268
Freer 16

DE-1269
Molt 9

DE-1270
Allen 9A

DE-1271
Prichard 3



DE-1272
Seldin 23

DE-1273
Goldman-Fox
14

DE-1274
P 24G



DE-1275

DE-127A

DE-127B

Raspator, Raspatory
Length 175 mm,



DE-1276

DE-1276A

DE-1276B

Raspator, Williger
Length 170 mm, different widths
(4 mm, 5 mm or 7 mm),





Behind Every Smile is a Story

- QUALITY - ЯКІСТЬ
- PRECISION - ТОЧНІСТЬ
- ACCURACY - ПРАВИЛЬНІСТЬ
- DURABILITY - ЗНОСОСТІЙКІСТЬ



- Super-sharp diamond-bevel cutters
- smooth ultra-polished and rounded edges
- brilliant corrosion resistant stainless steel finish
- super-T12 stainless steel tool inserts
- sliding lock joint for balance & precision alignment
- Super-sharp diamond-bevel cutters
- smooth ultra-polished and rounded edges
- brilliant corrosion resistant stainless steel finish
- super-T12 stainless steel tool inserts
- sliding lock joint for balance & precision alignment

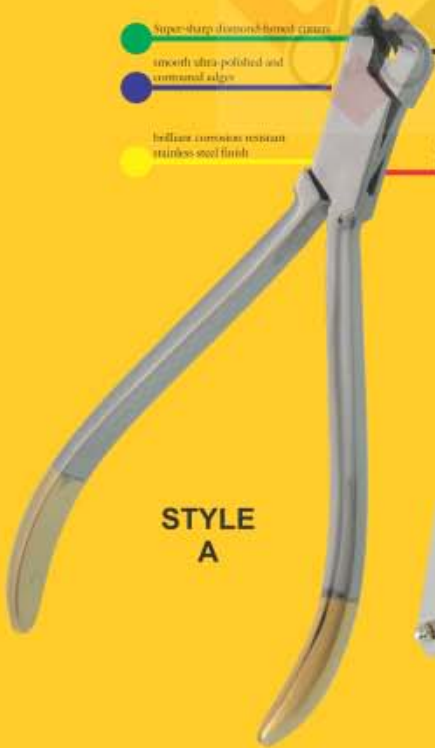

**STYLE
A**

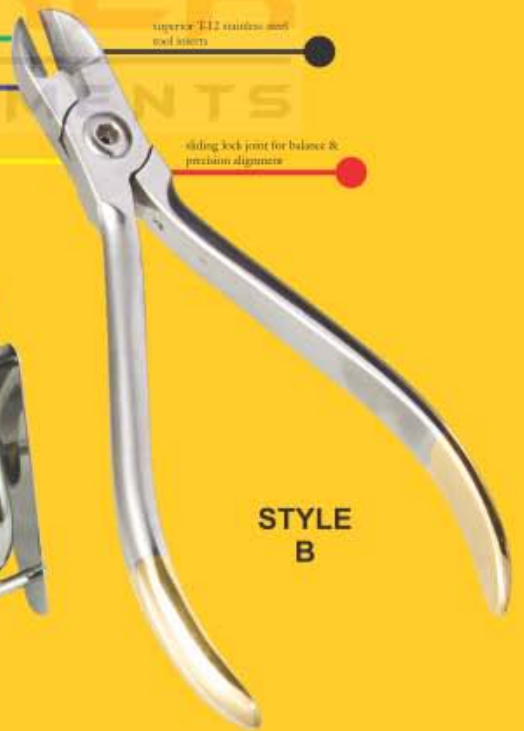

**STYLE
B**



ORTHODONTIC INSTRUMENTS

- Инструменты ортодонтические
- Instrumentos Ortodonticos
- Orthodontische Instrumente
- Инструменти ортодонтични
- Instruments Orthodontiques
- ادوات تقويم الأسنان



DE-1277
Aluminum Height Gauge 0.22

DE-1278
Aluminum Height Gauge 0.18

DE1-1278
Height Gauge Movable



DE-1279
Bone Bracket Gauge



DE1-1279
Endo Finger Ruler Span Measure Scale



DE2-1279
Endo Finger Ruler Span Measure Scale

DE3-1279
Endo Finger Ruler Span Measure Scale



DE4-1279
Compasso De Willis



DE-1280
Bone Thickness Gauge
40mm, 180mm



DE-1281
Osteometer Measuring Forceps



DE-1282
Bracket Placer Tweezers
(Extra Fine Tip)



DE-1283
Direct Bonding Bracket Holders
135mm



DE-1284
Direct Bonding Bracket Holders
136mm



DE-1285
Direct Bonding Bracket Holders
135mm



DE-1286
Deluxe Bracket Holder



DE-1287
Deluxe Bracket Holder Tweezers

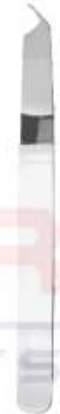

DE-1288
Deluxe Bracket Holder Tweezers



DE1-1288
Bracket Tweezers Slot Aligner



DE2-1288
Direct Bonding Bracket Holders
140mm



DE3-1288
Bracket Placing Tweezes



DE4-1288
Easy Access Tweezes



DE5-1288
Direct Bonding Bracket Holders
140mm



DE6-1288
Direct Bond Bracket Holder Tweezers
Small Tip



DE7-1288
Exact Bracket Holder Tweezers



DE8-1288
Easy Eccess Tweezes



DE9-1288
Slipper Tweezers



- Инструменты ортодонтические
- Instrumentos Ortodonticos
- Orthodontische Instrumente
- Инструменти ортодонтични
- Instruments Orthodontiques
- أدوات تقويم الأسنان



DE-1289
 Band seater auto cleavable



DE-1290
 Ortho light scaler double ended



DE-1291
 Ortho light scaler double ended



DE-1292
 Ortho light scaler double ended



DE-1293
 Twiel-on elastic module instrument



DE-1294
 Twiel-on elastic module instrument



DE-1295
 Schure Band Seater



DE-1296
 Ortho light scaler

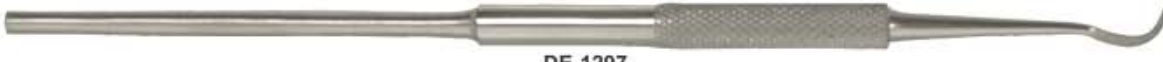

DE-1297
 Ortho light scaler

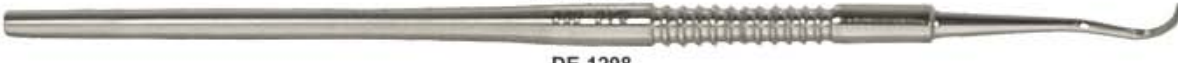

DE-1298
 Ortho light scaler heavy



DE-1299
 Ortho instrument



DE-1300
 Ortho instrument



DE-1301
 Ortho Light Band Pusher Scaler



ORTHODONTIC INSTRUMENTS

- Инструменты ортодонтические
- Instrumentos Ortodonticos
- Orthodontische Instrumente
- Инструменти ортодонтични
- Instruments Orthodontiques
- أدوات تقويم الأسنان



DE-1302
Ortho Light double ended
ligature director



DE-1303
Ortho Light double ended
ligature director scaler



DE-1304
Ortho Light double ended ligature scaler director tivate coil spring
are remove modules with one instruments



DE-1305
Ortho band pusher scaler



DE-1306
Ortho Light Band Pusher Scaler



DE-1307
Ortho ligature director single ended

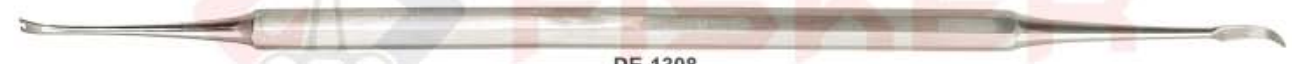

DE-1308
Ortho Light double ended ligature
director scaler



DE-1309
Ortho Light double ended ligature scaler/director
tivate coil spring are remove modules with one instruments



DE-1310
Ortho Light double ended ligature director



DE-1311
Ortholite Ligature Director Scaler



DE-1312
Ortho light ligature director double ended



DE-1313
Double ended cement spatula



DE-1314
Ortho light scaler single ended



- Щипцы для ортодонтии и протезирования
- Pincers pour l'orthodontie et la prothèse
- Zangen für Kieferorthopädie und Prothetik
- Щипці для ортодонції та протезування
- Alicates para ortodoncia y prótesis
- كمامشة لتقويم الأسنان بروتيسيس

BOX JOINT PLIERS

DE-1315
 Universal Dolphin Style
 Wire Bending & cutting pliers



DE-1321
Bracket Removing Plier curved
 Bracket Removing Plier curved for
 easy removal of brackets in the
 posterior region. Length 130mm



DE-1316 Band Removing Plier
 The curved blade of the band
 removing plier can strip easily
 and gently remove directly to
 the tooth. Length 130mm



DE-1322
 Young Wire Bending &
 Loop Forming Pliers



DE-1317
 Tweed Loop
 forming Pliers



DE-1323
 Wire Bending &
 Loop Forming Pliers



DE-1318
How Plier curved
 Universally usable tool for
 the multiband technology for
 wires up to .028".
 Length 130mm



DE-1324
 Adams, small wire bending
 and loop forming Pliers



DE-1319 How Plier
 Universally usable tool for the
 multiband technology for wires
 up to .028".
 Length 135mm



DE-1325
Bracket Removing Plier Round Box
 Bracket removing plier for comfortable
 and quick removal of the brackets.
 Length 135mm



DE-1320
 Nance Loop
 forming Pliers



DE-1326
Weingart Plier medium
 Weingart plier that are ideal due to
 their curved tip for setting sheets and
 is capable of bending the ends.
 Length 145mm



PLIERS FOR ORTHODONTICS & PROSTHETICS

- Щипцы для ортодонтии и протезирования
- Pincers pour l'orthodontie et la prothèse
- Zangen für Kieferorthopädie und Prothetik
- Щипці для ортодонції та протезування
- Alicates para ortodoncia y prótesis
- كمانشة لتقويم الأسنان بروسٹيٹيس

BOX JOINT PLIERS

DE-1327 Adams Plier Round Box

Adams pliers for bending wire arches and bends right angles for wires up to .022", .025 tip to beak. Length 125mm



DE-1333 Adams Plier

Adams pliers for bending wire arches and bends right angles for wires up to .022", .025 tip to beak. Length 125mm



DE-1328

Falcon Beak Contouring Pliers.



DE-1334

Tweed Loop Formin Pliers



DE-1329

wires up to 0.020" / 0.7mm.



DE-1335 Bird Beak Plier Standard

Bird Beak Wire bending plier without notches, which is suitable as a universal utility tool. Length 125mm



DE-1330

Johnson Contouring Pliers



DE-1336

Mini Ligature cutters



DE-1331 Aderer

Large wire bending and loop forming pliers



DE-1337 Small

Fluch-cut distal and cutting Pliers with safety hold fitted with un-breakable, corrosion resistant and durable stainless steel tips



DE-1332

Tweed / angle rectangular arch forming & Torquing pliers



DE-1338 Large

Fluch-cut distal and cutting Pliers with safety hold fitted with un-breakable, corrosion resistant and durable stainless steel tips



- Щипцы для ортодонтии и протезирования
- Pincers pour l'orthodontie et la prothèse
- Zangen für Kieferorthopädie und Prothetik
- Щипці для ортодонції та протезування
- Alicates para ortodoncia y prótesis
- كمامة لتقويم الأسنان بروسیتیس

BOX JOINT PLIERS

DE-1339
Tweed / Angel
 1.78mm (.070") wide tips arch forming and torquing pliers



DE-1345
 Contouring Plier



DE-1340
Tweed / Angel
 1.78mm (.070") wide tips arch forming and torquing pliers



DE-1346
Bands & Crowns Plier
 in order to skirt



DE-1341
Lingual / Palatal arch
 forming pliers



DE-1347
 Ligature Forming Pliers



DE-1342
Aderer
 Facebow loop forming Pliers



DE-1348
 for double back and triple back bands in 0.30" / 0.76mm & 0.36" / 0.91mm lingual arch wires



DE-1343
 Waldsavhs wire bending and cutting pliers



DE-1349
 Bird Beak Wire Bending & cutting pliers



DE-1344 Aderer Plier
 For the manufacturing of appliances and activation of wires for wires up to .030" .fine tip and up to .036" mean tip. Length 130mm



DE-1350
Weingart Plier medium
 Weingart plier that are ideal due to their curved tip for setting sheets and is capable of bending the ends. Length 145mm



PLIERS FOR ORTHODONTICS & PROSTHETICS

- Щипцы для ортодонтии и протезирования
- Pincers pour l'orthodontie et la prothèse
- Zangen für Kieferorthopädie und Prothetik
- Щипці для ортодонції та протезування
- Alicates para ortodoncia y prótesis
- كماشة لتقويم الأسنان بروسٹیٹیس

L-KEY JOINT PLIERS



DE-1351
Distal end cutter with safety hold, mini head, long handles.
fitted with un-breakable, corrosion resistant and durable stainless steel tips

- 0.30 mm to 0.50 mm (.012" to .020")
- Max. 0.46 mm x 0.64 mm (.018" x .025")
- ⊗ 0.38 mm to 0.53 mm (.0155" to .0215")
- ⊗ Max. 0.53 mm x 0.64 mm (.021" x .025")



DE-1352
Flush-cut distal end cutter with safety hold fitted with un-breakable, corrosion resistant and durable stainless steel tips

- 0.30 mm to 0.50 mm (.012" to .020")
- Max. 0.46 mm x 0.64 mm (.018" to .025")



DE-1353
Soft wire and ligature cutter, Mini fitted with un-breakable, corrosion resistant and durable stainless steel tips

- ⌋ .25 mm to .38 mm (.010" to .015")



DE-1354
Soft wire and ligature cutter, standard fitted with un-breakable, corrosion resistant and durable stainless steel tips

- ⌋ .25 mm to .38 mm (.010" to .015")



DE-1355
Soft wire and ligature cutter, 15° angled fitted with un-breakable, corrosion resistant and durable stainless steel tips

- ⌋ .25 mm to .38 mm (.010" to .015")



DE-1356
Soft wire and ligature cutter, 45° angled fitted with un-breakable, corrosion resistant and durable stainless steel tips

- ⌋ .25 mm to .38 mm (.010" to .015")



DE-1357
Hard wire cutter, straight Fitted with un-breakable, corrosion resistant and durable stainless steel tips

- 0.30 mm to 0.50 mm (.012" to .020")
- Max. 0.56 mm x 0.71 mm (.022" x .028")



DE-1358
Hard wire cutter, 15° angled Fitted with un-breakable, corrosion resistant and durable stainless steel tips

- 0.30 mm to 0.50 mm (.012" to .020")
- Max. 0.56 mm x 0.71 mm (.022" x .028")



DE-1359
Hard wire cutter, 15° angled Non-autoclavable

- 0.30 mm to 0.50 mm (.012" to .020")
- Max. 0.56 mm x 0.71 mm (.022" x .028")



- Щипцы для ортодонтии и протезирования
- Pincers pour l'orthodontie et la prothèse
- Zangen für Kieferorthopädie und Prothetik

- Щипці для ортодонції та протезування
- Alicates para ortodoncia y prótesis
- كمامة لتقويم الأسنان بروسیتیس

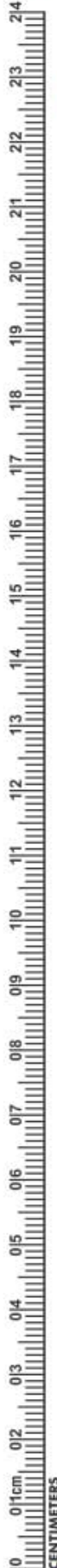
L-KEY JOINT PLIERS

DE-1360
 Band removing pliers

DE-1365
 Weingart-mini
 Utility Pliers

- 0.30 mm to 0.50 mm (.012" to .020")
- Max 0.56 mm x 0.71 mm (.022" x .028")

DE-1361
 Bracket removing pliers angled

DE-1366
 Weingart
 Utility Pliers

- 0.30 mm to 0.50 mm (.012" to .020")
- Max 0.56 mm x 0.71 mm (.022" x .028")

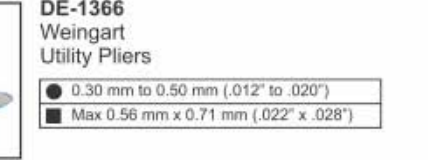
DE-1362
 Bracket removing pliers straight

DE-1367
 How Straight
 Utility Pliers

- 0.30 mm to 0.50 mm (.012" to .020")
- Max 0.56 mm x 0.71 mm (.022" x .028")

DE-1363
 Bracket removing pliers with plastic tip

DE-1368
 Angled
 Utility Pliers

- 0.30 mm to 0.50 mm (.012" to .020")
- Max 0.56 mm x 0.71 mm (.022" x .028")

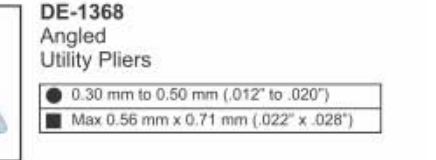
DE-1364
 Adhesive removing pliers

DE-1369
 Wire bending and loop forming pliers
 Angled (Bird beak)

- 0.30 mm to 0.50 mm (.012" to .020")
- Max 0.56 mm x 0.71 mm (.022" x .028")



PLIERS FOR ORTHODONTICS & PROSTHETICS

- Щипцы для ортодонтии и протезирования
- Pincers pour l'orthodontie et la prothèse
- Zangen für Kieferorthopädie und Prothetik
- Щипці для ортодонції та протезування
- Alicates para ortodoncia y prótesis
- كمشاة لتقويم الأسنان بروسيثيس

L-KEY JOINT PLIERS



DE-1370
Multi-purpose pliers, bird beak,
De la rosa and cutter in one

- 0.30 mm to 0.50 mm (.012" to .020")
- Max. 0.46 mm x 0.56 mm (.018" x .022")



DE-1375
Stop pliers V-Bebd - 1mm

- 0.30 mm to 0.50 mm (.012" to .020")
- Max. 0.43 mm x 0.56 mm (.017" x .028")



DE-1371
Cinch Back / tie back
Distal end bending pliers

- 0.30 mm to 0.50 mm (.012" to .020")
- Max. 0.56 mm x 0.71 mm (.022" x .028")



DE-1376
Lingual / palatal arch forming plies

- 0.76 mm (.030") / 0.91 mm (.036")



DE-1372
Hammer head
Distal end bending pliers

- 0.30 mm to 0.50 mm (.012" to .020")
- Max. 0.56 mm x 0.71 mm (.022" x .028")



DE-1377
Torquing pliers set



DE-1373
Nance
Loop forming pliers

- 0.36 mm to 0.71 mm (.014" to .028")
- Max. 0.56 mm x 0.71 mm (.022" x .028")



DE-1378
Tweed / angel
Rectangular arch forming and
torquing pliers

- 0.30 mm to 0.71 mm (.012" to .028")
- Max. 0.56 mm x 0.71 mm (.022" x .028")



DE-1374
Detailing step pliers / Bayonet
bending pliers - 1mm

- 0.30 mm to 0.50 mm (.012" to .020")
- Max. 0.56 mm x 0.71 mm (.022" x .028")



DE-1379
Surgical ball hook crimping pliers,
angled



DE-1380
Surgical ball hook crimping
pliers, straight



- Щипцы для ортодонтии и протезирования
- Pincers pour l'orthodontie et la prothèse
- Zangen für Kieferorthopädie und Prothetik

- Щипці для ортодонції та протезування
- Alicates para ortodoncia y prótesis
- كمامشة لتقويم الأسنان بروسیتیس

L-KEY JOINT PLIERS



DE-1381
 Aderer Clamp three jaw wire bending plier for contouring and bending wire up to .30"/.76mm.

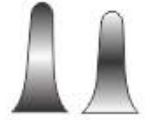

DE-1387
 Falcon beak contouring plier.

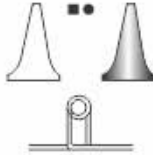

DE-1382
 Bird beak plier for bending round, square and rectangle wire up to .30"/.76mm.



DE-1388
 For placement and removal of arch wires, pins and other auxiliaries.



DE-1383
 Bird beak plier for light wire bending round, square and rectangular up to .016"/0.41mm.

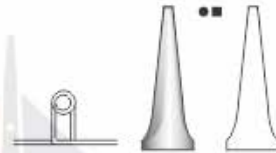

DE-1389
 For placement and removal of arch wires, pins and other auxiliaries in angle design



DE-1384
 Double Rounded jaw bending pliers, hooks and wire up to .020"/0.51mm.

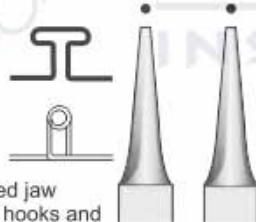

DE-1390
 contouring Plier.



DE-1385
 Adams pliers for hooks and bending wire up to .030"/0.76mm.



DE-1391
 Bending plier. In order to skirt molares bands. With grooved. Recommended wire. 016", 018" and 022" 0.41mm, 0.46mm and 0.56mm



DE-1392
 Loop forming in four length 3,4,5 & 6 mm wire capacity 0.22", 56mm.

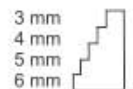

DE-1386
 Johnson pliers for crown band contouring



DE-1393
 Arch bending plier design for convenient handling of square or rectangular wire, .020" / 0.51mm.

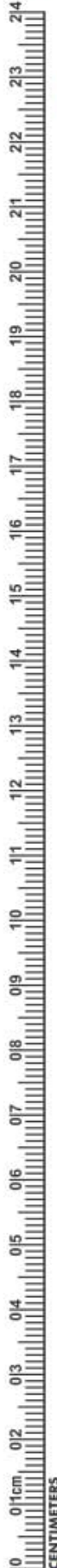

PLIERS FOR ORTHODONTICS & PROSTHETICS

- Щипцы для ортодонтии и протезирования
- Pincers pour l'orthodontie et la prothèse
- Zangen für Kieferorthopädie und Prothetik
- Щипці для ортодонції та протезування
- Alicates para ortodoncia y prótesis
- كمشة لتقويم الأسنان بروسيثيتيس

LAP & L-KEY JOINT PLIERS



DE-1394
In order to skirt bands and crowns.



DE-1395
Wires up to .020" / 0.7mm.

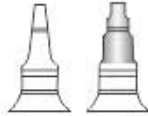

DE-1396
Round and concave plier for loop forming and banding wire up to .20" / .051mm.



DE-1397
Bending for round square or rectangular wire up to 0.30" / 0.76mm



DE-1398
for double back and triple back bands in 0.30" / .76mm & 0.36" / .91mm lingual arch wires.



DE-1399
Detailing step plier double-sided offset beak permits bayonet bends. Creates right hand or left hand step-up or stepdown at 1/2, 3/4, or 1mm increments.



DE-1400
"V" bend stop special design makes 1mm "v" bends to shorten archwires or provide a positive stop. Excellent for placing stops in titanium wires. For round or rectangular wires up to .025"



DE-1401
Angle how plier efficient utility plier with serrated beaks for a firm grip. 45 angled tips to access hard to reach areas.



DE-1402
Weingardt plier serrated tips hold wires firmly at a convenient working angle. Tapered beaks fit easily between brackets and hard to reach areas. Our most popular utility plier.



DE-1415
Pin & Ligature Cutters TC.



DE-1416
Mini Pin & Ligature Cutter TC.



DE-1417
Standard Ligature Cutter TC.



DE-1418
V Bend Stop Plier TC.



DE-1419
Angled Direct Bond Bracket Remover TC.



DE1-1419
Cutter Str.



Distal Cutter
14cm
DE2-1419 2.5 mm
DE3-1419 3.0 mm
DE4-1419 3.0 mm



DE5-1419
Arrow Clasp Forming Pliers
12.0cm



DE6-1419
Schwarz
12.5cm



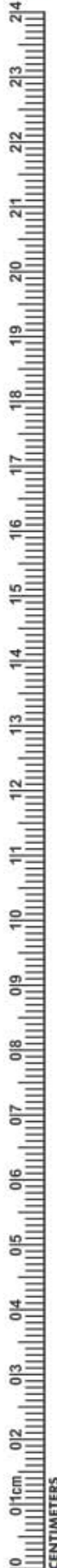

DE-1420
 Distal end Cutter, Safety Hold Plier
 (Ideal for Cutting Wire) TC.



DE-1421
 Hook Crimping Plier Angled
 Straight TC.



DE-1422
 3 Prong Clasp Adjustable
 Plier TC.



DE-1423
 Utility Plier Weingart TC.



DE-1424
 Direct Bracket Remover
 TC.



DE-1425
 Straight Direct Bond Bracket
 Remover TC.



DE-1426
 Pin Holding Plier TC.



DE-1427
 Hard wire cutters



DE-1428
 Elastic Separating Plier
 Round Handle



DE-1429
 Elastic
 Separating Plier



DE-1430
DE-1431
 Smaha
 Elastomeric
 ligature
 placing forceps
 140 mm



DE-1432
 Elastomeric
 ligature placing
 forceps with
 groove
 Falcon 140 mm



DE-1433
 Elastomeric
 ligature placing
 forceps with
 groove
 Falcon 140 mm



Normal Anatomy – Dental Implants

Bone Level Normal
(No Bone Loss)

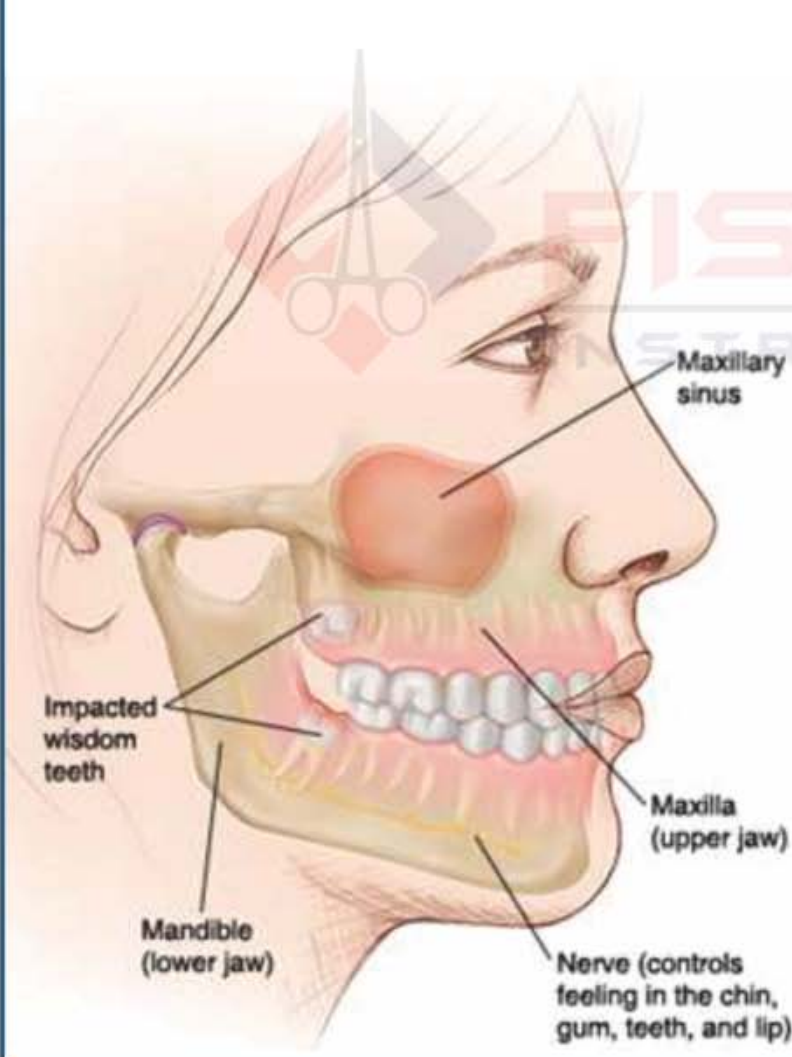
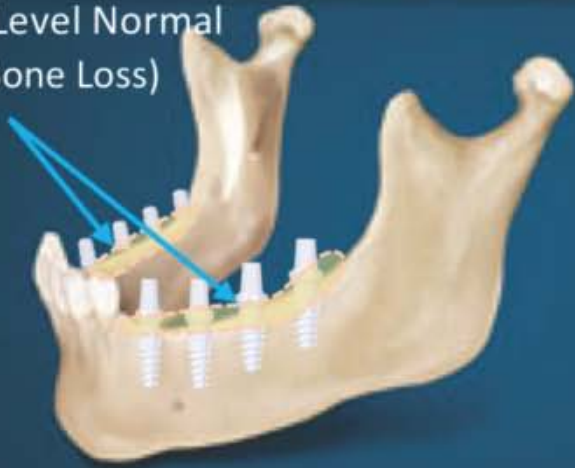

- Инструменты для имплантологии
- Implantologie
- Implantologie

- Інструменти для імплантології
- Implantologia
- زراعة الأسنان

IMPLANT GAGES

DE-1434
Multifunctional Meter
 Length 90 mm,
 different sizes,
 8-10-11mm,
 corrosion-resistant

DE-1435
Multifunctional Meter
 Length 90 mm,
 different sizes,
 5-13-15-17 mm,
 corrosion-resistant

DE-1436
Measuring Probe
 Length 170 mm,
 hand shape or flexible
 (6-8-10-14-16 mm),
 corrosion-resistant

DE-1437

DE-1438

DE-1439

DE-1440

IMPLANT GAGES

DE-1441

DE-1442

DE-1443

- Инструменты для имплантологии
 - Implantologie
 - Implantologie
- Інструменти для імплантології
 - Implantoloia
 - زراعة الأسنان



DE-1444
Clamp, Osteometer
Length about 155 mm,
ridge width measurement,
two-sided scale,
measuring
range 0 - 25 mm



DE-1445
Measuring Loop
straight length 90 mm,
measuring range
0 - 40 mm,



DE-1446
Measuring Loop
angled, length 90 mm,
measuring range
0 - 40 mm,



DE-1447
Measuring loop, Castroviejo
angled, length 175 mm,
measuring range 0 - 40 mm,
with window



DE-1448
Boley Gauge
Stainless Steel



DE-1449
Measuring Loop
angled, length
175 mm,
measuring range
0 - 40 mm,



DE-1450
Measuring Loop
straight length
175 mm,
measuring range
0 - 40 mm,



DE-1451
Fig. 1
Iwanson
spring caliper
For metal and
porcelain.



DE-1452
Fig. 2
Iwanson
spring caliper
For wax.



DE-1453
Bone Thickness Gauge
40mm, 180mm



DE-1454
Gauge
for measuring
distances
(0 - 90 mm),



- Инструменты для имплантологии
- Implantologie
- Implantologie

- Інструменти для імплантології
- Implantologia
- زراعة الأسنان

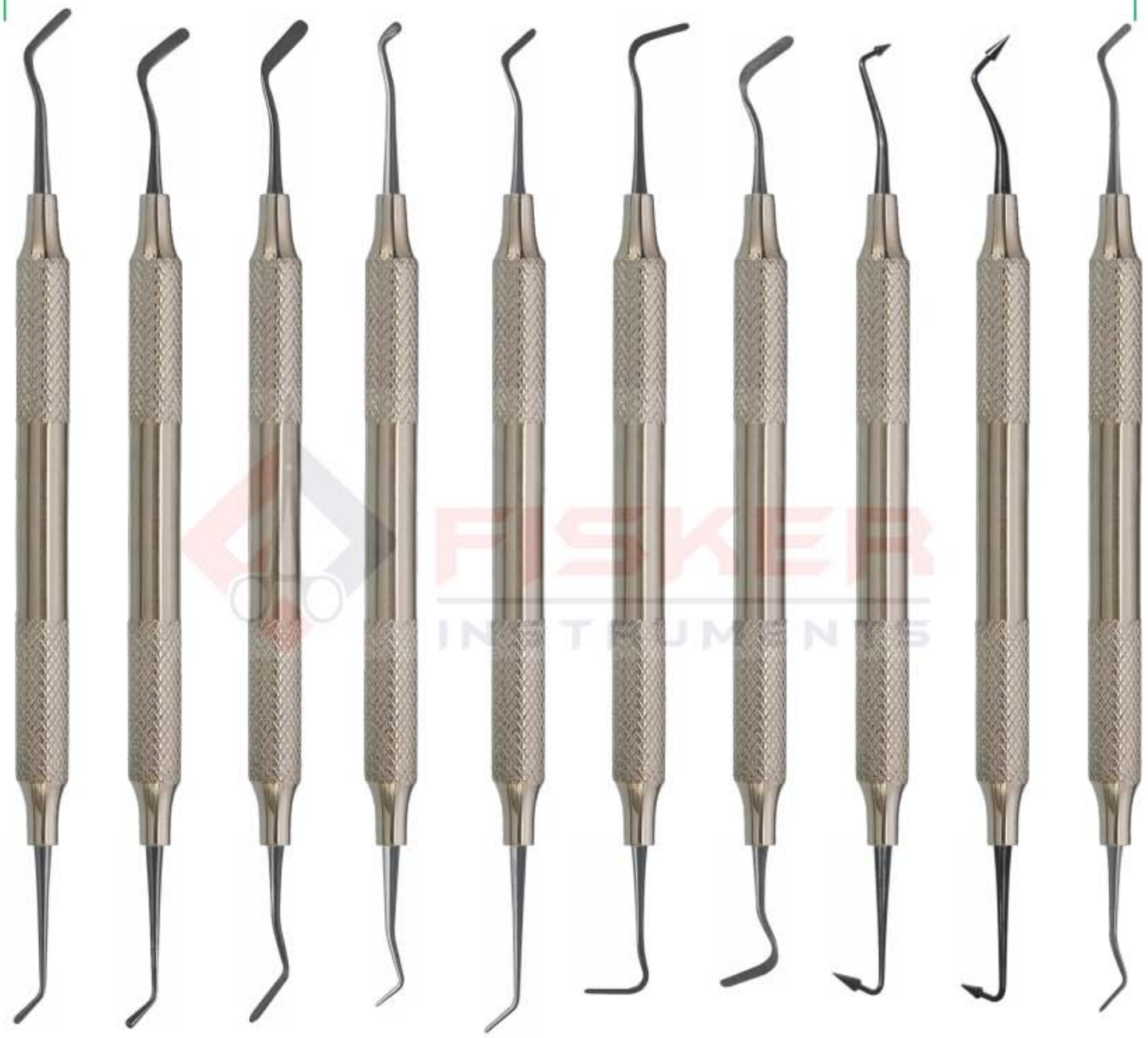
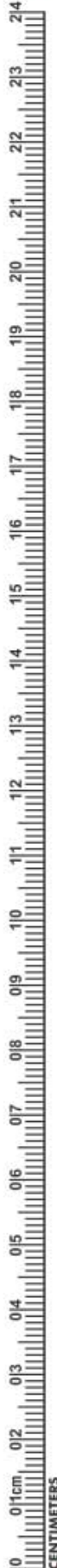
BLACK TITANIUM COLOUR COATED INSTRUMENTS

DE-1455 #1	DE-1456 #2	DE-1457 #3 Extra-Flex	DE-1458 Micro-Mini	DE-1459 Mini 1	DE-1460 Mini 4 Extra-Flex	DE-1461 #4 Extra-Flex	DE-1462 #5 Flexi-Thin	DE-1463 #6 Flexi-Thin	DE-1464 Mini 3 Extra-Flex
---------------	---------------	-----------------------------	-----------------------	-------------------	---------------------------------	-----------------------------	-----------------------------	-----------------------------	---------------------------------

- Инструменты для имплантологии
- Implantologie
- Implantologie
- Інструменти для імплантології
- Implantologia
- زراعة الأسنان

BLACK TITANIUM COLOUR COATED INSTRUMENTS

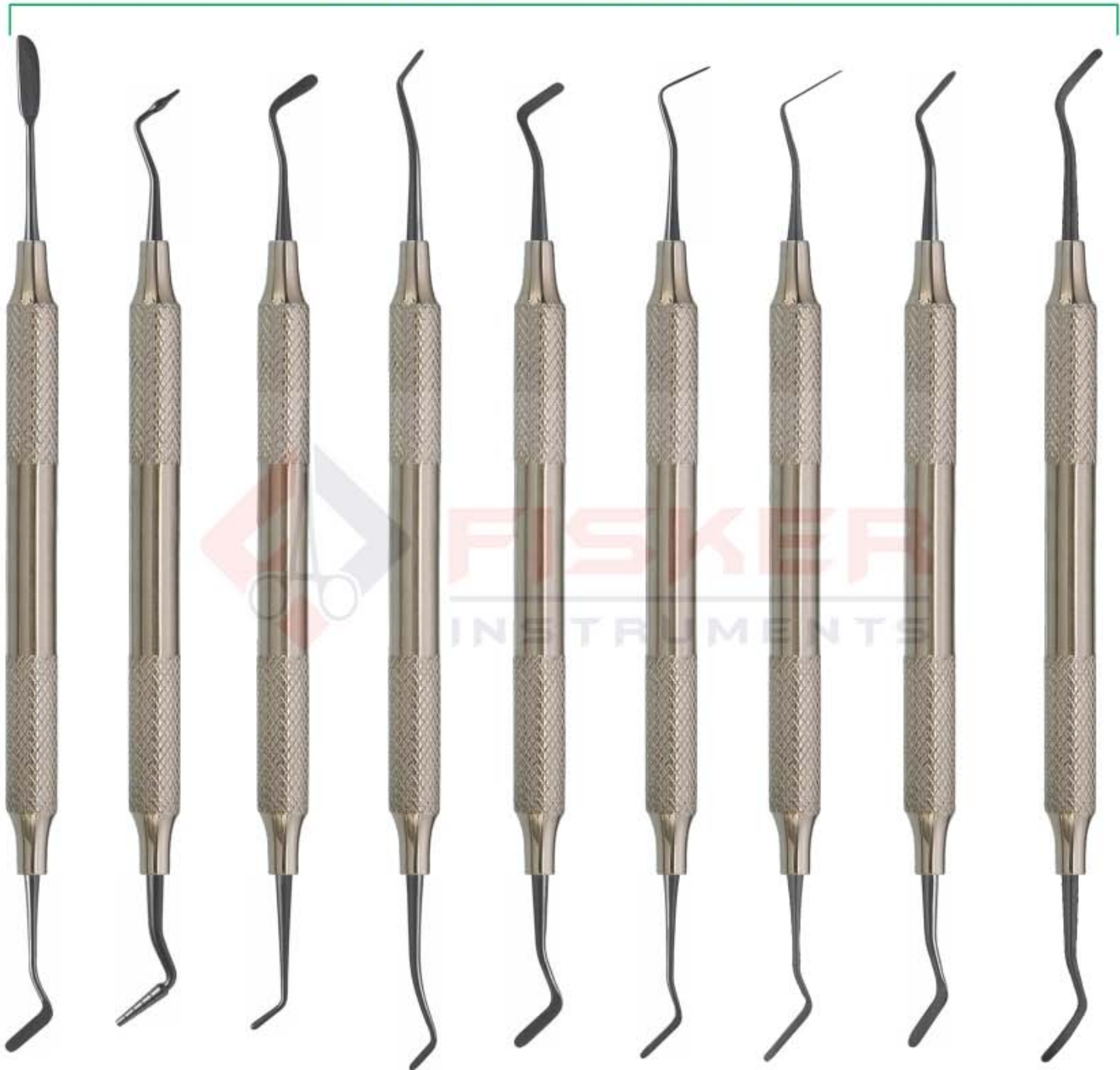

DE-1465
AB1
Boghosian

DE-1466
AB2
Boghosian

DE-1467
W3

DE-1468
8A

DE-1469
4/5
Gregg

DE-1470
Interproximal
Carver

DE-1471
Interproximal
Carver, Long

DE-1472
A6

DE-1473
Contouring
instrument

- Инструменты для имплантологии
- Implantologie
- Implantologie

- Інструменти для імплантології
- Implantologia
- زراعة الأسنان

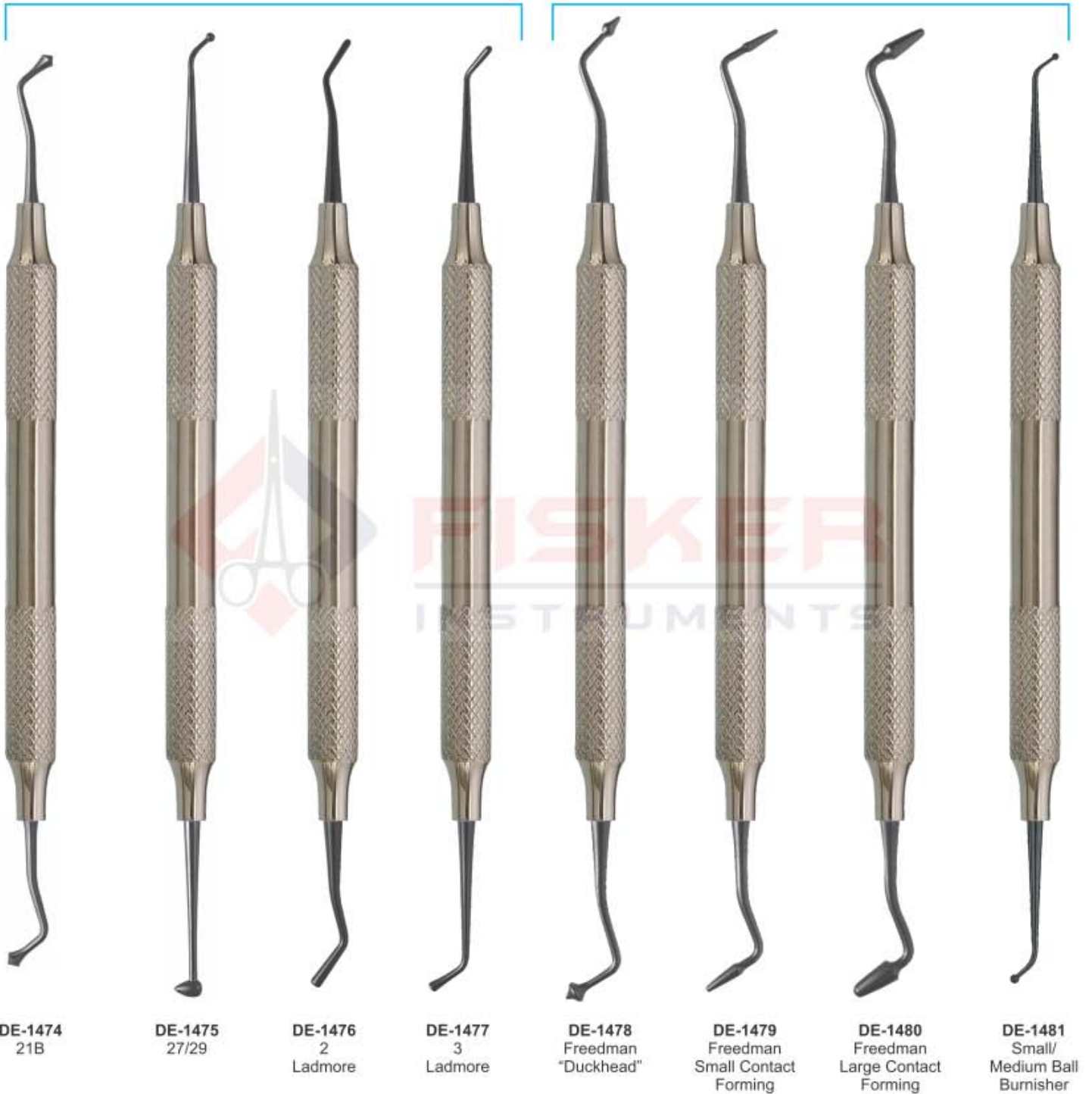
BLACK TITANIUM COLOUR COATED INSTRUMENTS
BURNISHERS
FREEDMAN BURNISHERS

- Инструменты для имплантологии
- Implantologie
- Implantologie
- Інструменти для імплантології
- Implantoloia
- زراعة الأسنان

BLACK TITANIUM COLOUR COATED INSTRUMENTS



DE-1482
A
Cosmetic
Contouring

DE-1483
B
Cosmetic
Contouring

DE-1484
C
Cosmetic
Contouring

DE-1485
D
Cosmetic
Contouring

DE-1486
E
Cosmetic
Contouring

DE-1487
F
Cosmetic
Contouring

DE-1488
Marginal Ridge
& Embrasure
Shaping Instrument

DE-1489
Occlusal
Anatomy
Instrument

DE-1490
Composite
Packing
Instrument



- Инструменты для имплантологии
- Implantologie
- Implantologie

- Інструменти для імплантології
- Implantologia
- زراعة الأسنان

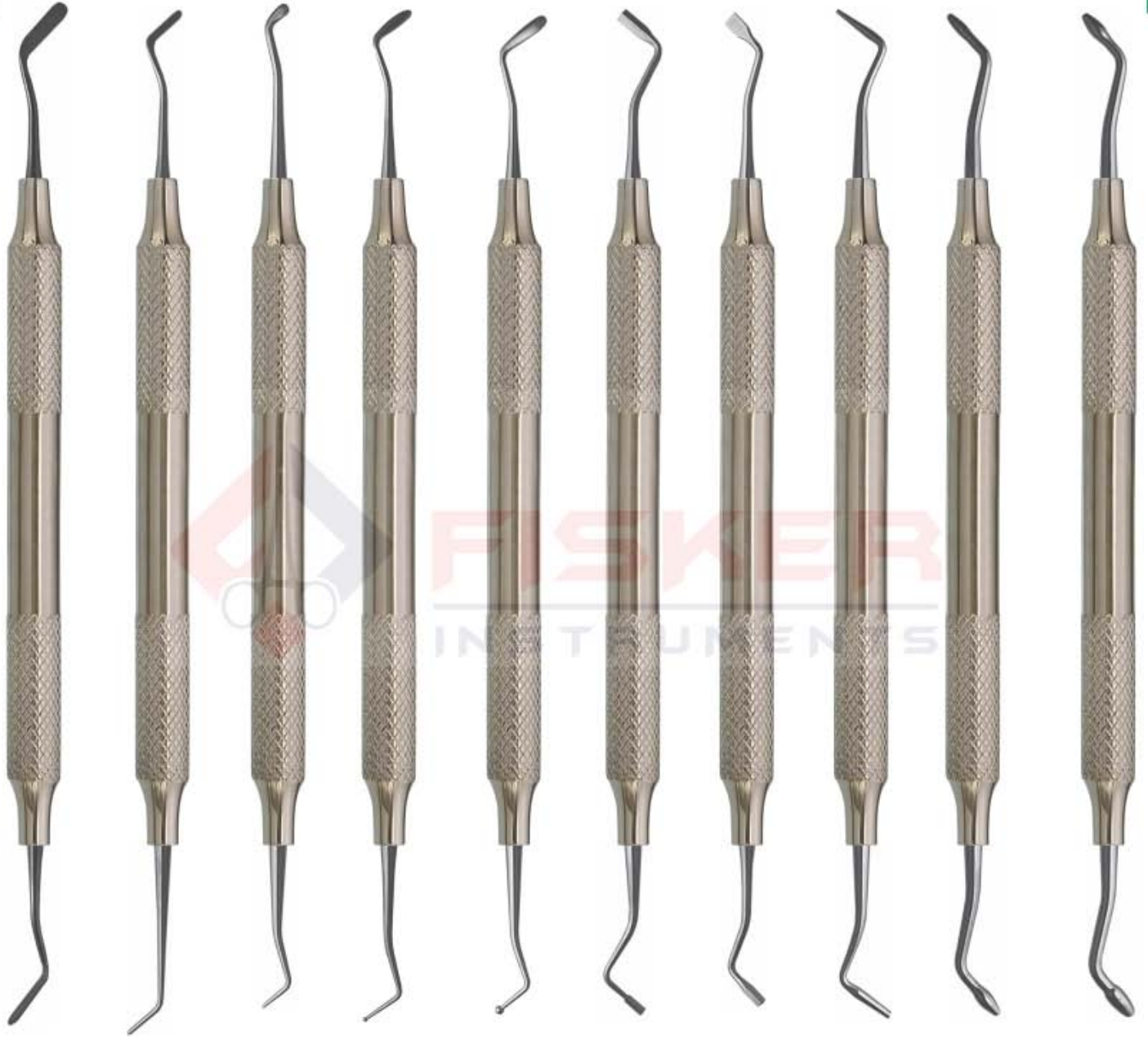
BLACK TITANIUM COLOUR COATED INSTRUMENTS

DE-1491
#3
Extra-Flex

DE-1492
Mini 1

DE-1493
Micro-Mini

DE-1494
Medium
Placing/
Condensing

DE-1495
Large
Placing/
Condensing

DE-1496
0T
Tanner

DE-1497
3
Hollenback

DE-1498
5A

DE-1499
Small/Medium
Contact
Forming

DE-1500
Medium/Large
Contact
Forming

- Инструменты для имплантологии
- Instrumente für Implantologie
- Implantsologie
- زراعة الأسنان

SINUS LIFT INSTRUMENTS HOLLOW HANDLE 9.5MM LENGTH 170MM



DE-1501
Sinus Lift Elevator

DE-1502
Sinus Lift Elevator

DE-1503
Sinus Lift Elevator

DE-1504
Sinus Lift Elevator

DE-1505
Sinus Lift Elevator



- Инструменты для имплантологии
- Implantologie
- Implantologie
- Инструменти для імплантології
- Implantologia
- زراعة الأسنان

SINUS LIFT INSTRUMENTS HOLLOW HANDLE 9.5MM LENGTH 170MM



DE-1506
Sinus Lift Elevator

DE-1507
Sinus Lift Elevator

DE-1508
Sinus Lift Elevator

DE-1509
Sinus Lift Elevator



- Инструменты для имплантологии
- Implantologie
- Implantologie
- Інструменти для імплантології
- Implantologia
- زراعة الأسنان

IMPLANT SINUS LIFT INSTRUMENTS HOLLOW HANDLE 9.5MM LENGTH 170MM



DE-1510
Acute 6577

DE-1511
Sinus1

DE-1512
Sinus2

DE-1513
Sinus3,
Obtuse 6578

DE-1514
Sinus4

DE-1515
Sinus5

DE-1516
Sinus6

DE-1517
Sinus7

- Инструменты для имплантологии
 - Implantologie
 - Implantologie
- Інструменти для імплантології
 - Implantologia
 - زراعة الأسنان

SINUS LIFT INSTRUMENTS HOLLOW HANDLE 9.5MM LENGTH 170MM



DE-1518
Sinuslift 1

DE-1519
Sinuslift 2

DE-1520
Sinuslift 3

DE-1521
Sinuslift 4

DE-1522
Sinuslift 5

DE-1523
Sinuslift 6

DE-1524
Membrane
3Positioning 1

DE-1525
Condenser 1



- Инструменты для имплантологии
- Implantologie
- Implantologie
- Інструменти для імплантології
- Implantoloia
- زراعة الأسنان

Sinus Lift Instrument,
Flexible Sinus Lift instruments
reduce the risk of perforation of the
"Schneider's membrane"



DE-1526
Fig. 1

DE-1527
Fig. 2

DE-1528
Fig. 3

Sinus Lift Elevator,
10 mm Straight grip
Length 175 mm, Sinus lift elevators, dull,
for gentle peeling and lifting the
Schneider membrane



DE-1529
Fig. 1

DE-1530
Fig. 2

DE-1531
Fig. 3

Sinus lift instrument
10 mm Straight grip Length 180 mm,
Buser (B1, B2, B3) raspatories,
quality medical stainless steel,
corrosion-resistant



DE-1532
B01

DE-1533
B02

DE-1534
B03



- Инструменты для имплантологии
 - Implantologie
 - Implantologie
- Інструменти для імплантології
 - Implantologia
 - زراعة الأسنان

Sinus lift instrument 10 mm Straight grip Sinus lift elevators, blunt or sharply curved
 (H01, H02, K03, K04, K78, K77)



DE-1535
 Sinus lift
 instrument
 H01

DE-1536
 Sinus lift
 instrument
 H02

DE-1537
 Sinus lift
 instrument
 K03

DE-1538
 Sinus lift
 instrument
 K04

DE-1539
 Sinus lift
 instrument
 K78

DE-1540
 Sinus lift
 instrument
 K77

- Инструменты для имплантологии
- Instrumente für Implantologie
- Имплантологія
- Implantschirurgie
- زراعة الأسنان

SINUS LIFT INSTRUMENT

Sinus Lift Elevators, 10 mm Hollow Handle length 170mm Blunt Curved Set of 6 Pcs



- Инструменты для имплантологии
- Implantologie
- Implantologie

- Інструменти для імплантології
- Implantologia
- زراعة الأسنان

IMPLANT SINUS LIFT INSTRUMENTS
 PERIODONTAL SURGERY SURGICAL CHISELS
 KRAMER NEVINS SINUS LIFT

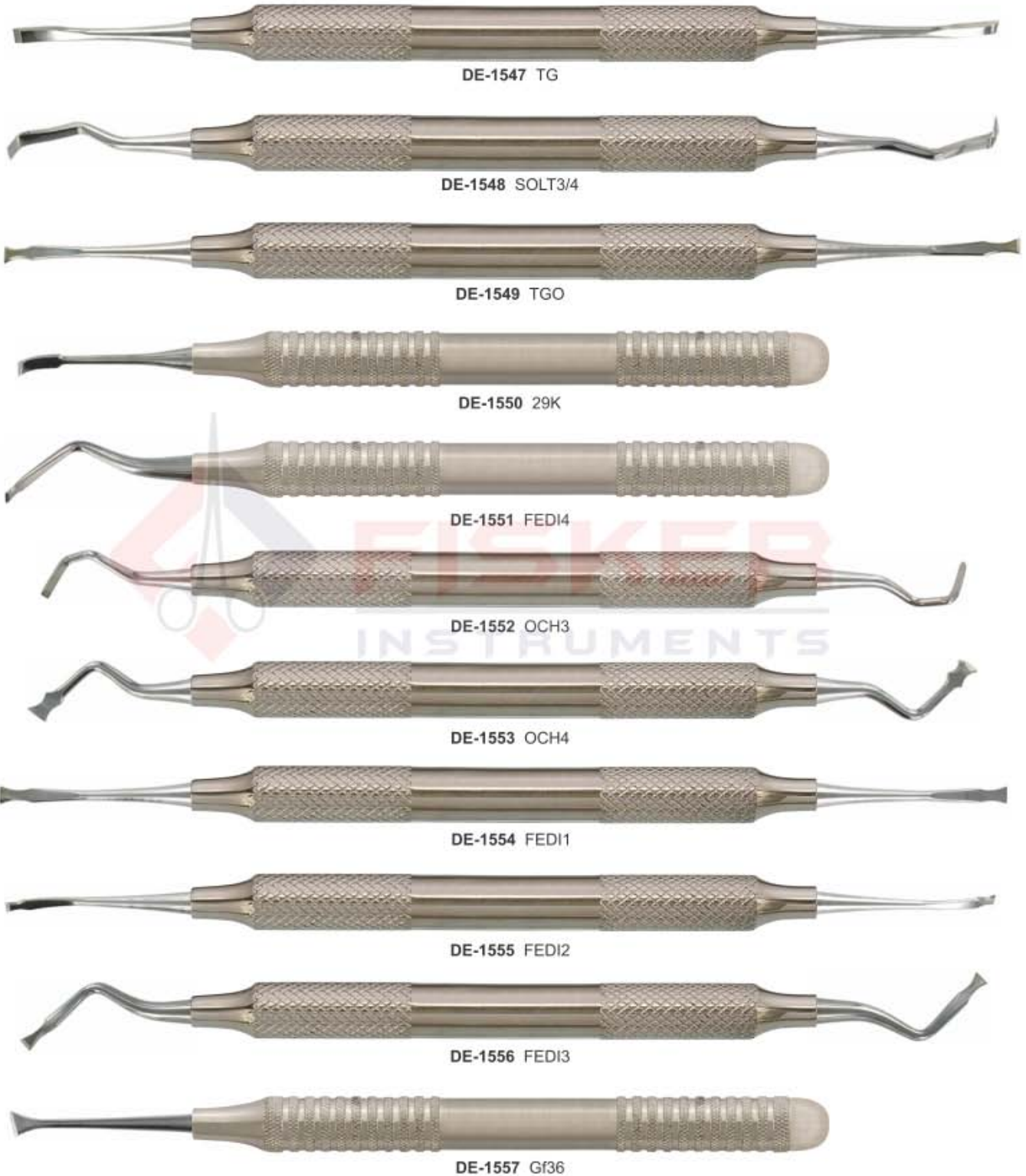

DE-1547 TG

DE-1548 SOLT3/4

DE-1549 TGO

DE-1550 29K

DE-1551 FEDI4

DE-1552 OCH3

DE-1553 OCH4

DE-1554 FEDI1

DE-1555 FEDI2

DE-1556 FEDI3

DE-1557 Gf36



- Инструменты для имплантологии
- Implantologie
- Implantologie
- Інструменти для імплантології
- Implantoloia
- زراعة الأسنان

IMPLANT

SURGICAL CHISELS



- Инструменты для имплантологии
- Implantologie
- Implantologie

- Інструменти для імплантології
- Implantologia
- زراعة الأسنان

MIXING SPATULA WITH SHOVEL

DE-1568
 Bone Carrier
 Titanium



DE-1569
 Raspator, Prichard
 Length 180 mm,
 10 mm hollow handle,
 double-ended
 10.5 mm | 4.5 mm,



DE-1570
 Raspator, Prichard
 Length 180 mm,
 10 mm hollow handle,
 double ended



DE-1571
 Raspator, Prichard
 Length 180 mm,
 10 mm hollow handle,
 double-ended
 10.5 mm | 4.5 mm,



DE-1572
 Mixing Spatula
 with shovel
 17cm



DE-1573
 Mixing Spatula
 with shovel
 18.5cm

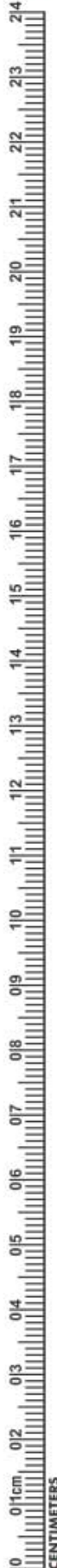

- Инструменты для имплантологии
- Implantologie
- Implantologie
- Інструменти для імплантології
- Implantoloia
- زراعة الأسنان

BONE GRAFTING INSTRUMENTS COMPACTOR /TAMPERS

Product offering includes instruments for harvesting, mixing and compacting bone Provides clinicians with the proper instrumentation for bone grafting procedures Weighted bone basin Prevents tipping and spilling of bone and other materials during mixing



DE-1574
Graft Packer,
Concave Tips
DE 4/6mm

DE-1575
Bone Spoon/
Packer DE 3mm

DE-1576
Graft Packer,
Serrated Tips
DE 6/8mm

DE-1577
Graft Packer,
Serrated Tips
DE 3/4mm

DE-1578
Graft Packer,
Smooth Tips
DE 5/8mm

DE-1579
Titanium graft packer/
placement site depth
gauge 3.3mm & 4.0mm
Diameter tips Marked
at 8, 11, 13, 15 & 18mm

DE-1580
Graft Material Spoon
Concave Tip For
Larger Grafts

- Инструменты для имплантологии
- Implantologie
- Implantologie

- Інструменти для імплантології
- Implantologia
- زراعة الأسنان

BONE GRAFTING INSTRUMENTS

DE-1581
Blade and pusher
 Length 180 mm,
 for straight or angled,
 blade: 15 x 5 mm,
 pusher: 4 mm diameter
 Straight



DE-1582
Blade and pusher
 Length 180 mm,
 for straight or angled,
 blade: 15 x 5 mm,
 pusher: 4 mm diameter
 angular



DE-1583
Spoon and pusher
 Length 180 mm,
 for angled spoon:
 10 x 5 mm, pusher:
 diameter 3 mm



DE-1584
Tunnelierungs
Instrument
 length 175 mm,



DE-1585
Tunnelierungs
Instrument
 length 175 mm,
 different designs



DE-1586
Tamper
 Length 170 mm,
 for bone material,
 double-ended,
 diameter 3.2 mm
 (2-4-6-8-10) and diameter
 2.5mm (2-4-6-8-10)



- Инструменты для имплантологии
- Implantologie
- Implantologie
- Інструменти для імплантології
- Implantologia
- زراعة الأسنان

Pluggers Clarizio

Length 160 mm, with titanium tips for mixing and pouring of autologous, heterologous bone substitute material, diameter (3/4 or 6/8 mm)

BONE GRAFTING INSTRUMENTS



DE-1587 Ø 4mm
DE-1588 Ø 5mm
Compactor
150mm



DE-1589
Sinus Window
Bone Tampers
4 mm



DE-1590
Sinus Window
Bone Tampers
7 mm



DE-1591
6/8mm



DE-1592
3/4mm



- Инструменты для имплантологии
 - Implantologie
 - Implantologie
- Інструменти для імплантології
 - Implantologia
 - زراعة الأسنان

SPOON AND PUSHER (TRINOVO)

Trinovo handle, different workers, for bone material, high-grade medical stainless steel, corrosion-resistant

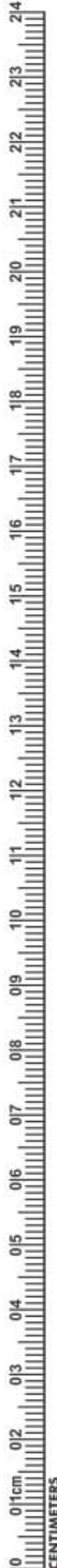

DE-1593
10x5mm

Spoon and Pusher
with safety stop

DE-1594
10x5mm

Spoon and Pusher
with safety stop

DE-1595
10x5mm

Spoon and Pusher
with safety stop

DE-1596
Bone Graft/Carrier
Titanium
2-4-6-8-10mm

DE-1597
15x10mm

Spoon and Pusher
with safety stop

DE-1598
10x5mm

Spoon and Pusher
with safety stop

DE-1599
10x5mm

Spoon and Pusher
with safety stop

- Инструменты для имплантологии
- Implantologie
- Implantologie
- Інструменти для імплантології
- Implantologia
- زراعة الأسنان

PERIOSTEALS ELEVATOR 10mm Hollow Handle



DE-1600
Raspator,
BonexScraper
Length 165 mm,
10 mm hollow
handle,
double-ended 6
mm / 4 mm,

DE-1601
Raspator,
Raspatory
Length 180 mm,
10 mm hollow
handle,
double-ended
3 mm | 3 mm,

DE-1602
Raspator,
Raspatory
Length 180 mm,
10 mm hollow
handle,
double-ended
3 mm | 3 mm,

DE-1603
Raspator,
Papilla
Length 185 mm,
10 mm hollow
handle,
double-ended
3 mm | 2 mm,

DE-1604
Raspator,
bone scraper
Length 175 mm,
10 mm hollow
handle,
double-ended,

DE-1605
Raspator,
micro-Freer
Length 180 mm,
6 mm solid grip,
double-ended
3 mm | 4 mm

DE-1606
Raspator,
Freer
Length 180 mm,
6 mm solid
handle,
double-ended
5 mm | 5 mm,

- Инструменты для имплантологии
- Implantologie
- Implantologie
- Инструменти для імплантології
- Implantologia
- زراعة الأسنان

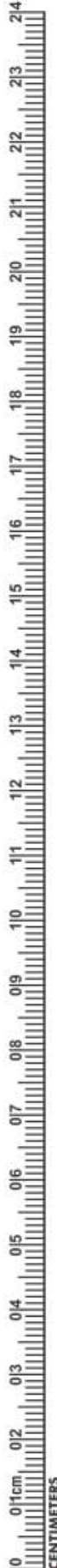
PERIOSTEALS ELEVATOR 10mm Hollow Handle

DE-1607
 Raspator,
 Freer
 10 mm hollow
 handle,
 high-quality
 medical
 double ended

DE-1608
 Raspator,
 Molt
 Length 180 mm,
 8 mm solid
 grip,
 double-ended
 6 mm

DE-1609
 Raspator,
 micro Freer
 Length 185 mm,
 10 mm hollow
 handle,
 double-ended,

DE-1610
 Raspator,
 micro Freer
 Length 185 mm,
 10 mm hollow
 handle,
 double-ended,

DE-1611
 Raspator, micro
 Raspator /
 chisel
 Length 170 mm,
 10 mm hollow
 handle,
 double-ended,

DE-1612
 Raspator, micro
 Raspator /
 chisel
 Length 175 mm,
 10 mm hollow
 handle,
 double-ended,

DE-1613
 Raspator,
 Micro Raspator /
 chisel
 Length 175 mm,
 8 mm solid handle,
 double-ended
 3.5mm | 3.5 mm,

- Инструменты для имплантологии
- Implantologie
- Implantologie
- Інструменти для імплантології
- Implantoloia
- زراعة الأسنان

PERIOSTEALS ELEVATOR 10mm Hollow Handle



DE-1614
Raspatory Micro Molt
Length 175 mm,
corrosion-resistant

DE-1615
Raspatory Chipping
Workers:
Chisel 24G and 7.5 mm,
length about 175 mm,
corrosion-resistant

DE-1616
Raspatory MOLT
Work ends:
5.0 mm and 4.0 mm,
length about 175 mm,
corrosion-resistant

DE-1617
Rasp, Molt M9
Length 175 mm,
corrosion-resistant

DE-1618
Raspator, WAUTIER
Length 175 mm,
corrosion-resistant

DE-1619
Raspator, BENQUE
Length 170 mm,
workers
5 mm | 7 mm,
corrosion-resistant

DE-1620
Raspator, Nordberg
Length 180 mm,
8 mm hollow handle,
double-ended
6 mm | 4 mm

- Инструменты для имплантологии
- Implantologie
- Implantologia

- Інструменти для імплантології
- Implantologia
- زراعة الأسنان

Hollow Handle 10mm Length 170mm

- Инструменты для имплантологии
- Implantologie
- Implantologie
- Инструменти для імплантології
- Implantoloia
- زراعة الأسنان

TISSUE MEMBRANE FORCEPS



DE-1630
Tissue Graft Forcep
Serrated Teeth



DE-1631
Self Locking
Grooved



DE-1632
Tissue Graft Forcep
Serrated Teeth



DE-1633
Titanium
Locking Plier



DE-1634
TC Gripper Carbide
Tipped Tissue Forceps
Serrated Carbide Tips
14.5cm



DE-1635
Adson Carbide
Tipped Tissue Forceps
Serrated Carbide Tips
12cm



DE-1636
Micor Adson 1x2
Tissue Forcep 12.1cm
1x2 Teeth - 0.5mm Tips



DE-1637
Adson 7x7
Tissue Forceps
7x7 Teeth 12cm



DE-1638
Adson 7x7 Curved
Tissue Forceps
7x7 Teeth 12cm



DE-1639
Suture Pliers
Suture Forceps with
1.6mm Ring Tip



DE-1640
Debakey Atraumatic
Tissue Forceps Straight
Serrated Teeth
16cm



DE-1641
Debakey Atraumatic
Tissue Forceps Curved
Serrated Teeth
16cm



- Инструменты для имплантологии
- Implantologie
- Implantologie
- Инструменти для имплантології
- Implantologia
- زراعة الأسنان

TISSUE MEMBRANE FORCEPS

DE-1642
 Russian Long
 Tissue Forceps
 Serrated Tip
 20cm



DE-1643
 Russian
 Tissue Forceps
 Serrated Tip
 15cm



DE-1644
 Tissue Punch Forceps
 To Remove Tissue
 After Using Punch



DE-1645
 13.5 cm
 narrow



DE-1646
 10.5 cm

Membrane tweezers KUEHNE



DE-1647
 13.5 cm
 wide



DE-1648
Pin-Tweezers
 with or without lock,
 length 15 cm,
 with lock



DE-1649
 without lock,



DE-1650
Haltepinzette with lock
 15,5 cm, for pins, towards
 the tips, etc.,



DE-1651
 Carry Forceps
 15cm



DE-1652
 Carry Forceps
 15cm



DE-1653
 Carry Forceps
 15cm



- Инструменты для имплантологии
- Implantologie
- Implantologie
- Инструменти для імплантології
- Implantologia
- زراعة الأسنان

OSTEOTOME CONVEXES / CONCAVE / CONIQUES

CONVEXES



DE-1654
SET OF 5 PIECES

CONCAVES



DE-1655
SET OF 5 PIECES

CONIQUES



DE-1656
SET OF 5 PIECES

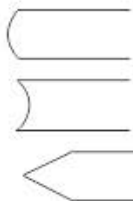
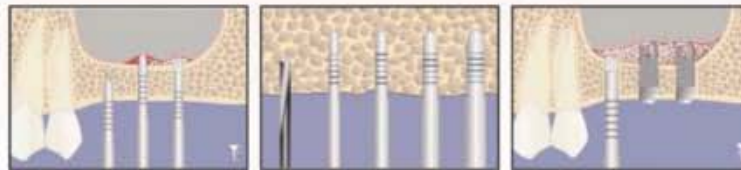

CONVEXES STRAIGHT	DE-1654	2,7 Ømm	3,2 Ømm	3,7 Ømm	4,2 Ømm	5 Ømm
CONCAVES STRAIGHT	DE-1655	2,7 Ømm	3,2 Ømm	3,7 Ømm	4,2 Ømm	5 Ømm
CONIQUES STRAIGHT	DE-1656	2,7 Ømm	3,2 Ømm	3,7 Ømm	4,2 Ømm	5 Ømm



- Инструменты для имплантологии
- Implantologie
- Implantsologie
- Инструменти для імплантології
- Implantologia
- زراعة الأسنان

OSTEOTOME CONVEXES / CONCAVE / CONIQUES

CONVEXES



DE-1657
SET OF 5 PIECES

CONCAVES



DE-1658
SET OF 5 PIECES

CONIQUES



DE-1659
SET OF 5 PIECES

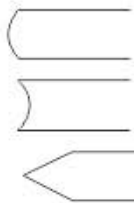
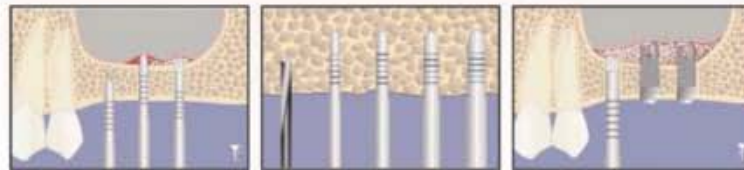

CONVEXES CURVED	DE-1657	2,7 Ømm	3,2 Ømm	3,7 Ømm	4,2 Ømm	5 Ømm
CONCAVES CURVED	DE-1658	2,7 Ømm	3,2 Ømm	3,7 Ømm	4,2 Ømm	5 Ømm
CONIQUES CURVED	DE-1659	2,7 Ømm	3,2 Ømm	3,7 Ømm	4,2 Ømm	5 Ømm

- Инструменты для имплантологии
 - Implantologie
 - Implantologie
- Інструменти для імплантології
 - Implantologia
 - زراعة الأسنان

TREPHINE

Burs with depth markings are suited for precise and simple transplantation of cylindrical bone grafts as well as for all other bone-extraction tasks.



Ø4.0 Ø5.0 Ø6.0 Ø7.0



DE-1669
Tissue Punch with pin
Set of Four Pieces



DE-1670
Tissue Punch
Set of Five Pieces



DE-1671
Tissue Punch
Set of Five Pieces



DE-1672
Trephine Drill
Set of Eight Pieces

FISHER INSTRUMENTS



Ø2.0mm Ø2.5mm Ø2.8mm Ø3.2mm Ø3.65mm Ø4.2mm Ø5.2mm

DE-1673
Short Implant Drills

DE-1674
Long Implant Drills



DE-1675
Trephine Drill
Set of Eight Pieces



- Инструменты для имплантологии
- Implantologie
- Implantologie

- Інструменти для імплантології
- Implantologia
- زراعة الأسنان

BONE SCRAPER STRAIGHT & CURVED

DE-1676
 Bone Scraper
 Straight

DE-1677
 Bone Scraper
 Curved

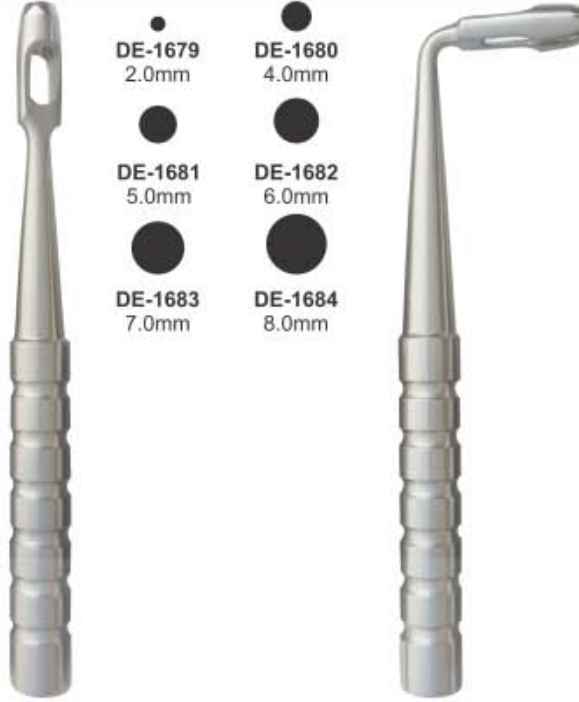
TISSUE PUNCH STRAIGHT & CURVED

DE-1678
 Tissue Punch
 Straight

DE-1685
 Tissue Punch
 Curved

 ●
DE-1679
 2.0mm

 ●
DE-1680
 4.0mm

 ●
DE-1681
 5.0mm

 ●
DE-1682
 6.0mm

 ●
DE-1683
 7.0mm

 ●
DE-1684
 8.0mm

 ●
DE-1686
 2.0mm

 ●
DE-1687
 4.0mm

 ●
DE-1688
 5.0mm

 ●
DE-1689
 6.0mm

 ●
DE-1690
 7.0mm

 ●
DE-1691
 8.0mm

DE-1692
 Bone Mill

DE-1693
 Basins For Bone

BONE CRUSHER
DE-1694

- Инструменты для имплантологии
- Implantologie
- Implantologie
- Інструменти для імплантології
- Implantologia
- زراعة الأسنان

KEYS FOR IMPLANT SCREW



DE-1695



DE-1696



DE-1697



DE-1698

TORQUE WRENCH & RATCHET



DE-1699 Star Torque Wrench 6.35mm Universal



DE-1700 Round Torque Wrench 4.0mm Universal



DE-1701 Hex Driver With 4.0mm Driver



DE-1702 Star Torque Wrench 6.35mm Universal



DE-1703 Hex Torque Wrench 4.00mm Universal



DE-1704 Star Torque Wrench 6.35mm Universal



DE-1705 Star Torque Wrench 6.35mm Universal



DE-1706 Star Torque Wrench 6.35mm Universal



DE-1707 Star Torque Wrench 6.35mm Universal



DE-1708 Star Torque Wrench 6.35mm Universal



DE-1709 Star Ratchet Wrench 6.35mm Universal



DE-1710 Star Ratchet Wrench 6.35mm Universal



DE-1711 Star Ratchet Wrench 6.35mm Universal



DE-1712 Star Ratchet Wrench 4.0mm Universal



DE-1713 Round Ratchet Wrench 4.0mm Universal



DE-1714 Round Ratchet Wrench 3.35mm Universal



DE-1715 Star Ratchet Wrench 4.0mm Universal



DE-1716 Star Ratchet Wrench 6.35mm Universal



- Инструменты для имплантологии
- Implantologie
- Implantologie
- Инструменти для имплантології
- Implantologia
- زراعة الأسنان

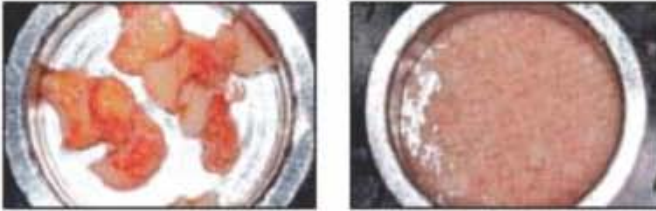

- Инструменты для имплантологии
- Implantologie
- Implantologie
- Инструменти для імплантології
- Implantoloia
- زراعة الأسنان

BONE EXPANDER SCREW & SURGICAL KITS



DE-1722
 Bone Universal Kit
 Drill: 2mm, 2.8mm, 3.2mm, 3.65mm,
 4.2mm, 4.5mm, 4.8mm, 5.2mm
 Trephines Bit:
 3.0mm, 4.0mm, 5.0mm, 6.0mm,
 7.0mm, 8.0mm, 9.0mm, 10mm.
 Driver:
 2.5mm, 2.5mm Hand Pcs
 1.25mm, 1.25mm Hand Pcs
 Short Driver 2.5mm
 Long Driver 2.5mm
 1.25mm, Short Hex Driver Hand Pcs
 1.25mm, Long Hex Driver Hand Pcs
 Torque Wrench 4.0mm



DE-1723
 Bone Expander Kit
 Expander: 2.6mm, 3.0mm,
 3.4mm, 3.8mm, 4.3mm
 Ratchet Driver
 Parallel Pin
 Pilot Drill
 Drill 1.4mm
 Drill Driver 4mm
 Hand Driver 4mm
 Ratchet 4.0mm



DE-1724
 Bone Universal Kit
 Drill: 2mm, 2.8mm, 3.2mm, 3.65mm,
 4.2mm, 4.5mm, 4.8mm, 5.2mm
 Trephines Bit:
 3.0mm, 4.0mm, 5.0mm, 6.0mm,
 7.0mm, 8.0mm, 9.0mm, 10mm.

Bone Compression:
 2mm, 3.3mm, 2.8mm, 4.2mm, 3mm, 3.5mm
 Driver:
 2.5mm, 2.5mm Hand Pcs
 1.25mm, 1.25mm Hand Pcs
 Short Driver 2.5mm
 Long Driver 2.5mm
 1.25mm, Short Hex Driver Hand Pcs
 1.25mm, Long Hex Driver Hand Pcs
 Torque Wrench 6.35mm 1 Pcs

FISKER
INSTRUMENTS



DE-1725
 Conical Drills: 20 Pcs
 Tissue Punches:
 3.0mm, 3.50mm, 4.0mm, 4.5mm,
 5.0mm, 6.0mm, 6.50mm
 Bone Expander:
 1.6/3.8mm, 1.9/3.0mm, 2.1/3.6mm,
 2.6/3.8mm, 2.9/4.3mm
 Drill Adapter: 1 Pcs
 1.25mm, 2.50mm Hex Driver Hand Pcs

Pilot Drill: 1.6mm
 Drill Bit: 1.4mm, 1.6mm, 1.8mm, 2.0mm, 2.2mm
 Ratchet Driver: 4mm/6.35, 1.25/2.50
 Rimer: 3.2/4.7mm, 3.7/4.7mm
 Parallel Pin: 4.5mm, 2.5mm
 Double step Drill: 2.4/2.8mm
 Depth Gauge: 1 Pcs
 Torque Wrench 6.35mm Universal: 1 Pcs



- Инструменты для имплантологии
 - Implantologie
 - Implantologie
- Інструменти для імплантології
 - Implantologia
 - زراعة الأسنان

BONE INJECTORS, COLLECTORS & SUCTION TUBE

DE-1726
 Ø 2,5mm /
 3,5mm
 170mm

DE-1727
 Ø 4,5mm /
 5,5mm
 170mm

DE-1728
 Ø 3,5mm /
 4,5mm
 170mm

DE-1729
 Ø 6,0mm /
 7,0mm
 170mm



DE-1730
 18cm
 Straight / Bend
 I.D 2.5mm
 O.D 3.5

DE-1731
 18cm
 Straight / Bend
 I.D 3.5mm
 O.D 4.5

DE-1732
 18cm
 Straight / Bend
 I.D 4.5mm
 O.D 5.5

DE-1733
 18cm
 Straight / Bend
 I.D 6.0mm
 O.D 7.0



DE-1734
 17.5cm

DE-1735
 18cm

DE-1736
 coarse
 Ø 5mm

Suction tubes
 to collect
 the extracted
 bone material
 180mm

DE-1737
 fine
 Ø 9mm



DE-1738
 Suction
 Tubes
 180mm

DE-1739
 Suction
 Tubes
 180mm

DE-1740
 Suction
 Tubes
 180mm



DE-1742
 Ø 3 mm
 length 180mm
DE-1743
 Ø 4 mm
 length 180mm
DE-1744
 Ø 5 mm
 length 180mm

DE-1741
 Fig. 6FR
 Frazier
 15 cm - Ø 2 mm

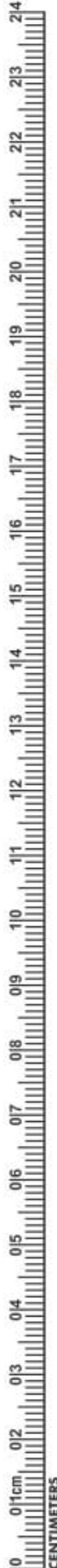

IMPRESSION TRAYS

- Оттисные ложки
- Відбиткові ложки
- Porte-empreinte
- Cubetas para impresiones
- Abdrucklöffel
- صواني الانطباع

PERFORATED WITH RIM LOCK Set of 06 Pcs

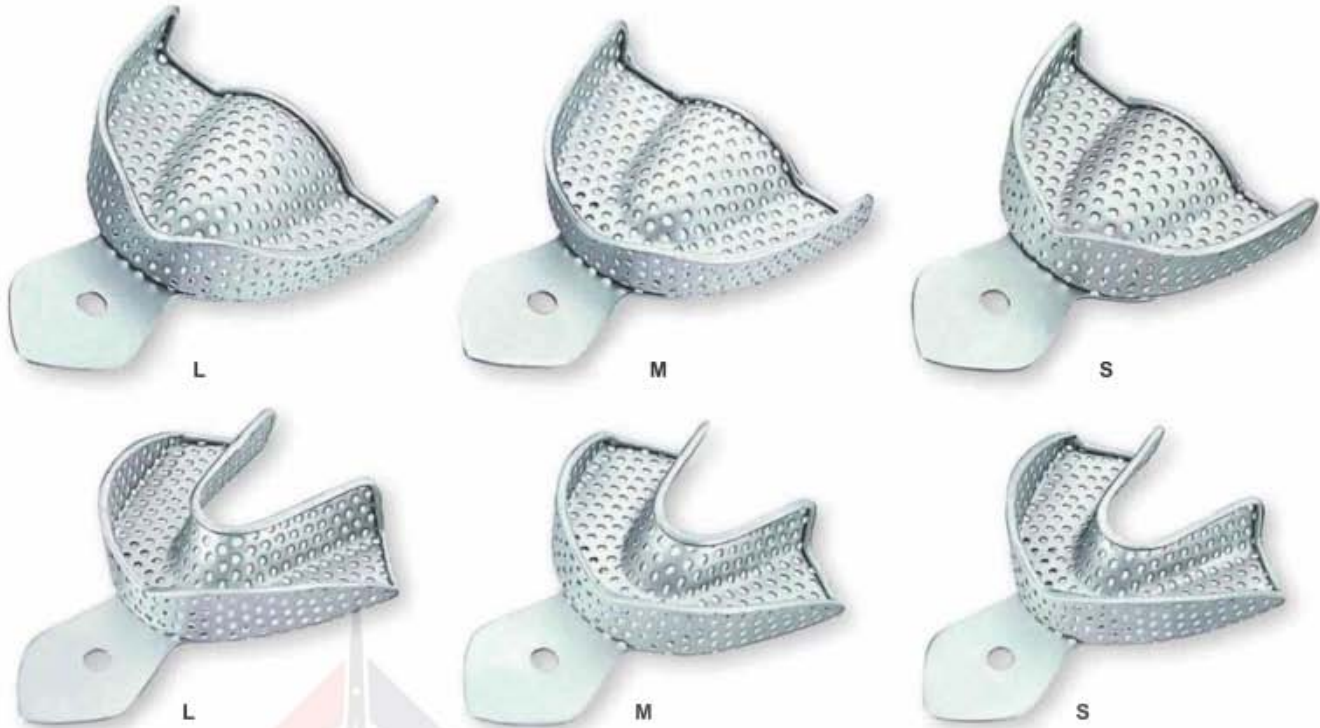

DE-1745 SET OF 06 PCS
Upper: S, M, L
Lower: S, M, L

PERFORATED WITH RIM LOCK Set of 8 Pcs



DE-1746 SET OF 08 PCS
Upper: XS, S, M, L
Lower: XS, S, M, L

DE-1747 SET OF 08 PCS
Upper: S, M, L, XL
Lower: S, M, L, XL

DE-1748 SET OF 10 PCS
Upper: XS, S, M, L, XL
Lower: XS, S, M, L, XL



- Оттисные ложки
- Porte-empreinte
- Abdrucklöffel

- Відбиткові ложки
- Cubetas para impresiones
- صواني الانطباع

SOLID WITH RIM LOCK
Set of 6 Pcs



DE-1749 SET OF 06 PCS
Upper: S, M, L
Lower: S, M, L

SOLID WITH RIM LOCK
Set of 8 Pcs



DE-1750 SET OF 08 PCS
Upper: XS, S, M, L
Lower: XS, S, M, L

DE-1751 SET OF 08 PCS
Upper: S, M, L, XL
Lower: S, M, L, XL

DE-1752 SET OF 10 PCS
Upper: XS, S, M, L, XL
Lower: XS, S, M, L, XL



IMPRESSION TRAYS

- Оттисковые ложки
- Відбиткові ложки
- Porte-empreinte
- Cubetas para impresiones
- Abdrucklöffel
- صواني الانطباع

PERFORATED FULL DENTURE Set of 8 Pcs

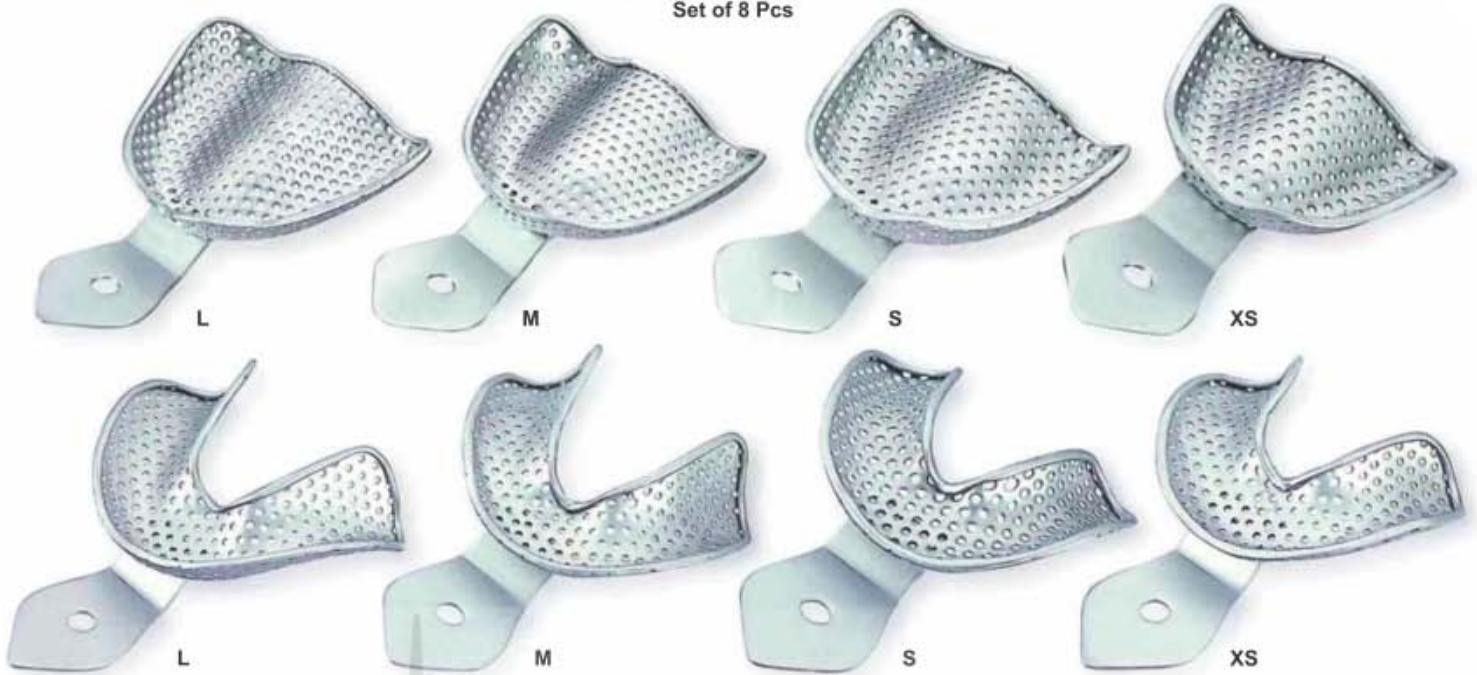

DE-1753 SET OF 08 PCS
Upper: S, M, L, XL
Lower: S, M, L, XL

DE-1754 SET OF 08 PCS
Upper: S, M, L
Lower: S, M, L

SOLID FULL DENTURE Set of 8 Pcs

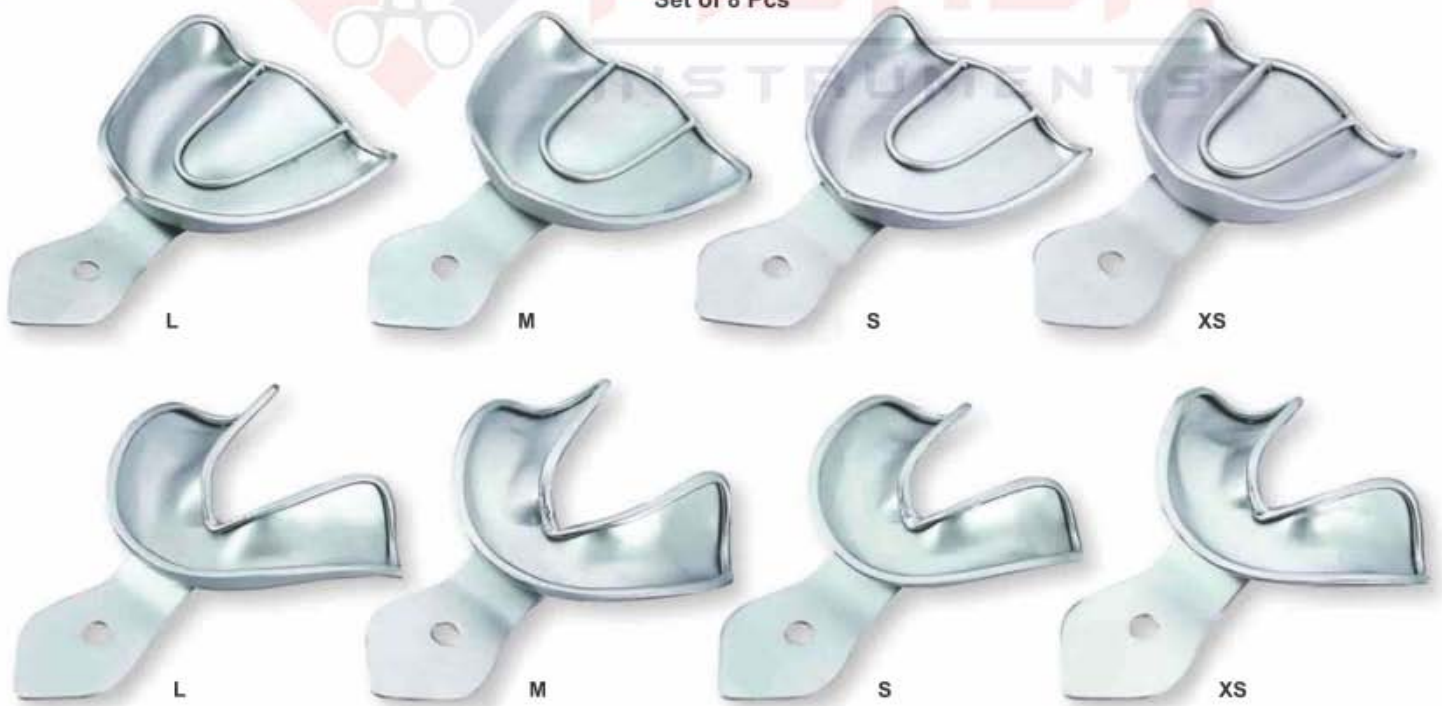

DE-1755 SET OF 08 PCS
Upper: S, M, L, XL
Lower: S, M, L, XL

DE-1756 SET OF 06 PCS
Upper: S, M, L
Lower: S, M, L



- Оттисные ложки
- Porte-empreinte
- Abdrucklöffel

- Відбиткові ложки
- Cubetas para impresiones
- صواني الانطباع

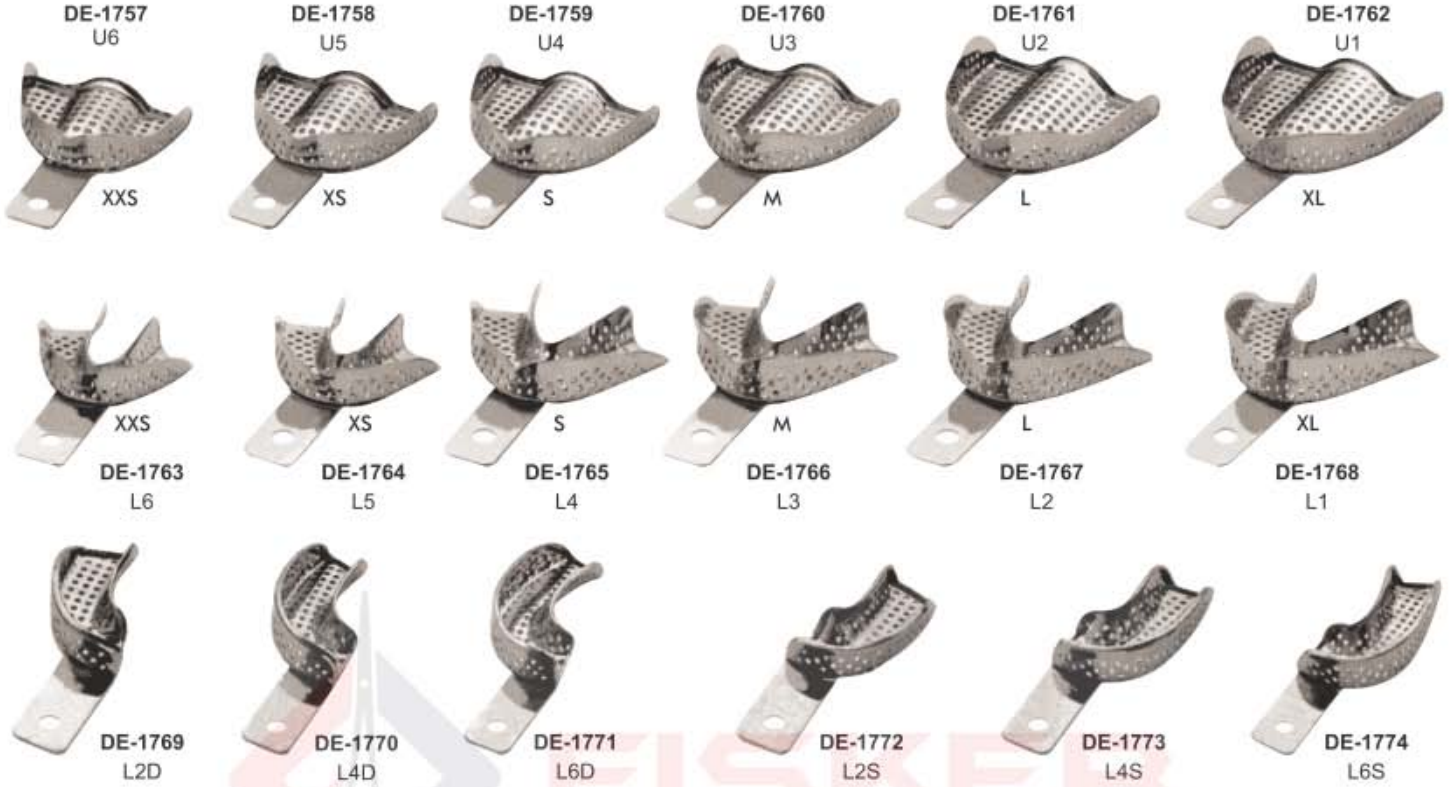
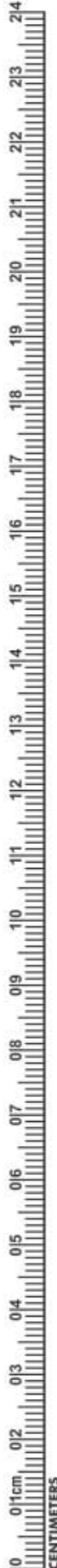
Perforated Without Rim Lock

Solid With Rim Lock

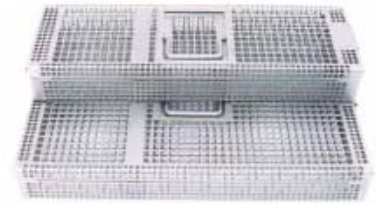

DE-1793
Mesh Cassettes
5 Pieces, 7 Pieces, 10 Pieces,
15 Pieces & 20 Pieces



DE-1795
Instruments Cassette
7 Pieces & 10 Pieces



DE-1796
Gracey Curette Set Cassettes



DE-1797
182 x 150 x 20 mm
10 Instruments



DE-1798
180 x 85 x 15 mm
5 Instruments



DE-1799
288 x 182 x 35 mm
20 Instruments

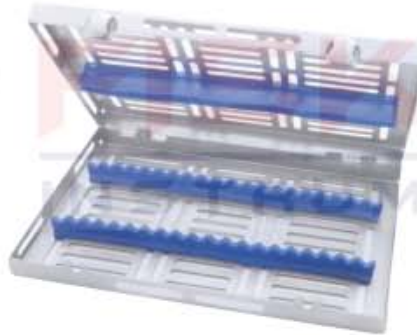

DE-1800
288 x 182 x 35 mm
20 Instruments



DE-1801
182 x 145 x 35 mm
10 Instruments



DE-1802
182 x 72 x 35 mm
5 Instruments

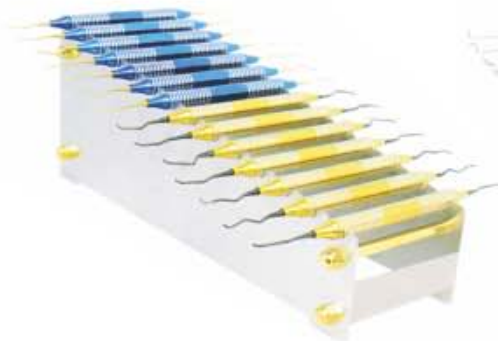

DE-1804
Gracey Curette Set Stand



DE-1803
182 x 145 x 35 mm
9 Instruments

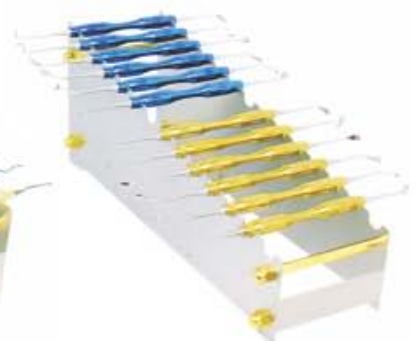

DE-1805
Sinus Lift Set Stand



Made of 18/8 stainless steel

KIDNEY TRAY WITH COVER
 (English Pattern)

DE-1806	Size
DE-1807	150 mm
DE-1808	200 mm
DE-1809	240 mm
	300 mm

Kidney Trays

With lid available		Without lid available	
DE-1810	6"	DE-1814	6"
DE-1811	8"	DE-1815	8"
DE-1812	10"	DE-1816	10"
DE-1813	12"	DE-1817	12"



Deep	DE-1818	2.25" - 2"
	DE-1819	4.75" - 2"
	DE-1820	5.5" - 2.5"
	DE-1821	6.25" - 2.75"
	DE-1822	7" - 3.5"

Sterilizing Drum

Art #	mm	h mm
DE-1823	80	80
DE-1824	120	120
DE-1825	160	120
DE-1826	190	140
DE-1827	190	200
DE-1828	240	120
DE-1829	240	160
DE-1830	240	240
DE-1831	290	120
DE-1832	290	160
DE-1833	290	240
DE-1834	340	160
DE-1835	340	240
DE-1836	390	145
DE-1837	390	200
DE-1838	390	290

Bowl
 DE-1839 Fig. 1 to 14

DE-1840
 Endodontic Box

DE-1841 6" x 8"
DE-1842 8" x 10"
DE-1843 10" x 12"
 Without Lid

DE-1844
 Instruments Box

SCALER TRAY
DE-1845
 100 x 200 mm

Sterilizing Cases
Stainless Steel



- DE-1846 130X50X50 mm
- DE-1847 130X60X50 mm
- DE-1848 140X80X50 mm
- DE-1849 150X60X50 mm
- DE-1850 160X30X25 mm
- DE-1851 170X70X30 mm
- DE-1852 180X80X40 mm
- DE-1853 180X90X40 mm
- DE-1854 200X100X40 mm

- DE-1855 220X120X50 mm
- DE-1856 230X130X50 mm
- DE-1857 230X150X50 mm
- DE-1858 250X100X50 mm
- DE-1859 300X150X50 mm
- DE-1860 300X200X50 mm
- DE-1861 350X160X60 mm
- DE-1862 400X200X90 mm
- DE-1863 500X200X125 mm

- DE-1864 130X50X50 mm
- DE-1865 130X60X50 mm
- DE-1866 140X80X50 mm
- DE-1867 150X60X50 mm
- DE-1868 160X30X25 mm
- DE-1869 170X70X30 mm
- DE-1870 180X80X40 mm
- DE-1871 180X90X40 mm
- DE-1872 200X100X40 mm

- DE-1873 220X120X50 mm
- DE-1874 230X130X50 mm
- DE-1875 230X150X50 mm
- DE-1876 250X100X50 mm
- DE-1877 300X150X50 mm
- DE-1878 300X200X50 mm
- DE-1879 350X160X60 mm
- DE-1880 400X200X90 mm
- DE-1881 500X200X125 mm



INSTRUMENTS BOX

- DE-1882 130/50/50 mm
- DE-1883 130/60/50 mm
- DE-1884 140/80/50 mm
- DE-1885 150/60/50 mm
- DE-1886 160/30/25 mm
- DE-1887 170/70/30 mm
- DE-1888 180/80/40 mm
- DE-1889 180/90/40 mm
- DE-1890 200/100/40 mm
- DE-1891 220/120/50 mm

- DE-1892 230/130/50 mm
- DE-1893 230/150/50 mm
- DE-1894 250/150/50 mm
- DE-1895 300/150/50 mm
- DE-1896 300/200/50 mm
- DE-1897 350/160/60 mm
- DE-1898 350/160/60 mm
- DE-1899 400/200/90 mm
- DE-1900 500/200/125mm



NEEDLES BOX

- DE-1901 150/60/20 mm
- DE-1902 140/80/20 mm
- DE-1903 220/120/20 mm



- FORCEPS JAR**
DE-1904 Fig. 1 to 5
- | Ø | h |
|----|-----|
| mm | mm |
| 52 | 100 |
| 52 | 130 |
| 52 | 175 |
| 70 | 130 |
| | 175 |
| | 200 |
| | 200 |



- Forceps Jars**
DE-1905 Fig. 3/3
- | Ø | h |
|----|-----|
| mm | mm |
| 25 | 130 |



- Forceps Jar**
- DE-1906 25 x 80mm
 - DE-1907 30 x 100mm
 - DE-1908 100 x 200mm
 - DE-1909 75 x 173mm





Mm Hmm
55 70
Cotton Holders
DE-1910 Fig. 000/1



Cotton Holder -
DE-1911



DE-1912
Sprit Lamp
Single Nut



DE-1913
Sprit Lamp



DE-1914
Endodontic Box
Small & Large



DE-1915
Needle Case Round with Cover



DE-1916
Bedpan Perfection Type
Small & Large



DE-1917
Urinal Female, Urinal Male, Urinal Male Vertical



IMPLANTOLOGY

- Инструменты для имплантологии
- Implantologie
- Implantologie
- Інструменти для імплантології
- Implantoloia
- زراعة الأسنان



DE-1918
Endo Finger Ruler
Span Measure Scale



DE-1919
Endo Finger Ruler
Span Measure Scale



DE-1920
Endo Finger Ruler
Span Measure Scale



DE-1921
Amalgam Gun



DE-1922
Brush Stainless Steel



DE-1923
Suction Cannula Kit
with 3 Needles



DE-1924
Suction Pipe



DE-1925
Suction Needle
1mm



DE-1926
Suction Needle
1.5mm



DE-1927
Suction Needle
2mm



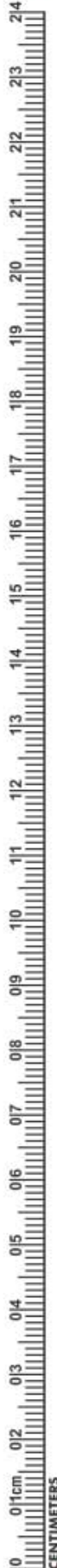

DESCRIPTION	PAGE #	DESCRIPTION	PAGE #	DESCRIPTION	PAGE #
3 PRONG CLASP ADJUSTABLE PLIER TC	107	BEDPAN PERFECTION TYPE SMALL & LARGE	150	EXPLORERS INSTRUMENTS	35
ACORN FILLING INSTRUMENTS	52	BRUSH STAINLESS STEEL	151	EXPLORERS	33-45
ADAM PLIER WITH TC	102	COMPOSITE FILLING INSTRUMENTS	74A	EXTRACTING FORCEPS (AMERICAN PATTERN)	10-14
ADAMS PLIER ROUND BOX	100	COMPOSITE FILLING INSTRUMENTS	74B	EXTRACTING FORCEPS (ENGLISH PATTERN)	01-02, 05-07
ADAMS PLIERS FOR BENDING WIRE	100	COMPOSITE FILLING INSTRUMENTS	74C	EXTRA-FLEX IMPLANTOLOGY INSTRUMENTS	114
ADAMS, SMALL WIRE BENDING AND LOOP FORMING PLIERS	99	COMPOSITE FILLING INSTRUMENTS	74C	ENDODONTIC BOX SMALL & LARGE	150
ADERER FACEBOW LOOP FORMING PLIERS	101	COMPASSO DE WILLIS	96	ENDO FINGER RULER SPAN MEASURE SCALE	96
ADERER LARGE WIRE BENDING AND LOOP FORMING PLIERS	100	COTTON HOLDERS	150	ENDO FINGER RULER SPAN MEASURE SCALE	151
ADERER PLIER	101	CARRY FORCEPS	134	FORCEPS JAR	149
AMALGAM GUN	151	CARVER HOLLENBACK AMALGAM CARVERS	56	FALCON BEAK CONTOURING PLIERS	100
ARROW CLASP FORMING PLIERS	106	CARVERS FILLING INSTRUMENTS	69	FARABEUF RETRACTOR	82
ADSON BROWN TWEEZERS	32	CARVERS INSTRUMENTS	73	FELDMAN RETRACTOR	82
ADSON CARBIDE TIPPED TISSUE FORCEPS	133	CARVERS	71	FILES FILLING INSTRUMENTS	53
ADSON NEEDLE HOLDERS	86	CASTROVIEJO NEEDLE HOLDERS	86	FILLING INS PERIODONTAL INSTRUMENTS	37, 44, 49-55, 69, 72
ADSON TWEEZERS	32	CASTROVIEJO SCISSORS	84	FILLING INSTRUMENTS	37, 44, 49-55, 69, 72
ADSON-TC TWEEZERS	32	CEMENT SPATULAS	75	FLAT NOSE PLIER SMOOTH	105
ALLEN PERIOSTEAL ELEVATORS	95	CHEEK RETRACTOR LONG	80	FLAT NOSE PLIER WITH SERRATION	105
ALLIS 4.5 HAEMOSTATIC FORCEPS	87	CHEEK RETRACTOR	78	FLOHR ROOT ELEVATORS	105
ALLIS-BABY 3/4 HAEMOSTATIC FORCEPS	87	CHEEK RETRACTORS, MINNESOTA	80	FLUCH-CUT DISTAL AND CUTTING PLIERS	100
AMALGAM CARVERS	56-57, 70-71	CHEEK RETRACTORS, RETRACTOR IVORY	80	FOERSTER DRESSING FORCEPS	100
AMALGAM FILES	92	CHEEK RETRACTORS, TONGUE DEPRESSORS	80	FORCEP JAR	148
AMALGAM INSTRUMENTS & SCALPEL HANDLES	71	CHEISEL HOES FILLING INSTRUMENTS	74	FREEDMAN "DUCKHEAD" IMPLANTOLOGY INSTRUMENTS	112
AMALGAM INSTRUMENTS	93	CLAMP OSTEOETER	109	FREEDMAN BURNISHERS IMPLANTOLOGY INSTRUMENTS	112
AMALGAM WELL MATRIX RETAINERS	93	CLAPPISON/FRAMHAM RESTORATIVE INSTRUMENTS	75	FREER PERIOSTEAL ELEVATORS	90
AMALGAM WELL	93	CLAW-LIFT ROOTS ELEVATOR	22	FRIEDMAN BONE ROUNGER	21
ANATOMICAL CARVER	71	COHEN UNIVERSAL FORCEPS	10-11	FRIEDMANN ROOTS ELEVATOR	14
ANDREW RESTORATIVE INSTRUMENTS	70	COLLEGE CURVED	32	GAUGE FOR MEASURING	109
ANGLE FORMERS	72	COLLEGE TWEEZER	32	GERALD TWEEZERS	31
ANGLED DIRECT BOND BRACKET REMOVER TC	106	COLLEGE WITH LOCK TWEEZERS	31	GILLES TWEEZERS	31
ANISWORTH CLAMPS FORCEPS	88	COLLINS TONGUE FORCEPS	31	GILLIES NEEDLE HOLDER WITH SCISSORS	31
ANTERIOR FILLING INSTRUMENTS	68	COMPOSITE/PLASTIC FILLING INSTRUMENTS	49-50, 54	GOLDMAN FOX EXPLORERS	36
ANTERIOR	47	CONDENSER INSTRUMENTS	118	GOLDMAN FOX MERRIT B EXPLORERS	36
APEX ROOT ELEVATORS	15-19	CONDENSER MORTONSON FILLING INSTRUMENTS	50	GOLDMAN FOX UNIVERSITY OF MICHIGAN EXPLORERS	36
APICAL ROOT ELEVATORS	19	CONTOURING INSTRUMENT IMPLANTOLOGY INSTRUMENTS	111	GOLDMAN FOX WILLIAMS EXPLORERS	36
ARCH FORMING PLIERS	104	CONTOURING PLIER	101	GOLDMAN PERIODONTAL INSTRUMENTS	36
ARTICULATORS	77	COSMETIC CONTOURING	113	GOLDMAN-FOX PERIOSTEAL ELEVATORS	95
A-TRAUMATIC EXTRACTION SET	03	COTTON HOLDER	148	GOLDMAN-FOX SCISSORS	83-84
ATRAUMATIC TWEEZERS	31	COUPLAND ROOT ELEVATORS	17	GOLDMAN-FOX SET	61
BACK ACTION FILLING INSTRUMENTS	52	COUPLAND ROOT ELEVATORS	18	GOLDSTEIN INTERPROXIMAL EXCAVATOR	81
BACKHAUS HAEMOSTATIC FORCEPS	87	CRANE KAPLAN TWEEZERS	32	GRACEY AFTER FIVE	42
BACOLITE HANDLE WAX KNIVES	76	CRANE-KAPLAN PERIODONTAL INSTRUMENTS	59	GRACEY CURETTE INSTRUMENTS	62
BALDWIN FILLING INSTRUMENTS	49	CRILE NEEDLE HOLDERS	85	GRACEY CURETTE SET CASSETTES	147
BALL FILLING INSTRUMENTS	52	CRILE-WOOD NEEDLE HOLDERS	85-86	GRACEY CURETTE	43
BALL HOOK CRIMPING PLIER	105	CROWN AND BAND CONTOURING PLIERS	105	GRACEY MINI FIVE	42
BAND PUSHER	90	CROWN REMOVER	90	GRACEY PERIODONTAL INSTRUMENTS	39
BAND REMOVING PLIER	99	CROWN SPREADERS	90	GRACEY SET OF 7 PCS	40-41
BAND SEATER AUTO CLEAVABLE	87	CRAYER EXTRACTING FORCEPS	10	GRAFT PACKER, CONCAVE TIPS	125
BAND SEATING PLIER	104	CRAYER ROOTS ELEVATOR	23	GREGG IMPLANTOLOGY INSTRUMENTS	111
BANDS & CROWNS PLIER	101	CURETTE COLUMBIA	43	GRITMAN CEMENT SPATULAS	75
BASINS FOR BONE	138	CURETTE INSTRUMENTS	63	GROSS MAIER DRESSING FORCEPS	63
BAUMGARTNER NEEDLE HOLDERS	85	CURETTE MCCALL	43	GUM SCISSORS	87
BAUMGARTNER NEEDLE HOLDERS	86	CURETTE	60	HAEMOSTATIC FORCEPS & TOWEL CLAMPS	87
BAYONET ROOTS ELEVATOR SET	21	CURETTES SET OF 8 PIECES	43	HALSEY NEEDLE HOLDERS	85-86
BEAVERTAIL FILLING INSTRUMENTS	85	CURETTES	40-43, 61-62	HALSTEAD MOSQUITO HAEMOSTATIC FORCEPS	87
BEEBEE NEEDLE HOLDERS	52	CUTTING INS PERIODONTAL INSTRUMENTS	39	HALSTEAD MOSQUITO NEEDLE HOLDERS	86
BEIN ROOT ELEVATORS	15-16, 24	DARBY-PERRY EXCAVATORS	65	HALTEPINZETTE WITH LOCK	134
BEYER BONE ROUNGER	14	DE LA ROSA PLIERS WITH GROOVED	165	HAMMER HEAD TIE BACK PLIER	104
BINANGLE FILLING INSTRUMENTS	74	DE LA ROSA PLIERS	105	HANDLES FOR MOUTH MIRRORS	30
BIRD BEAK ANGLED BENDING PLIER	103	DEAN SCISSORS	84	HARD WIRE CUTTERS	107
BIRD BEAK PLIER WITH TC	102	DEBAKEY ATRAUMATIC TISSUE FORCEPS	133	HARRIS EXTRACTING FORCEPS	11
BIRD BEAK WIRE BENDING & CUTTING PLIERS	101	DEEP BOWL	148	HARTMANN (BABY MOSQUITO) NEEDLE HOLDERS	86
BIRD BEAK WIRE BENDING PLIER	100	DEEP ROOT PICK FORCEPS (APICAL SET OF 9)	04	HATCHETS FILLING INSTRUMENTS	68
BIRD BEAK WITH CUTTER PLIERS	104	DELICATE NEEDLE HOLDERS	85	HEAT CARRIERS	46
BLACK FILLING INSTRUMENTS	50	DELUXE BRACKET HOLDER TWEEZERS	96	HEBER ROOTS ELEVATOR	24
BLACK TITANIUM COLOUR COATED INSTRUMENTS	110-111	DENHARD CHEEK RETRACTORS	79	HEIDBRINK ROOT ELEVATORS	20-21, 26
BLADE AND PUSHER	126	DENTAL MIRROR PERIODONTAL INSTRUMENTS	39	HEIDMANN PERIODONTAL INSTRUMENTS	39
BLUMENTHAL BONE ROUNGER	14	DENTAL SYRINGES	13	HEMINGWAY CURETTE INSTRUMENTS	63
BOGHOSIAN FILLING INSTRUMENTS	49	DERF NEEDLE HOLDERS	85	HEMINGWAY TWEEZERS	32
BOGHOSIAN IMPLANTOLOGY INSTRUMENTS	111	DERF NEEDLE HOLDERS	86	HOES	71
BOLEY GAUGE	109	DIRECT BOND BRACKET HOLDER TWEEZERS	96	HOLLANBACK PERIODONTAL INSTRUMENTS	39
BONE BRACKET GAUGE	96	DIRECT BONDING BRACKET HOLDERS	96	HOLLANBACK FILLING INSTRUMENTS	50
BONE CARRIER TITANIUM	124	DIRECT BONDING BRACKET REMOVER PLIER TC	106	HOLLANBACK IMPLANTOLOGY INSTRUMENTS	114
BONE CRUSHER	138, 140	DIRECT BRACKET REMOVER TC	107	HOLLANBACK RESTORATIVE INSTRUMENTS	70
BONE EXPANDER SCREW & SURGICAL KITS	141	DISCOID-CLEOID CARVER	71	HOLLOW HANDLE	132
BONE FILES	94	DISTAL END CUTTER REGULAR WITH T.C	102	HOLLOW WARE	148
BONE GRAFT/CARRIER TITANIUM	128	DISTAL END CUTTER, SAFETY HOLD PLIER	102	HOLLOWCHOP CONTOURING PLIERS	106
BONE GRAFTING INSTRUMENTS COMPACTOR /TAMPERS	125	(IDEAL FOR CUTTING WIRE) TC	107	HOOK CRIMPING PLIER ANGLED STRAIGHT TC	107
BONE GRAFTING INSTRUMENTS	126-127	DISTAL END, WIRE CUTTERS & BRACKET REMOVER PLIERS	107	HOOK KNIVES	76
BONE INJECTORS, COLLECTORS & SUCTION TUBE	142	DOUBLE ENDED CEMENT SPATULA	98	HOW PLIER CURVED WITH TC	103
BONE MILL	138	DISTAL CUTTER	106	HOW PLIER CURVED	99, 104
BONE ROUNGER	14	DRESSING TWEEZERS	31-32	HOW PLIER STRAIGHT WITH TC	103
BONE SCRAPER STRAIGHT & CURVED	138	DENTAL SYRINGES ALL TYPES	14H	HOW PLIER STRAIGHT	103
BONE SPOON/ PACKER	125	ELASTIC SEPARATING PLIER	107	HOWARD PERIOSTEAL ELEVATORS	95
BONE THICKNESS GAUGE	109	ELASTOMERIC LIGATURE PLACING FORCEPS	107	HYGIENIST PERIODONTAL INSTRUMENTS	58
BONE UNIVERSAL KIT	141	WITH GROOVE FALCON	107	HYGIENIST-JACQUETTE PERIODONTAL INSTRUMENTS	58
BRACKET REMOVER ANGULATED PLIER	103	ELLIOT MATRIX RETAINERS	91	HYGIENIST-TOWNER PERIODONTAL INSTRUMENTS	58
BRACKET REMOVER PLIER STRAIGHT	103	ENDED CHEEK RETRACTORS	79	HYLIN CEMENT SPATULAS	75
BRACKET REMOVER PLIERS ANGLED WITH T.C	102	ENDODONTIC BOX	148	HYLIN ROOTS ELEVATOR	23
BRACKET REMOVER PLIERS STRAIGHT WITH T.C	102	ENDODONTICS INSTRUMENTS	47	HEIGHT GAUGE MOVABLE	96
BRACKET REMOVING PLIER ROUND BOX	99	ENGLISH PATTERN KLEIN #3 PEDODONTIC UNIVERSAL FORCEPS	08	IMPLANT GAGES	108
BRACKET REMOVING PLIER	99	EXAMINATION KIT SET OF 3 PIECES	34	IMPLANT SINUS LIFT INSTRUMENTS	117, 122
BREWER CLAMPS FORCEPS	88	EXAMINATION SET OF 4 PIECES	34	IMPLANT	123
BURNISHER FILLING INSTRUMENTS	49	EXAVATORS	37	IMPLANTOLOGY IMPLANTOLOGY INSTRUMENTS	112
BURNISHER FILLING INSTRUMENTS	54	EXCAVATOR PERIODONTAL INSTRUMENTS	39	IMPLANTOLOGY INSTRUMENTS	111
BURNISHER UNIVERSITY OF MICHIGAN AMALGAM CARVERS	56	EXCAVATORS INSTRUMENTS SET OF 11 PIECES	57	IMPLANTOLOGY	108-110
BURNISHERS FILLING INSTRUMENTS	52-53	EXCAVATORS INSTRUMENTS	64-67	IMPRESSION TRAYS	143-146
BURNISHERS IMPLANTOLOGY INSTRUMENTS	112	EXCAVATORS	64	INSTRUMENTS BOX	148
BUSER PERIOSTEAL ELEVATORS	95	EXPLORER PERIODONTAL INSTRUMENTS	39	INSTRUMENTS CASSETTES & STANDS	147

DESCRIPTION	PAGE #	DESCRIPTION	PAGE #	DESCRIPTION	PAGE #
INSTRUMENTS BOX	149	NANCE LOOP FORMING PLIERS	99	ROUND NOSE PLIER	104
NEEDLES BOX	149	NANCE PLIER	105	ROUNDED CONE	73
INTERPROXIMAL CARVER IMPLANTOLOGY INSTRUMENTS	111	NARROW MATRIX RETAINERS	91	ROUNDED-CONE FILLING INSTRUMENTS	49
INTERPROXIMAL OFF-ANGLE FILLING INSTRUMENTS	49	NEEDLE HOLDERS	85-86	RUBBER DAM CLAMPS	89
INTRALIGAMENTAL ANESTHESIA SYRINGE	13	NEUMANN SCISSORS	84	RUBBER DAM CLAMPS FORCEPS	134
IRIS SCISSORS	83-84	NOYES SCISSORS	84	RUSSIAN LONG TISSUE FORCEPS	134
IVORY LIGHT WEIGHT CLAMPS FORCEPS	88	NEEDLE CASE ROUND WITH COVER	150	SCALER TRAY	148
IVORY MATRIX RETAINERS	91	OCCUSAL ANATOMY INSTRUMENT	113	SCALER/CURETTE SETS	60
WANSON SPRING CALIPER	109	OHL PERIOSTEEL ELEVATORS	95	SCALER/CURETTE SETS INSTRUMENTS	61
JACQUETTE SCALERS PERIODONTAL INSTRUMENTS	59	OLSEN-HEGAR NEEDLE HOLDER WITH SCISSORS	51	SCHURE BAND SEATER	97
JARA BEAK PLIER	104	OREGON PLUGGERS/CONDENSERS	98	SEPARATING ELASTIC PLIER	88
JENNINGS CHEEK RETRACTORS	79	ORTHO BAND PUSHER SCALER	97	SELDIN PERIOSTEEL ELEVATORS	95
JOHNSON CONTOURING PLIERS	100	ORTHO INSTRUMENT	98	SELDIN RETRACTOR	82
JONES HAEMOSTATIC FORCEPS	87	ORTHO LIGATURE DIRECTOR SINGLE ENDED	97-98	SELDIN ROOT ELEVATORS	15-18, 25
JOSEPH SCISSORS	84	ORTHO LIGHT BAND PUSHER SCALER	97-98	SELF LOCKING GROOVED	133
KELLY HAEMOSTATIC FORCEPS	87	ORTHO LIGHT DOUBLE ENDED LIGATURE DIRECTOR SCALER	98	SELF-LOCKING TWEEZER	32
KELLY SCISSORS	83-84	ORTHO LIGHT DOUBLE ENDED LIGATURE DIRECTOR	98	SEMKEN TAYLOR TWEEZERS	31
KELLY-RANKIN HAEMOSTATIC FORCEPS	87	ORTHO LIGHT DOUBLE ENDED LIGATURE SCALER/DIRECTOR	98	SICKLE PERIODONTAL INSTRUMENTS	39
KEYS FOR IMPLANT SCREW	139	ORTHO LIGHT LIGATURE DIRECTOR DOUBLE ENDED	98	SICKLE SCALERS INSTRUMENTS	58
KIDNEY TRAY WITH COVER (ENGLISH PATTERN)	148	ORTHO LIGHT SCALER DOUBLE ENDED	97	SINGLE ENDED PROBE	33
KIDNEY TRAYS	148	ORTHO LIGHT SCALER HEAVY	97	SINUS LIFT ELEVATOR	115-116
KILNER (RAGNELL) SCISSORS	84	ORTHO LIGHT SCALER SINGLE ENDED	98	SINUS LIFT INSTRUMENT	118-121
KLEINERT-KUTZ BONE ROUNDER	14	ORTHO LIGHT SCALER	97	SCHWARZ PLIER	106
KOPP ROOTS ELEVATOR	23-24	ORTHODONTIC INSTRUMENTS	96-98	SINUS LIFT SET STAND	147
KRARNER-NEVINS BONE CHISEL	94	ORTHOLITE LIGATURE DIRECTOR SCALER	98	SINUS WINDOW BONE TAMPERS	127
LA GRANGE SCISSORS	83-84	OSTEOMETER MEASURING FORCEPS	96	SINUSLIFT INSTRUMENTS	118
LADMORE FILLING INSTRUMENTS	52	OSTEOTOME CONVEXES / CONCAVE / CONIQUES	135-136	SIOVELAND RETAINERS TOFFLEMIRE-JUNIER MATRIX RETAINERS	91
LADMORE IMPLANTOLOGY INSTRUMENTS	112	OVAL SPOONS/DARBY-PERRY	65	SMAHA ELASTOMERIC LIGATURE PLACING FORCEPS	107
LAP-JOINT THREE PRONG PLIER	106	P.K. THOMAS WAXING INSTRUMENTS	73	SPENCER SCISSORS	84
LAXUTOR ROOT ELEVATORS	19	PALATAL ARCH PLIER	105	SPIRIT LAMP	148
LE CRON CEMENT SPATULAS	75	PALMER CLAMPS FORCEPZ	88	SPOON AND PUSHER (TRINOVO)	128
LESSMANN	76	POL ELEVATORS	28-29	SPOON AND PUSHER WITH SAFETY STOP	128
LIGATURE FORMING PLIERS	101	PEDIATRIC TOOTH EXTRACTING FORCEPS SET	99	SPOONS	64
LIGHT WIRE BIRD BEAK LONG PLIER WITH TC	102	PERIODONTAL FILLING INSTRUMENTS	53	SPREADERS	46
LIGHT WIRE BIRD BEAK LONG PLIER	104	PERIODONTAL INSTRUMENTS	37, 39, 56, 60, 95	STANDARD LIGATURE CUTTER TC	106
LIGHT WIRE BIRD BEAK PLIERS	104	PERIODONTAL PROBES	46, 48	STEP PLIERS WITH TC	103
LIGHT WIRE CUTTER MICRO WITH TC	102	PERIOSTEALS ELEVATOR	95, 129-130	STERILIZING DRUM	148
LIGHT WIRE PLIER	104	PERIOTOME ROOTS ELEVATOR	26	SPIRIT LAMP SINGLE NUT	150
LINDO LEVIAN ROOT ELEVATORS	20	PERRY TWEEZER	31-32	SPIRIT LAMP	150
LINGUAL / PALATAL ARCH FORMING PLIERS	101	PESTERIOR BEND REMOVER PLIER LONG	103	SUCTION CANNULA KIT	151
LINGUAL PLIER LONG HANDLE	106	PESTERIOR BEND REMOVER PLIER MEDIUM	103	STERILIZING CASES STAINLESS STEEL	149
LINGUAL PLIER WEINGART	106	PESTERIOR BEND REMOVER PLIER SHORT	103	STOP V BENDING PLIER	105
LINGUAL WEINGART PLIER	106	PIN & LIGATURE CUTTERS TC	106	STRAIGHT DIRECT BOND BRACKET REMOVER TC	107
LINING APPLICATOR DOUBLE END	55	PIN HOLDING PLIER TC	107	SURGICAL CHISELS	123
LOCKLIN SCISSORS	84	PIN-TWEEZERS	134	SURGICAL FORCEPS	31
LONDON COLLEGE TWEEZERS	31	PLAIN MIRRORS	30	SUTURE PLIERS SUTURE FORCEPS	133
LORNA HAEMOSTATIC FORCEPS	87	PLASTER KNIFE 76 SPECIAL INOX	76	SYNDESMOTOMES ROOTS ELEVATOR	26
LUCAS	132	PLIERS FOR ORTHODONTICS & PROSTHETICS	99-106	TAMPER	126
LUER BONE ROUNDER	14	PLUGGER PERIODONTAL INSTRUMENTS	56	TANNER FILLING INSTRUMENTS	52, 69
LUKS	47	PLUGGER BLACK AMALGAM CARVERS	56	TANNER IMPLANTOLOGY INSTRUMENTS	114
LUXATOR ROOT ELEVATORS	15-16, 21	PLUGGERS	45, 48	TC GRIPPER CARBIDE	133
LUXIER ROOTS ELEVATOR	22	PLUGGERS/CONDENSERS FILLING INSTRUMENTS	50	THARP RESTORATIVE INSTRUMENTS	106
MAGNIFYING MIRRORS	30	PLUGGERS/CONDENSERS	51	THREE PRONG PLIERS REGULAR	106
MANUAL CROWN REMOVER	90	POINTED CURETTE	60	TISSUE GRAFT FORCEP SERRATED TEETH	133
MARCOTTE LOOPING PLIER	105	POINTED PROBES SINGLE ENDED	36	TISSUE MEMBRANE FORCEPS	132, 134
MARGIN TRIMMERS	72	POSTERIOR	48	TISSUE PUNCH FORCEPS	134
MARGINAL RIDGE & EMBRASURE SHAPING INSTRUMENT	113	POSTERIOR BAND REMOVER PLIERS	102	TISSUE PUNCH STRAIGHT & CURVED	138
MARKLEY PLUGGERS/CONDENSERS	51	POTT ROOTS ELEVATOR	25	TOFFLEMIRE-SENIOR MATRIX RETAINERS	91
MARQUETTE FILLING INSTRUMENTS	50	POWER CROWN REMOVER LIFT	90	TOFFLEMIRE-UNIVERSAL MATRIX RETAINERS	91
MARYAM TWEEZERS	32	PRICHARD PERIOSTEEL ELEVATORS	95	TORQUE WRENCH & RATCHET	139
MATHEU NEEDLE HOLDERS	86	PROBES DOUBLE ENDED	35	TOWNER PERIODONTAL INSTRUMENTS	58
MATRIX RETAINERS	91	PROBES SINGLE ENDED	34	TOWNER-JACQUETTE PERIODONTAL INSTRUMENTS	58
MAYO NEEDLE HOLDERS	85	QUETIN FILLING INSTRUMENTS	49	TREPHINE DRILL SET OF EIGHT PIECES	137
MAYO SCISSORS	83	RASPATOR, BENQUE	131	TUFTS FILLING INSTRUMENTS	49
MAYO-HEGAR NEEDLE HOLDERS	85-86	RASPATOR, FREER	129, 131	TUNNELIERS INSTRUMENT	126
MEAD 1A BONE ROUNDER	14	RASPATOR, MICRO FREER	131	TWEED / ANGLE FORMING AND TORQUING PLIERS	101
MEAD BONE FILES	94	RASPATOR, MICRO RASPATOR / CHISEL	131	TWEED / ANGLE RECTANGULAR ARCH FORMING & TORQUING PLIERS	100
MEASURING LOOP	109	RASPATOR, MICRO-FREER	129	TWEED ARCH FORMING PLIER TC	102
MEASURING LOOP, CASTROVIEJO	109	RASPATOR, NORDBERG	131	TWEED CUTTER PLIER	104
MEDIUM CEMENT CEMENT SPATULAS	75	RASPATOR, PRICHARD	124	TWEED LOOP FORMIN PLIERS	100
MEDIUM PLACING/CONDENSING IMPLANTOLOGY INSTRUMENTS	114	RASPATOR, RASPIRY PERIOSTEEL ELEVATORS	95	TWEED LOOP FORMING PLIER TC	105
MEMBRANE POSITIONING INSTRUMENTS	118	RASPATOR, WAUTIER	131	TWEED LOOP FORMING PLIERS	99
MEMBRANE TWEEZERS KUEHNE	134	RASPATOR, WILLIGER PERIOSTEEL ELEVATORS	95	TWEED LOOP PLIER	104-105
MERIAM TWEEZERS	31	RUBBER DAM FRAME	88	TWEezer PERIODONTAL INSTRUMENTS	39
MERRIT A EXPLORERS	36	RASPATORY CHIPPING	131	TWEEZERS	31
MERRIT B EXPLORERS	36	RASPATORY MICRO MOLT	131	TWEEZERS	32
MERSHON CROWN REMOVER	90	RASPATORY MOLT	131	TWIEL-ON ELASTIC MODULE INSTRUMENT	97
METZENBAUM NEEDLE HOLDERS	85	REGULAR TWEED ARCH FORMING PLIERS	104	UNIVERSAL DOLPHIN STYLE WIRE BENDING & CUTTING PLIERS	99
METZENBAUM SCISSORS	83	RESTORATIVE INSTRUMENTS	51-53, 68, 70-72	UNIVERSAL FILLING INSTRUMENTS	49
MICOR ADSON TISSUE FORCEP	133	RETRACTOR WITH ERGO GRIP	90	UNIVERSAL FILLING INSTRUMENTS	54
MICRO IRIS SCISSORS	83	RETRACTORS - MOUTH GAGS	78-79	UNIVERSAL NEEDLE HOLDERS	85
MICRO-FRIEDMAN BONE ROUNDER	14	RETRACTORS	80-82	UNIVERSITY OF MICHIGAN EXPLORERS	36
MILLER BONE FILES	94	RETRACTORS CHEEK RETRACTOR COMBINATION COMBINATION	80	UTILITY PLIER WEINGART TC	107
MILLER TWEEZERS	32	RETRACTORS COMBINATION	81	V BEND STOP PLIER TC	106
MILLER	132	RETRACTORS, LANGENBECK	82	W. BARRY ROOTS ELEVATOR	25
MINI LIGATURE CUTTERS	100	RETRACTORS, MINI-LANGENBECK	81	URINAL FEMALE, URINAL MALE, URINAL MALE VERTICAL	150
MINI PIN & LIGATURE CUTTER TC	106	RETRACTORS, UNIQUE	81	WAHL BONE FILES	94
MIXING SPATULA WITH SHOVEL	124	RETRO FILLING	48	WALDSAVHS WIRE BENDING AND CUTTING PLIERS	101
MODIED MCALL	60	REVERSED LIGATURE CUTTER ANGLED	102	WALL FILLING INSTRUMENTS	69
MOLT BONE FILES	94	RHODIUM MIRRORS	30	WANGEN HOLDER	79
MOLT PERIOSTEEL ELEVATORS	95	ROCHESTER-KOCHER 1X2 HAEMOSTATIC FORCEPS	87	WARD AMALGAM CARVERS	58
MORTONSEN FILLING INSTRUMENT	55	ROCHESTER-PEAN HAEMOSTATIC FORCEPS	87	WARD FILLING INSTRUMENTS	89
MOUTH GAG MOLT	78	ROOT ELEVATOR	15-29	WAX KNIVES	76
MOUTH MIRROR	37	ROOT PLANNING FILES	94	WEDELSTADT	71
MSY CEMENT SPATULAS	75	ROOT PLANNING FILES & BONE FILES	94	WEINGART GENERAL UTILITY PLIER LONG MOUTH WITH TC	103
MULTIFUNCTIONAL METER	108	ROOTS ELEVATOR	22	WEINGART PLIER MEDIUM	99-101
MISCELLANEOUS PRODUCTS	740	ROSER-KONIG CHEEK RETRACTORS	79		
NAKAWALN DENTAL LABORATORY INSTRUMENTS	77				



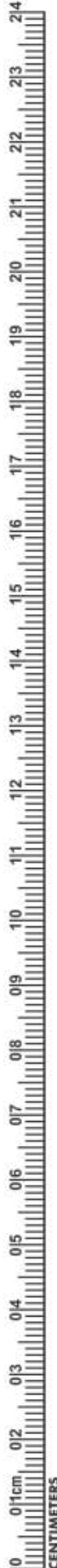

DESCRIPTION	PAGE #	DESCRIPTION	PAGE #	DESCRIPTION	PAGE #
WEINGART PLIER REGULAR WITH TC	103				
WEINGART PLIER SLIM WITH TC	102				
WEINGART PLIER UNIVERSAL WITH TC	103				
WEINGART PLIER UTILITY WITH TC	103				
WEITLANDER CHEEK RETRACTORS	79				
WEITLANDER CHEEK RETRACTORS	79				
WERDELSTAEDT FILLING INSTRUMENTS	74				
WESTON CEMENT SPATULAS	75				
WIDE MATRIX RETAINERS	91				
WILLIAM PROBE SET	38				
WILLIAMS EXPLORERS	36				
WINGURT PLIER SLIM	105				
WINGURT UTILITY PLIER	105				
WINTER ROOTS ELEVATOR	25				
WIRE BENDING & LOOP FORMING PLIERS	99				
WISDOM ROOTS ELEVATOR	21				
WOODEN HANDLE	76				
WOODSON FILLING INSTRUMENTS	49				
YOUNG PLIER WITH GROOVED	105				
YOUNG TONGUE FORCEPS	99				
YOUNG WIRE BENDING & LOOP FORMING PLIERS	99				
ZAHLE CEMENT SPATULAS	75				



FISKER
 INSTRUMENTS



FISKER
INSTRUMENTS

**Manufacturers & Exporters of Surgical, Dental, Orthodontic,
Hollow Wears & Manicure Instruments.**

Defance Road, Hadi Town Near Jamia Qadria Sialkot-Pakistan

P.O. Box. 322 Sialkot 51310 Pakistan

Contact No. +92-324-0087186 +92-346-6652776

E-mail: info@fiskerinstruments.com

www.fiskerinstruments.com

